

VI TELEFILTER

Filter specification

TFS 70AM

Measurement condition :

Ambient temperature T_A : 23 °C
 Input power level: 0 dBm
 Terminating impedances at f_C *) :
 for input: 155 Ω || -19,4 pF (preliminary values)
 for output: 200 Ω || -14,0 pF (preliminary values)

Characteristics

Remark:

The reference level for the relative attenuation a_{rel} of the TFS 70AM is the minimum of the pass band attenuation a_{min} . The minimum of the pass band attenuation a_{min} is defined as the insertion loss a_e . The nominal frequency f_N is fixed at 70 MHz. The values for relative attenuation are guaranteed at ambient temperature. The frequency shift of the filter over temperature defined by the temperature coefficient of frequency T_{Cf} is not included in the production tolerance scheme.

D a t a		typ. value		tolerance / limit	
Insertion loss : (reference level)	a_e	10	dB	max. 11	dB
Nominal frequency :	f_N	-		70	MHz
Centre frequency :	f_C at ambient temperature (f_{CTA})	70	MHz		
Pass band :	PB	-		$f_N \pm 4,5$	MHz
Relative attenuation :	a_{rel}				
$f_N \dots f_N \pm 3,5$ MHz		1,0	dB	max. 1,5	dB **
$f_N \pm 3,5$ MHz ... $f_N \pm 4,0$ MHz		1,8	dB	max. 3	dB
$f_N \pm 5,0$ MHz ... $f_N \pm 8,0$ MHz		25	dB	min. 20	dB
$f_N \pm 8,0$ MHz ... $f_N \pm 50$ MHz		38	dB	min. 35	dB
Group delay (mean value in PB) : **/***		2,0	μ s	max. 2,2	μ s
Group delay ripple (p-p) in PB : **/***		150	ns	max. 300	ns
Temperature coefficient of frequency (T_{Cf})		- 72	ppm/K	-	
Frequency deviation of f_C over temperature		$\Delta f_C(\text{Hz}) = T_{Cf}(\text{ppm/K}) \times (T - T_{CTA}) \times f_{CTA} (\text{MHz})$			
Operating temperature range	OTR			- 40 °C ... + 80 °C	
Storage temperature range				- 40 °C ... + 85 °C	

*) The terminating impedances depend on parasitics and q-values of matching elements and the board used, and are to be understood as reference values only. Should there be additional questions do not hesitate to ask for an application note or contact our design team.

**) A cascade of TFS70AK and TFS70AM will have triple transit signal cancellation offering reduced group delay and amplitude ripple of the cascade.

***) for a cascade of TFS 70AK and TFS70AM

Generated:

Checked / Approved:

Tele Filter GmbH
Potsdamer Straße 18
D 14 513 TELTOW / Germany
Tel: (+49) 3328 4784-0 / Fax: (+49) 3328 4784-30
E-Mail: tft@telefilter.com

VI TELEFILTER reserves the right to make changes to the product(s) and/or information contained herein without notice. No liability is assumed as a result of their use or application. No rights under any patent accompany the sale of any such product(s) or information.

Filter characteristic cascade of TFS70AK and TFS70AM

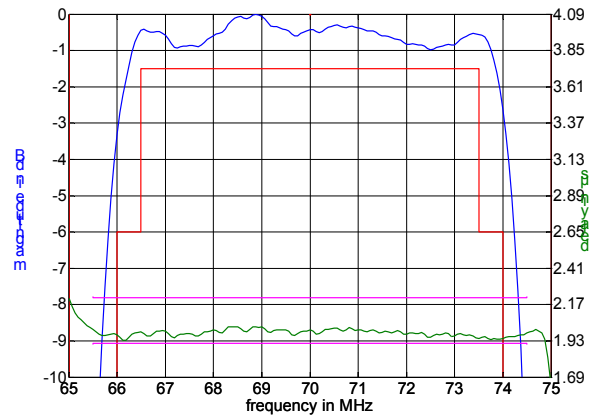
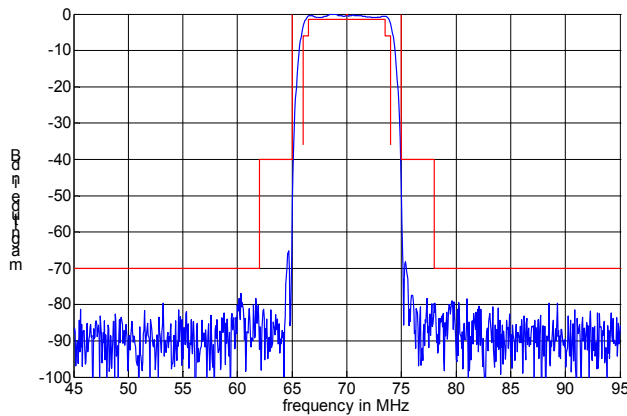

Construction and pin connection

(All dimensions in mm)

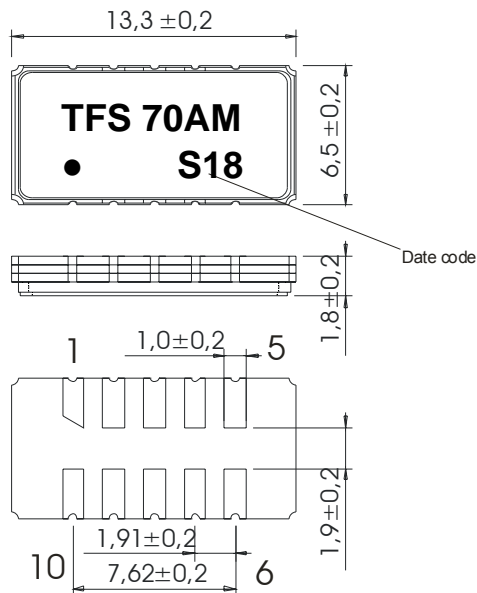

- 1 Input
- 2 Ground
- 3 Ground
- 4 Ground
- 5 Output RF Return
- 6 Output
- 7 Ground
- 8 Ground
- 9 Ground
- 10 Input RF Return

Date code: Year + week
 S 2004
 T 2005
 U 2006
 ...

50 Ohm Test circuit

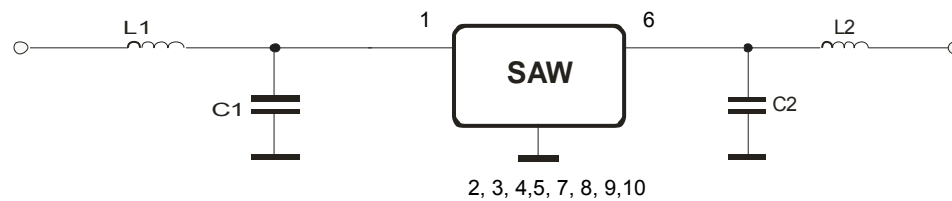

Tele Filter GmbH
 Potsdamer Straße 18
 D 14 513 TELTOW / Germany
 Tel: (+49) 3328 4784-0 / Fax: (+49) 3328 4784-30
 E-Mail: tft@telefilter.com

VI TELEFILTER reserves the right to make changes to the product(s) and/or information contained herein without notice. No liability is assumed as a result of their use or application. No rights under any patent accompany the sale of any such product(s) or information.

Stability characteristics

After the following tests the filter shall meet the whole specification:

1. Shock: 500g, 18 ms, half sine wave, 3 shocks each plane;
DIN IEC 68 T2 - 27
2. Vibration: 10 Hz to 500 Hz, 0,35 mm or 5 g respectively, 1 octave per min, 10 cycles per plan, 3 plans;
DIN IEC 68 T2 - 6
3. Change of temperature: -55 °C to 125°C / 30 min. each / 10 cycles
DIN IEC 68 part 2 – 14 Test N
4. Resistance to solder heat (reflow): reflow possible: twice max.;
for temperature conditions refer to the attached "Air reflow temperature conditions" on page 4;

Packing

Tape & Reel: IEC 286 – 3, with exception of value for N and minimum bending radius;
tape type II, embossed carrier tape with top cover tape on the upper side;

max. pieces of filters peer reel: 1700
reel of empty components at start: min. 300 mm
reel of empty components at start including leader: min. 500 mm
trailer: min. 300 mm

Tape (all dimensions in mm)

- W : 24,00 +0,30/-0,10
- Po : 4,00 ± 0,1
- Do : 1,50 +0,1/-0
- E : 1,75 ± 0,10
- F : 11,50 ± 0,10
- G(min) : 0,60
- P2 : 2,00 ± 0,1
- P1 : 12,00 ± 0,1
- D1(min) : 1,50
- Ao : 7,10 ± 0,10
- Bo : 13,90 ± 0,10
- Ct : 21,5 ± 0,1

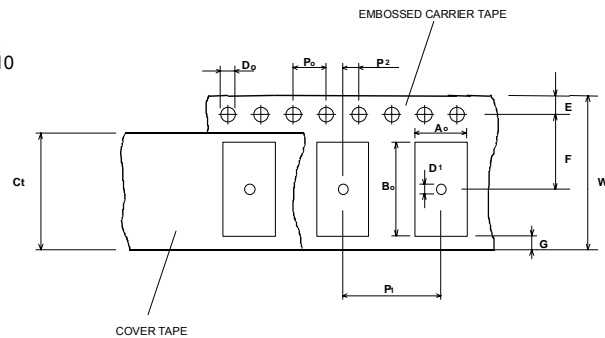

Reel (all dimensions in mm)

- A : 330
- W1 : 24,4 +2/-0
- W2(max) : 30,4
- N(min) : 60
- C : 13,0 +0,5/-0,2

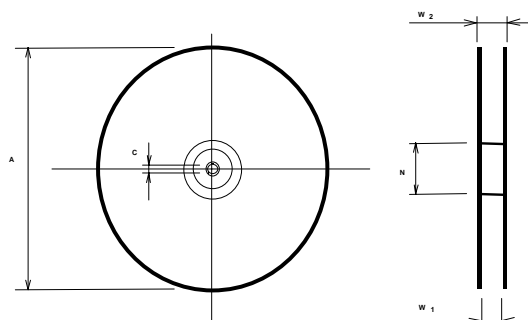

The minimum bending radius is 45 mm. The mounting surface of the filters faces the bottom side of the embossed carrier tape. Marking of the filters can be read if the upper side of the carrier tape is regarded with the sprocket holes on the right.

Tele Filter GmbH
Potsdamer Straße 18
D 14 513 TELTOW / Germany
Tel: (+49) 3328 4784-0 / Fax: (+49) 3328 4784-30
E-Mail: tft@telefilter.com

VI TELEFILTER reserves the right to make changes to the product(s) and/or information contained herein without notice. No liability is assumed as a result of their use or application. No rights under any patent accompany the sale of any such product(s) or information.

Air reflow temperature conditions

1st and 2nd air reflow profile

Name:	pre-heating periods	main-heating periods	peak temperature
Temperature:	150 °C - 170 °C	over 200 °C	255 °C ± 5 °C
Time:	60 sec. - 90 sec.	20 sec. - 25 sec.	

Chip-mount air reflow profile

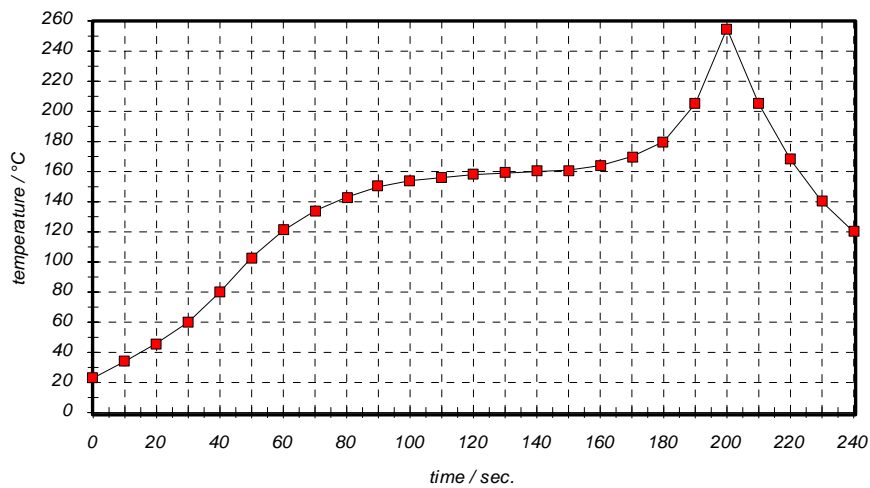

Table for temperature vs. time during the air reflow process

Tolerance of temperatures: ± 5 °C

time / sec.	temperature / °C	time / sec.	temperature / °C
0	23	140	160
10	34	150	161
20	46	160	164
30	60	170	170
40	80	180	180
50	103	190	205
60	121	195	230
70	134	200	255
80	143	205	230
90	150	210	205
100	154	215	180
110	156	220	165
120	158	230	140
130	159	240	120

VI TELEFILTER**Filter specification****TFS 70AM****5/5**

History :

Version	Reason of Changes	Name	Date
1.0	- filter specification generated	Pfeiffer	26.04.2004

Tele Filter GmbH
Potsdamer Straße 18
D 14 513 TELTOW / Germany
Tel: (+49) 3328 4784-0 / Fax: (+49) 3328 4784-30
E-Mail: tft@telefilter.com

VI TELEFILTER reserves the right to make changes to the product(s) and/or information contained herein without notice. No liability is assumed as a result of their use or application. No rights under any patent accompany the sale of any such product(s) or information.