



SANYO Semiconductors

DATA SHEET

LA4814V — Monolithic Linear IC 2-Channel Power Amplifier

Overview

The LA4814V built-in the power amplifier circuit capable of low-voltage (2.7V and up) operation and has additionally a standby function to reduce the current drain. It is a power amplifier IC optimal for speaker drive used in battery-driven portable equipment and other such products.

Applications

Mini radio cassette players/recorders, portable radios, transceivers and other portable audio devices

Features

- On-chip 2-channel power amplifier
 - Output power 1 = 350mW typ. ($V_{CC} = 5.0V$, $R_L = 4\Omega$, THD = 10%)
 - Output power 2 = 150mW typ. ($V_{CC} = 3.6V$, $R_L = 4\Omega$, THD = 10%)
- Enables monaural BTL output system by changing externally connected components
 - Output power 3 = 700mW typ. ($V_{CC} = 5.0V$, $R_L = 8\Omega$, THD = 10%)
 - Output power 4 = 320mW typ. ($V_{CC} = 3.6V$, $R_L = 8\Omega$, THD = 10%)
- Low-voltage operation possible
 - $V_{CC} = 2.7V$ and up
- Standby function
 - Current drain at standby = 0.1 μ A typ. ($V_{CC} = 5V$)
- Voltage gain setting possible
 - Voltage gain = 3 to 20dB
- Second amplifier stop control function
 - Reducing the pop noise at startup (in BTL mode)

■ Any and all SANYO Semiconductor Co.,Ltd. products described or contained herein are, with regard to "standard application", intended for the use as general electronics equipment (home appliances, AV equipment, communication device, office equipment, industrial equipment etc.). The products mentioned herein shall not be intended for use for any "special application" (medical equipment whose purpose is to sustain life, aerospace instrument, nuclear control device, burning appliances, transportation machine, traffic signal system, safety equipment etc.) that shall require extremely high level of reliability and can directly threaten human lives in case of failure or malfunction of the product or may cause harm to human bodies, nor shall they grant any guarantee thereof. If you should intend to use our products for applications outside the standard applications of our customer who is considering such use and/or outside the scope of our intended standard applications, please consult with us prior to the intended use. If there is no consultation or inquiry before the intended use, our customer shall be solely responsible for the use.

■ Specifications of any and all SANYO Semiconductor Co.,Ltd. products described or contained herein stipulate the performance, characteristics, and functions of the described products in the independent state, and are not guarantees of the performance, characteristics, and functions of the described products as mounted in the customer's products or equipment. To verify symptoms and states that cannot be evaluated in an independent device, the customer should always evaluate and test devices mounted in the customer's products or equipment.

SANYO Semiconductor Co., Ltd.

TOKYO OFFICE Tokyo Bldg., 1-10, 1 Chome, Ueno, Taito-ku, TOKYO, 110-8534 JAPAN

LA4814V

Specifications

Maximum Ratings at $T_a = 25^\circ\text{C}$

Parameter	Symbol	Conditions	Ratings	Unit
Maximum supply voltage	V_{CC} max		8	V
Allowable power dissipation	P_d max	*	1.85	W
Maximum junction temperature	T_j max		150	$^\circ\text{C}$
Operating temperature	T_{opr}		-40 to +85	$^\circ\text{C}$
Storage temperature	T_{stg}		-40 to +150	$^\circ\text{C}$

* Mounted on SANYO evaluation board : Double-sided board with dimensions of 60mm × 60mm × 1.6mm

Operating Conditions at $T_a = 25^\circ\text{C}$

Parameter	Symbol	Conditions	Ratings	Unit
Recommended supply voltage	V_{CC}		5	V
Recommended load resistance	RL	Single ended mode	4 to 32	Ω
		BTL mode	6 to 32	Ω
Operating supply voltage range	V_{CC} op	Single ended mode	2.7 to 7	V
		BTL mode, $R_L = 8$ to 32Ω	2.7 to 7	V
		BTL mode, $R_L = 6\Omega$	2.7 to 5.5	V

* Determine the supply voltage to be used with due consideration of allowable power dissipation.

Electrical Characteristics at $T_a = 25^\circ\text{C}$, $V_{CC} = 5.0\text{V}$, $R_L = 4\Omega$, $f_{in} = 1\text{kHz}$

Parameter	Symbol	Conditions	Ratings			Unit
			min	typ	max	
Quiescent current drain	I_{CCOP}	No signal		8.6	15	mA
Standby current drain	ISTBY	No signal, V8 = Low		0.1	10	μA
Maximum output power	POMAX	THD = 10%	220	350		mW
BTL maximum output power	POMXB	BTL mode, $R_L = 8\Omega$, THD = 10%		700		mW
Voltage gain	VG	$V_{IN} = -30\text{dBV}$	8.2	9.7	11.2	dB
Voltage gain use range	VGU		3		20	dB
Channel balance	CHB	$V_{IN} = -30\text{dBV}$	-2	0	2	dB
Total harmonic distortion	THD	$V_{IN} = -30\text{dBV}$		0.35	1	%
Output noise voltage	VNOUT	$R_g = 620\Omega$, 20 to 20kHz		15	50	μVrms
Channel separation	CHSEP	$V_{OUT} = -10\text{dBV}$, 20 to 20kHz	-70	-81		dBV
Ripple rejection ratio	SVRR	$R_g = 620\Omega$, $f_r = 100\text{Hz}$, $V_r = -20\text{dBV}$		53		dB
Output DC offset voltage	VOF	$R_g = 620\Omega$, V3-V12, in BTL mode	-30	0	30	mV
Reference voltage	VREF			2.2		V
Pin 8 control HIGH voltage	V8H	(Power amplifier operation mode)	1.6		V_{CC}	V
Pin 8 control LOW voltage	V8L	(Power amplifier standby mode)	0		0.3	V
Pin 9 control HIGH voltage	V9H	(Second amplifier standby mode)	1.6		V_{CC}	V
Pin 9 control LOW voltage	V9L	(Second amplifier operation mode)	0		0.3	V

LA4814V

Package Dimensions

unit : mm (typ)
3313

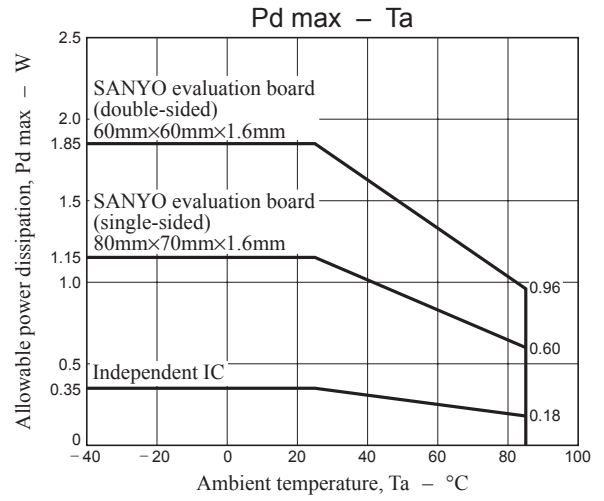
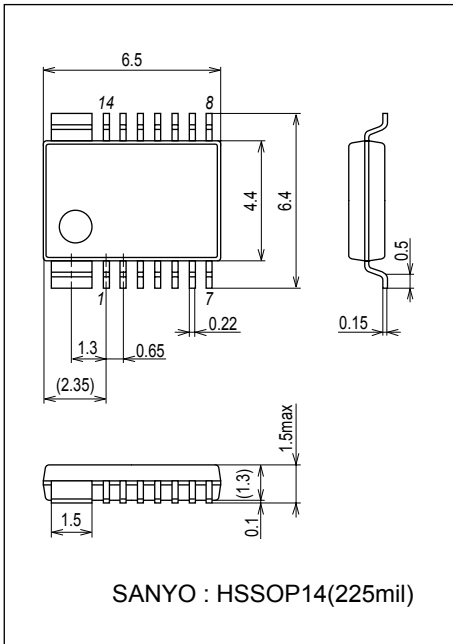

Block Diagram

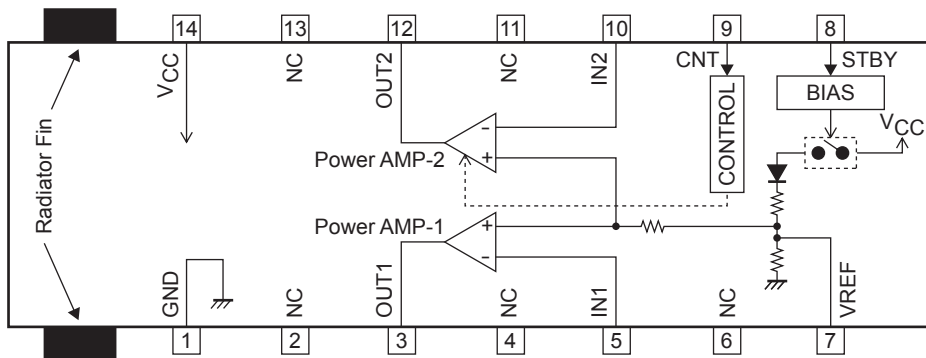

LA4814V

Pin Functions

Pin No.	Pin Name	Pin Voltage	Description	Equivalent Circuit
		$V_{CC} = 5V$		
1	GND	0	Ground pin	
2	NC			
3 12	OUT1 OUT2	2.2	Power amplifier output pin	
4	NC			
5 10	IN1 IN2	2.2	Input pin	
6	NC			
7	VREF	2.2	Ripple filter pin (For connection of capacitor for filter)	
8	STBY		Standby pin Standby mode at 0V to 0.3V Operation mode at 1.6V to V_{CC}	
9	CNT		Second amplifier stop control pin Second amplifier operation at 0V to 0.3V Second amplifier stop at 1.6V to V_{CC}	
11	NC			
13	NC			
14	V_{CC}	5	Power supply pin	

Cautions for Use

1. Input coupling capacitors (C1, C2)

C1 and C2 are input coupling capacitors that are used to cut DC voltage. However, the input coupling capacitor C1 (C2) and input resistor R1 (R2) make up the high-pass filter, attenuating the bass frequency. Therefore, the capacitance value must be selected with due consideration of the cut-off frequency.

The cut-off frequency is expressed by the following formula :

$$f_c = 1/2 \pi \times R1 \times C1 (= 1/2 \pi \times R2 \times C2)$$

Note with care that this capacitance value affects the pop noise at startup. To increase this capacitance value, it is necessary to increase the capacitance value of pin 7 capacitor (C5) to soften the startup characteristics.

2. Pin 7 capacitor (C5)

This capacitor C5 is designed for the ripple filter. Its purpose is to make up a low-pass filter with a 100kΩ internal resistor for reducing the ripple component of the power supply and improve the ripple rejection ratio.

Inside the IC, the startup characteristics of the pin 7 voltage are used to drive the automatic pop noise reduction circuit, and care must be taken with the pop noise when the C5 capacitance value is to be set lower.

However, when the IC is used in BTL mode, the automatic pop noise reduction function mentioned above has no effect. Instead, a pop noise reduction method that utilizes the second amplifier control function is used so that the capacitance value must be determined while factoring in the ripple rejection ratio or startup time.

Recommended capacitance value : Min. 22μF (in 2-channel mode)
10μF (in mono BTL mode)

3. Bypass capacitor (C7)

The purpose of the bypass capacitor C7 is to reject the high-frequency components that cannot be rejected by the power supply capacitor (chemical capacitor C6). Place the capacitor as near to the IC as possible, and use a ceramic capacitor with excellent high-frequency characteristics.

4. Standby function

The standby function serves to place the IC in standby mode to minimize the current drain.

a) When using the standby function (when using microcomputer control)

By applying the following voltages to the standby pin (pin 8), the mode changeover can be performed between standby and operation.

Operation mode ... $V8 \geq 1.6V$
Standby mode ... $V8 \leq 0.3V$

However, set the resistance of resistor R5 inserted in series in such a way that the condition in the following formula is met.

$$R5 \leq 24.6 \times (V_{stby} - 1.6) \text{ k}\Omega$$

The pin 8 inrush current is expressed by the following formula:

$$I8 = (40 \times V_{stby} - 26.3) / (1 + 0.04 \times R5) \mu A$$

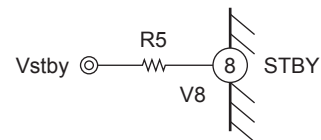

Fig. 1

b) When not using the standby function (microcomputer control is not possible)

By applying a voltage from the power supply (pin 14) to the standby pin (pin 8), the IC can be turned on without the control of the microcomputer when the power is turned on.

In order to reduce the pop noise when the IC is turned off, it is recommended that resistor R5 be inserted as shown in Fig.2. The resistance value indicated below is recommended for the inserted resistor R5.

$V_{CC} = 5.0V : R5 = 82k\Omega$
 $V_{CC} = 3.6V : R5 = 47k\Omega$
 $V_{CC} = 3.0V : R5 = 33k\Omega$

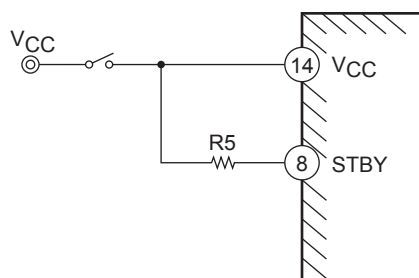

Fig. 2

LA4814V

5. Second amplifier control function (only when BTL mode is used)

The second amplifier control function is a function to reduce the startup pop-noise in BTL mode. The pop noise can be reduced by first turning on the IC while the second amplifier is stopped, then after the potential inside the IC gets stabilized, turning on the second amplifier.

The values shown below are recommended for the control time.

C5 [μF]	2.2	3.3	4.7	10
Twu [ms]	200	250	300	500

* Twu : Time after releasing standby to second amplifier turn-on

a) When using microcomputer control

The second amplifier can be controlled by applying the following voltages to pin 9.

Second amplifier operation mode ... $V9 \leq 0.3\text{V}$

Second amplifier stop mode ... $V9 \geq 1.6\text{V}$

However, set the resistance value of the resistor R6 inserted in series in such a way that the condition in the following formula is met.

$$R6 \leq 16.2 \times (V_{\text{cnt}} - 1.6) \text{ k}\Omega$$

The pin 9 injected current is expressed by the following formula :

$$I9 = (57.6 \times V_{\text{cnt}} - 31.7) / (1 + 0.058 \times R6) \mu\text{A}$$

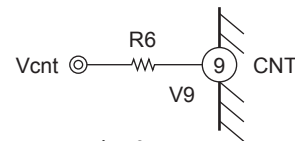

Fig. 3

b) When microcomputer control is not possible

When the microcomputer cannot be used, the second amplifier can be controlled by adding the external components as shown in Fig. 4.

	V_{CC} (V)		
	5	3.6	3
R7 (k Ω)	10	6.8	6.8
R9 (k Ω)	120	68	56
C8 (μF)	100	100	100

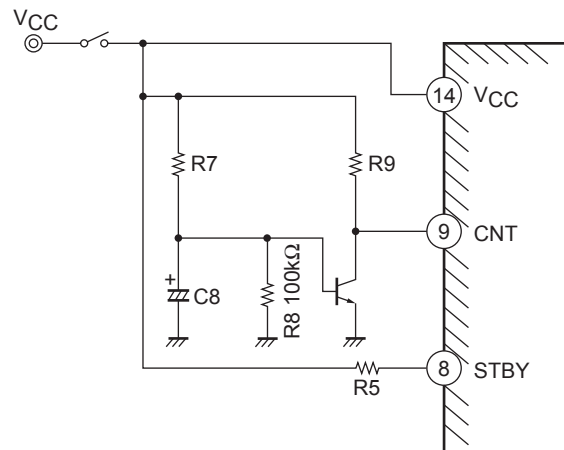

Fig. 4

6. Shorting between pins

When power is applied with pins left short-circuited, electrical deterioration or damage may result.

Therefore, check before power application if pins are short-circuited with solder, etc. during mounting of IC.

7. Load shorting

If the load is left short-circuited for a long period of time, electrical deterioration or damage may occur.

Never allow the load to short-circuit.

8. Maximum rating

When IC is used near the maximum rating, there is a possibility that the maximum rating may be exceeded even under the smallest change of conditions, resulting in failure. Take sufficient margin for variation of supply voltage and use IC within a range where the maximum rating will never be exceeded.

9. Turn-off transient response characteristics

If the IC is turned off and then turned back on while there is a potential difference between the pin 7 (reference voltage, plus input pin) and pins 5 and 10 (minus input pins), a louder pop noise than the one normally generated when power is switched on will be emitted. Therefore, in order to minimize the turn-on pop noise, smoothen the discharge of the input and output capacitors, and bring the potential of pin 7 and pins 5 and 10 to approximately the same level, then turn on the IC.

a) Single ended mode

When the continuous changeover of mode between standby and operation is necessary, it is recommended to insert a resistor between the output pins (pins 3 and 12) and ground to accelerate the turn-off transient response characteristic. The value shown below is recommended for the resistor used for discharge. In order to reduce pop noise, it is recommended that time necessary for turning the IC back on is greater than the following value.

Recommended discharge resistor : $R = 4.7\text{k}\Omega$
 (Recommended turn-on time : $T = 600\text{ms}$)

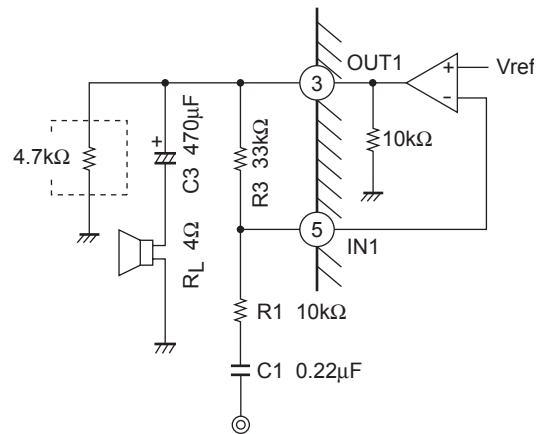
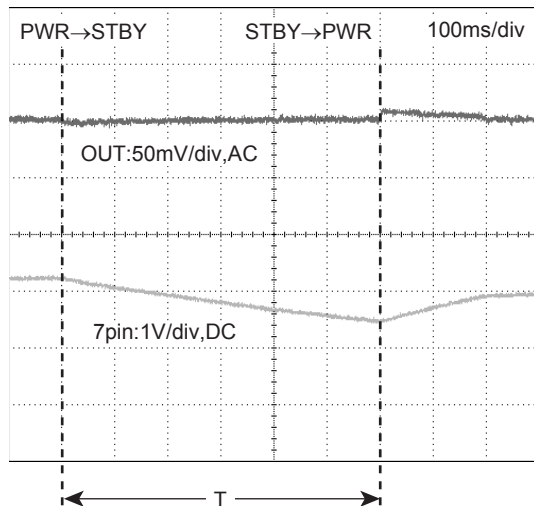

b) BTL mode

When the continuous changeover of mode between standby and operation is performed, it is recommended that the second amplifier control function be used to reduce the turn-on pop noise. If this function is used, the pop noise level can be reduced regardless of the time taken for the IC to turn on after it is turned off.

For details on the time taken for the second amplifier to turn on after the IC is turned on, refer to Section 5 “Second amplifier control function.”

LA4814V

Application Circuit Example 1. (2-channel single ended mode)

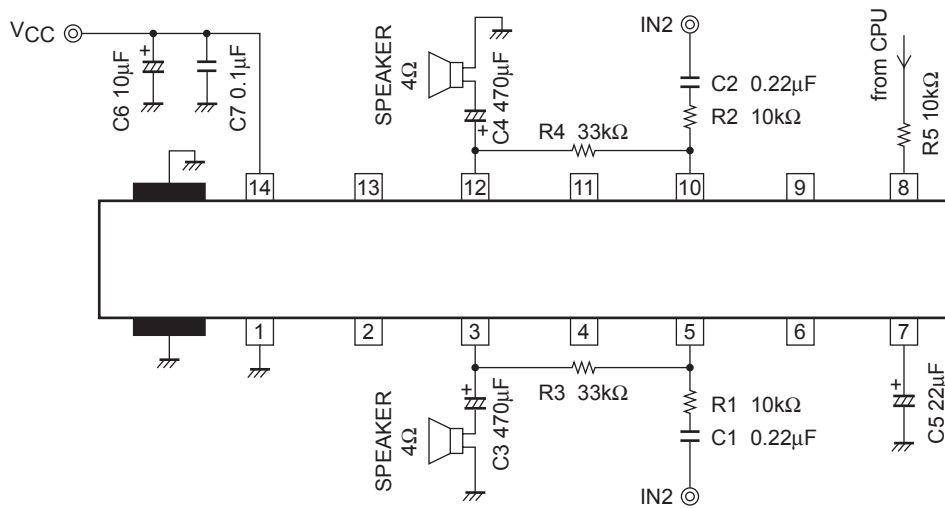

Application Circuit Example 2. (monaural BTL mode)

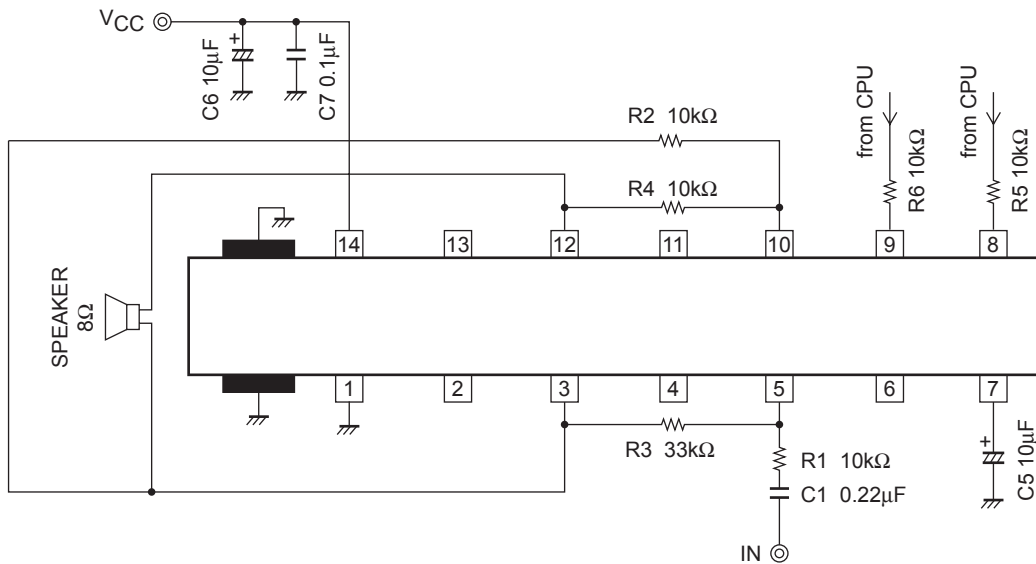

LA4814V

Test Circuit

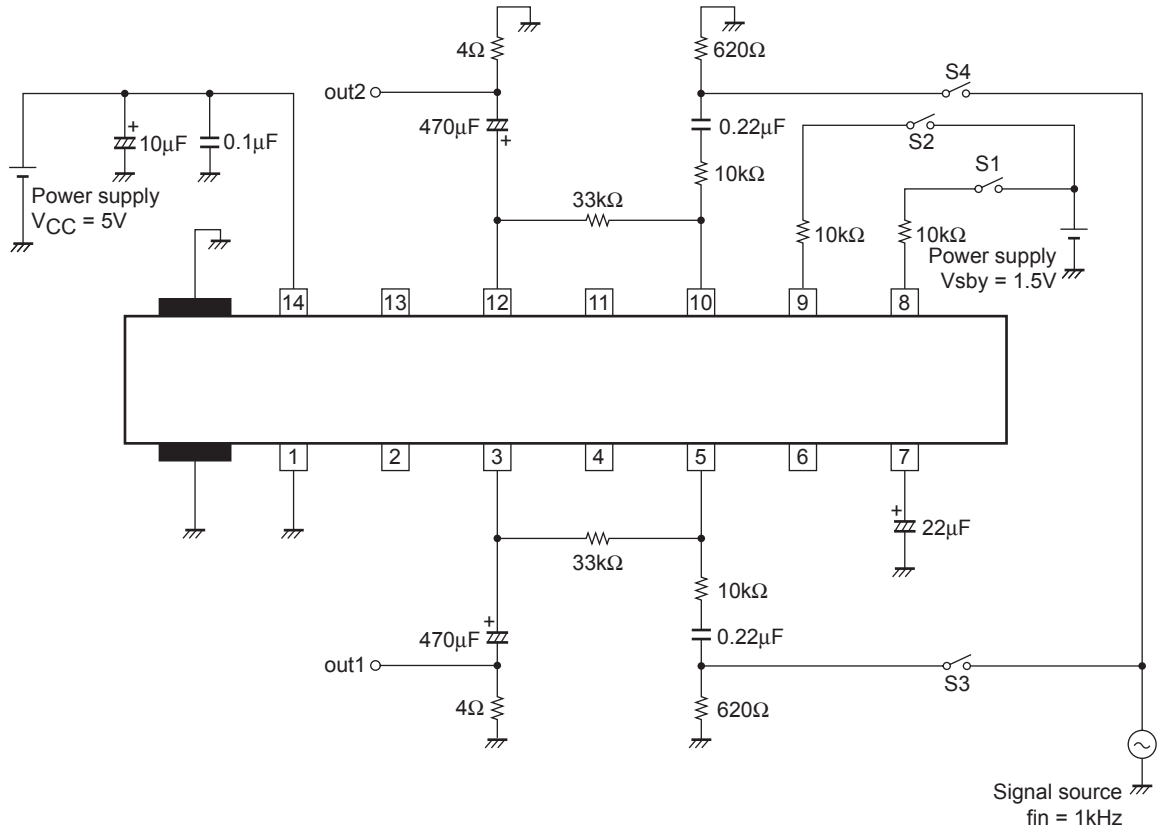

General characteristics Single ended mode

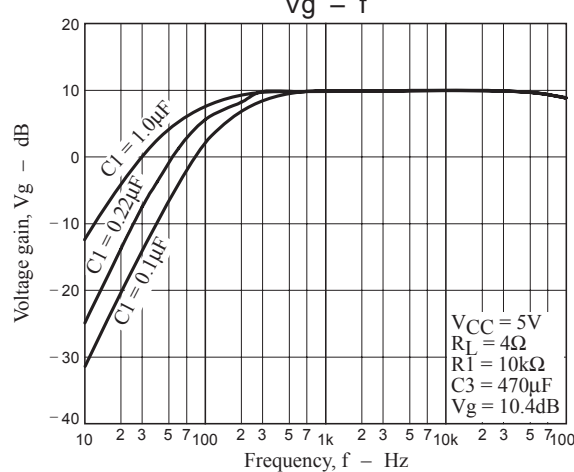
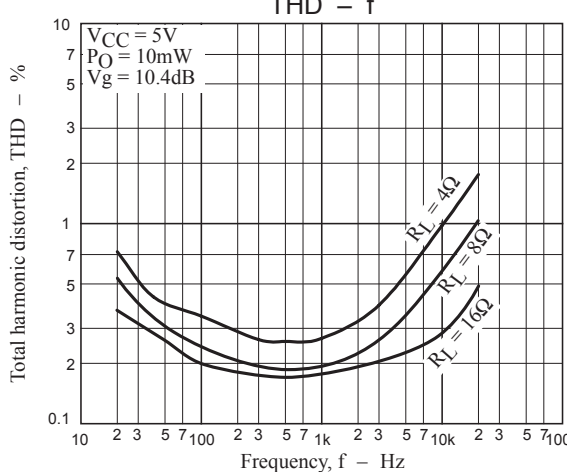
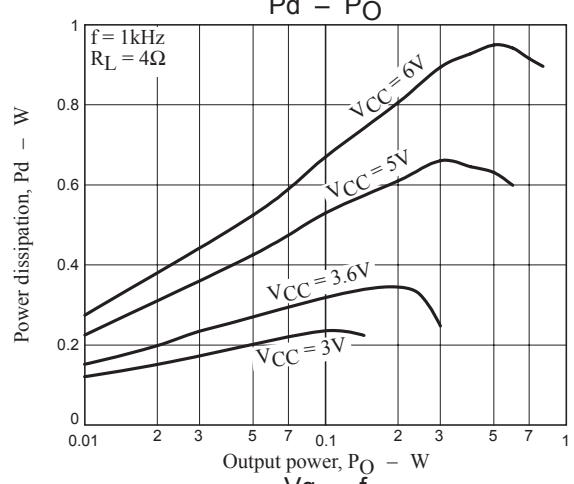
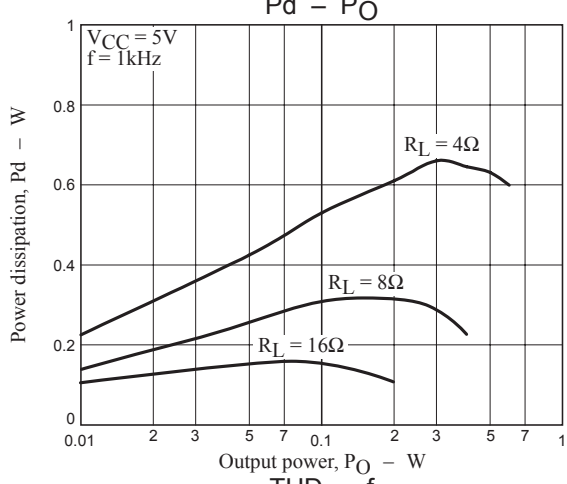
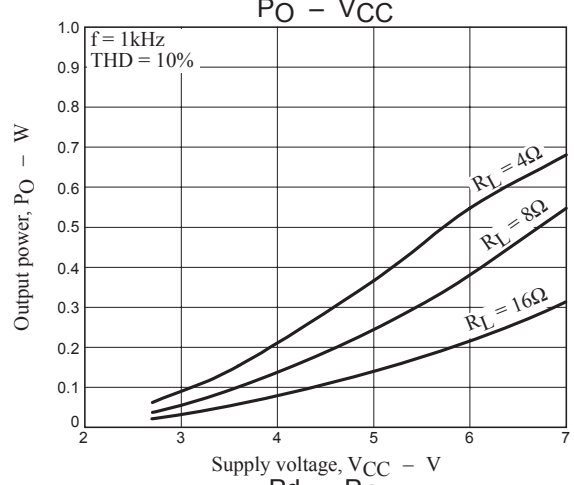
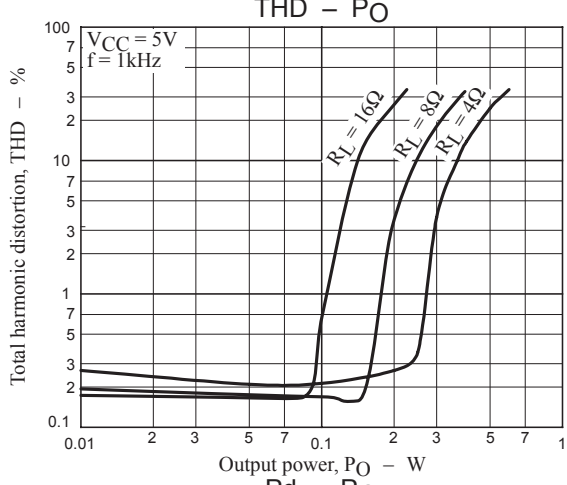
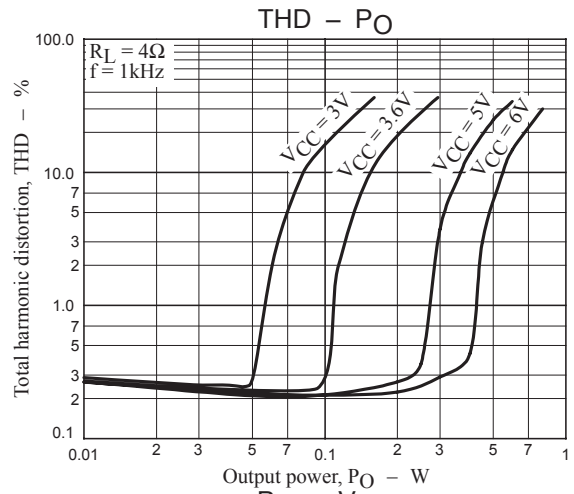
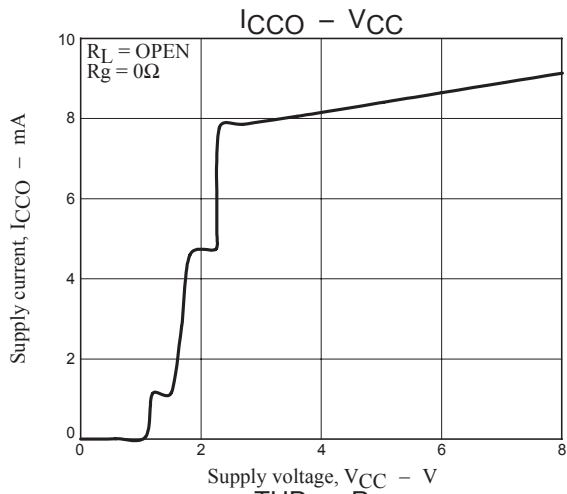

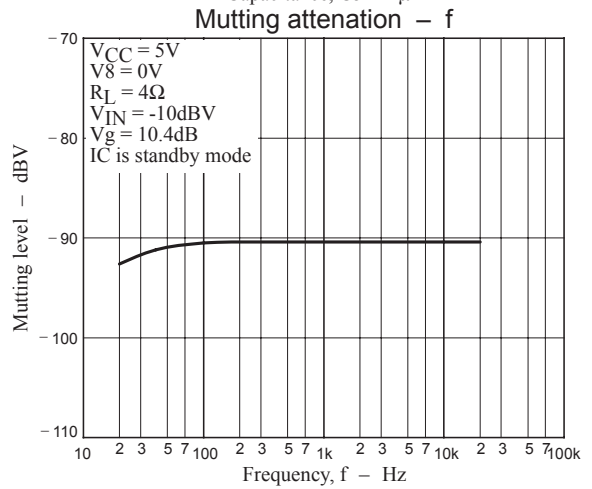
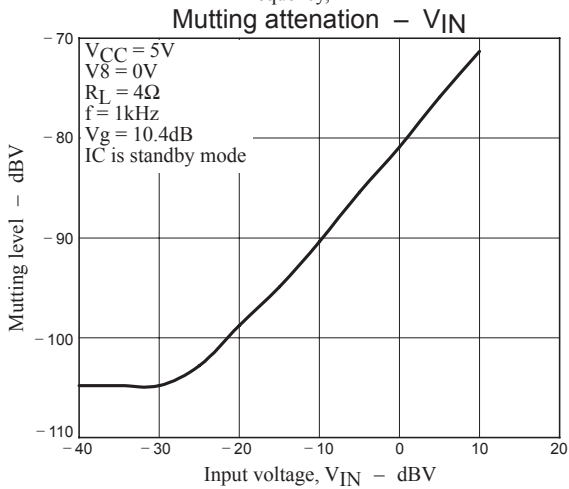
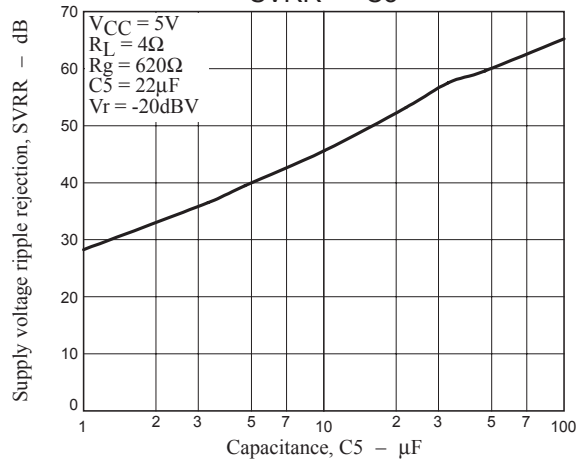
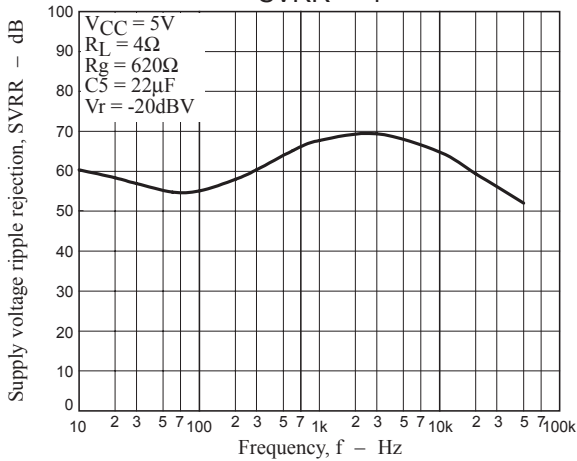
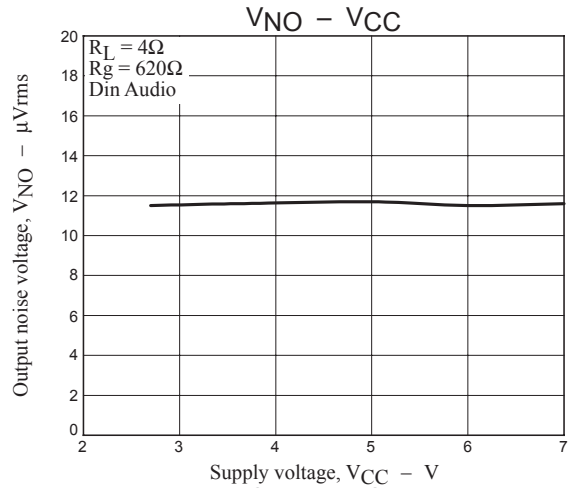
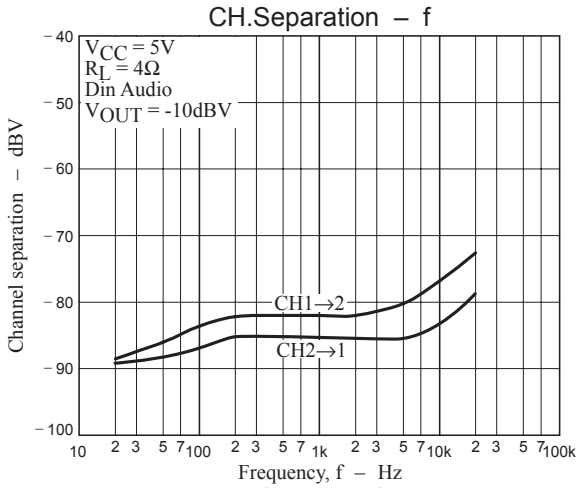

General characteristics BTL mode

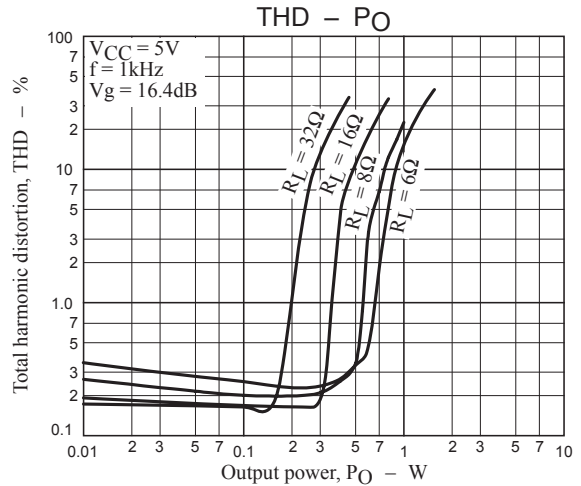
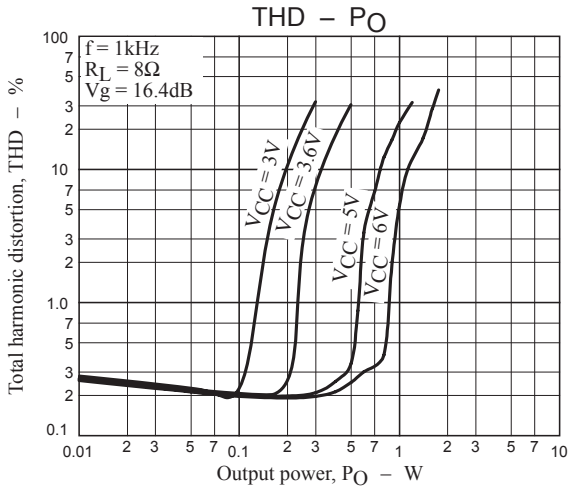

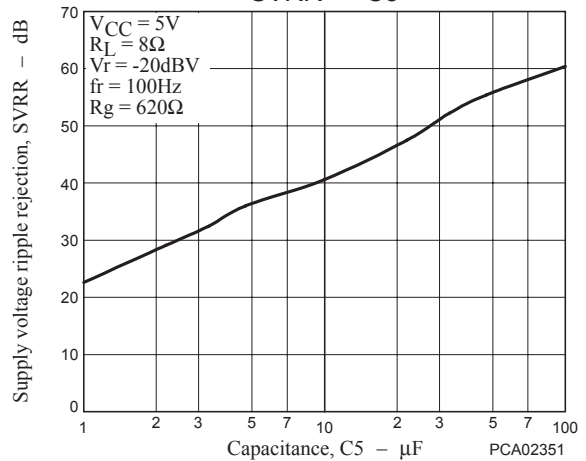
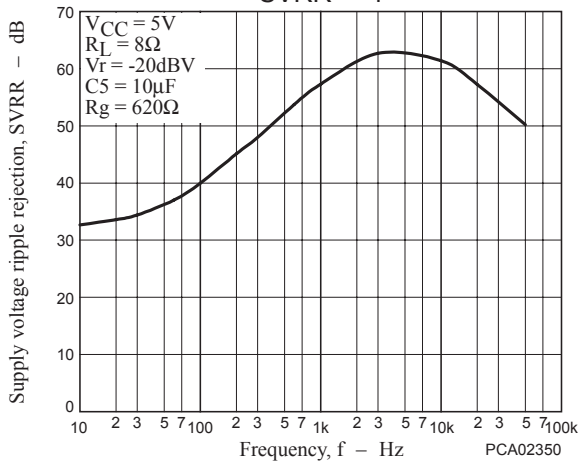
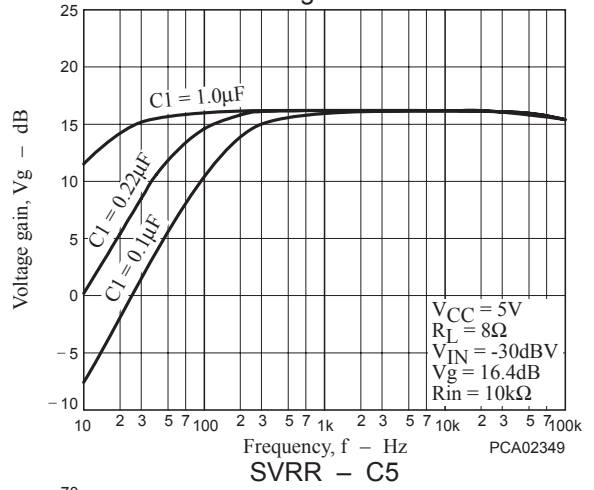
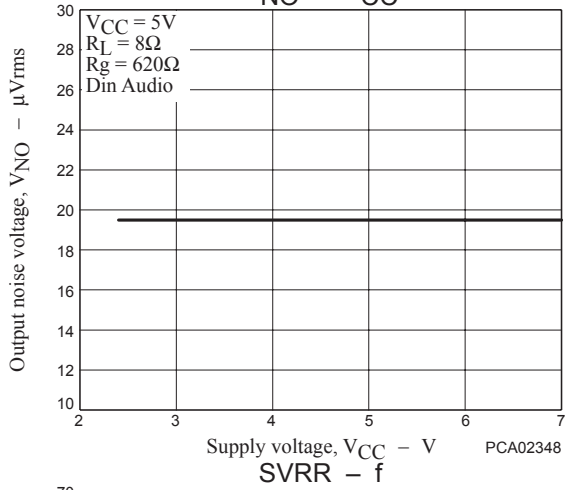
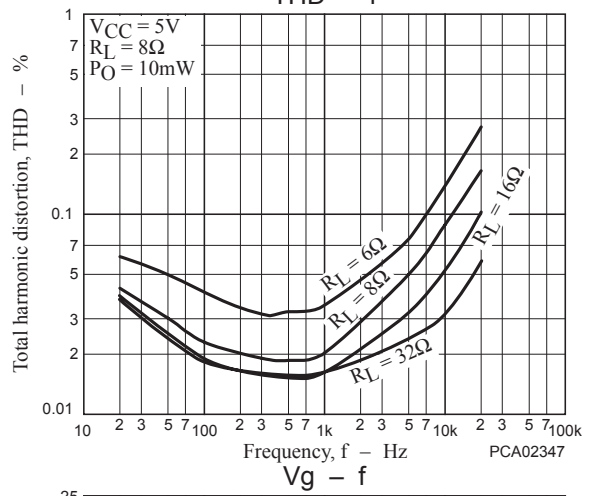
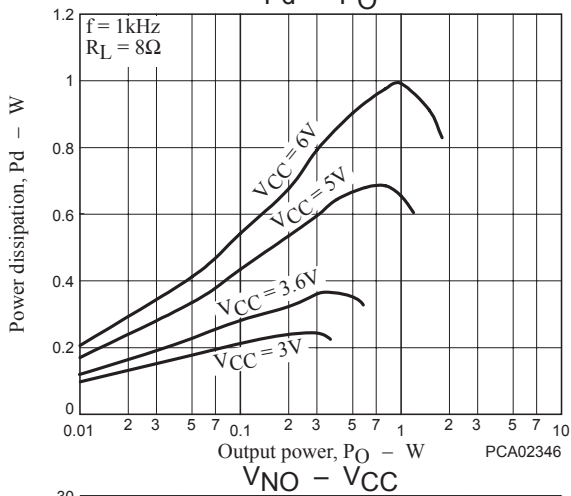
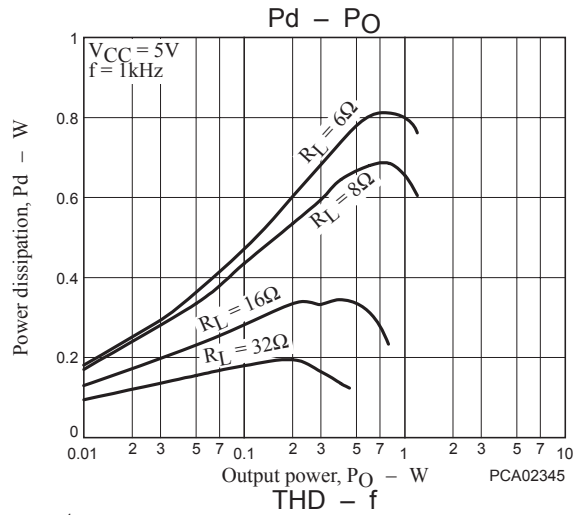
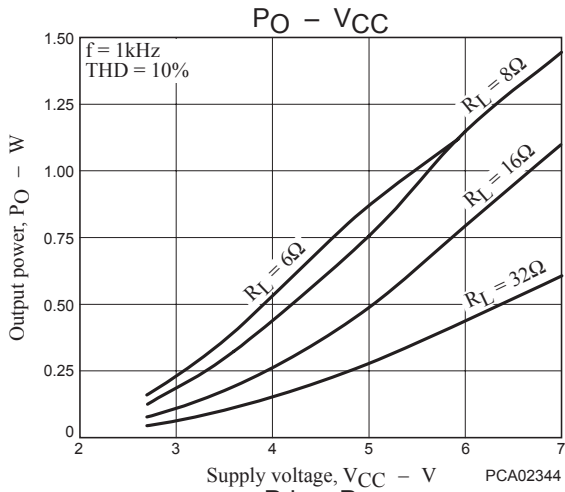

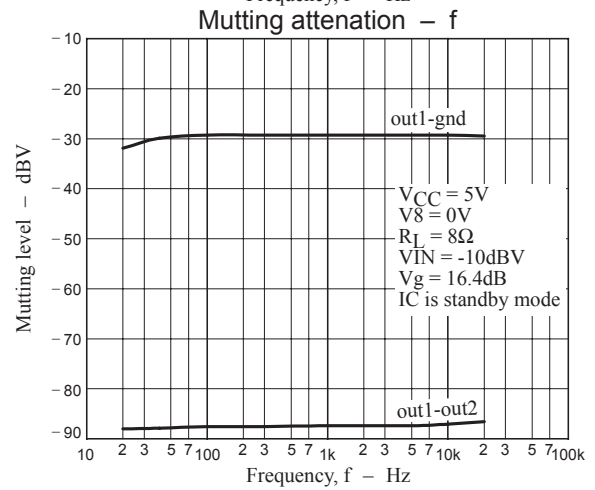
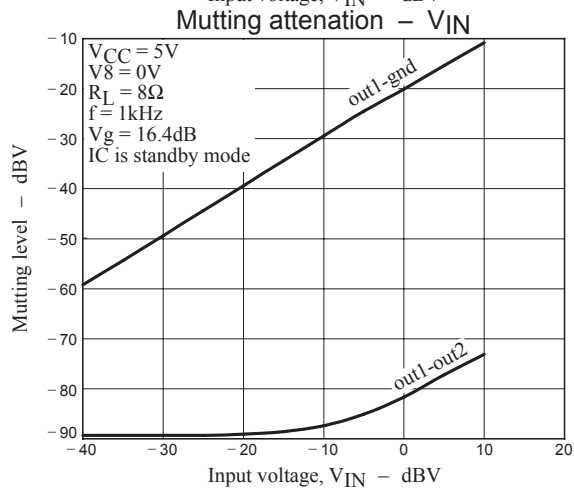
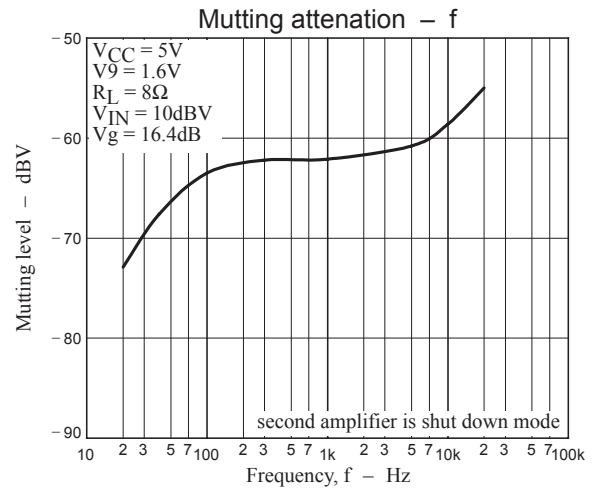
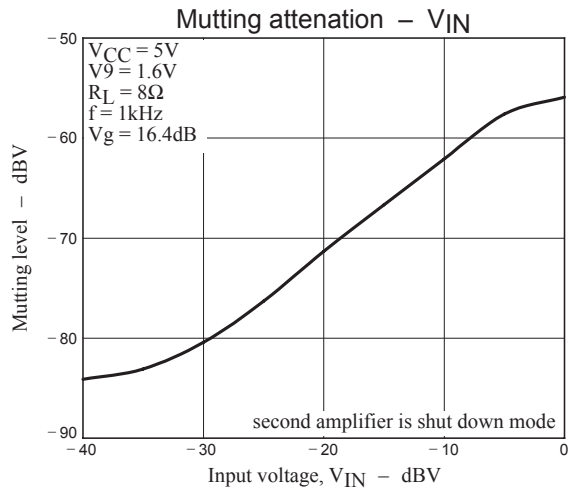

Temperature characteristics

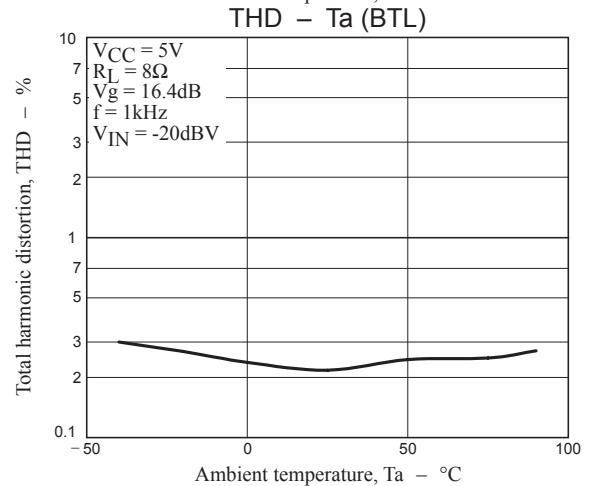
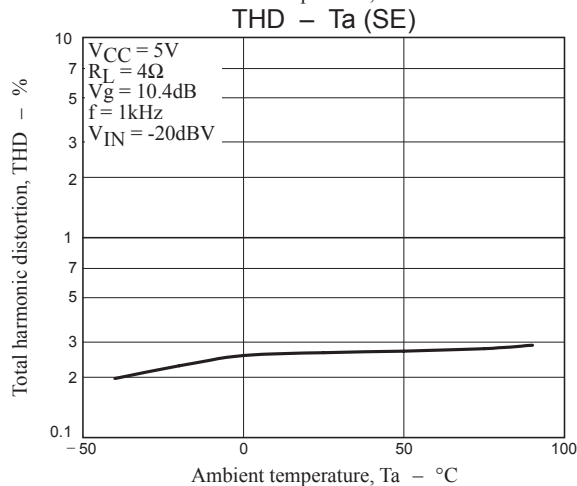
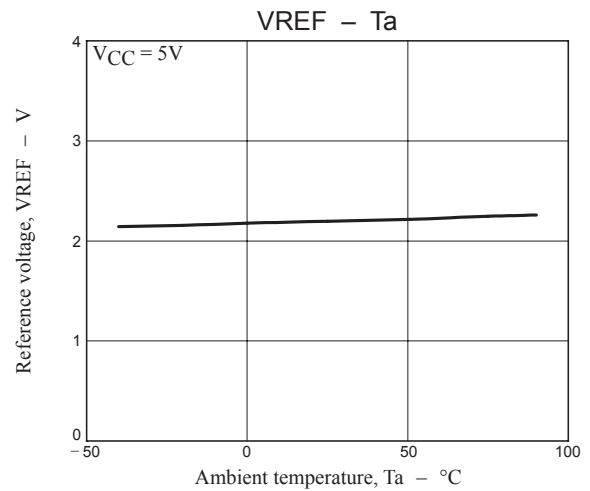
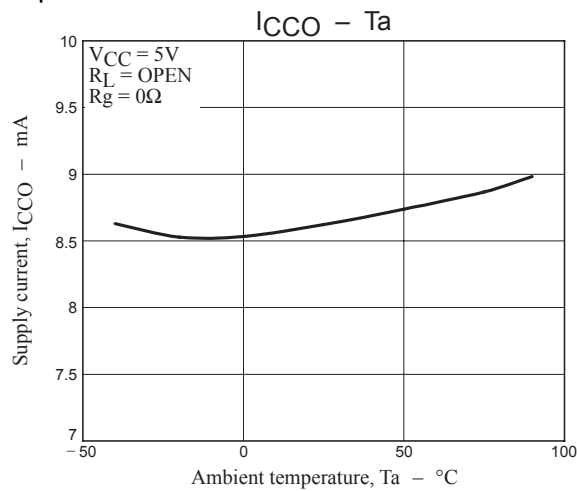

LA4814V

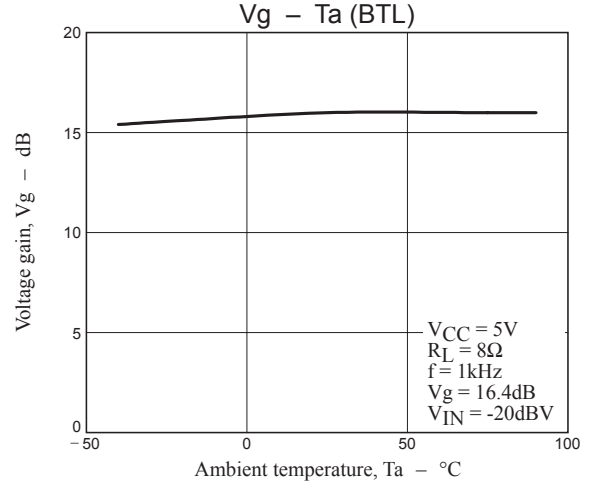
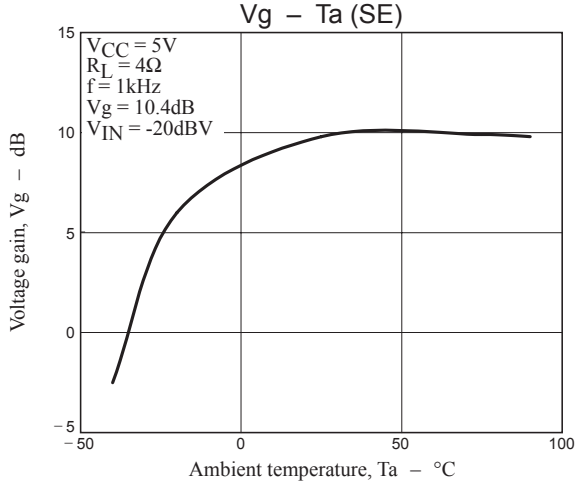
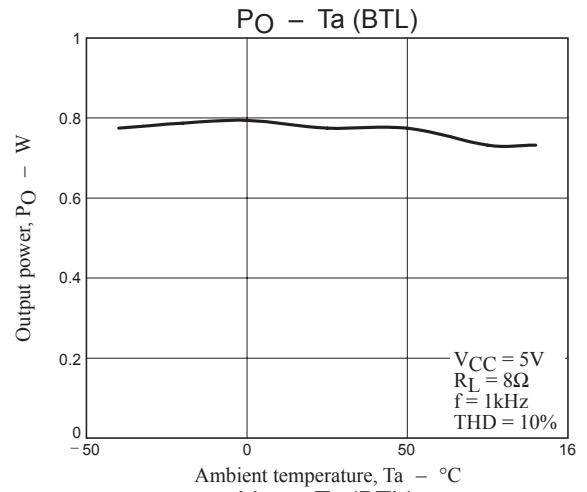
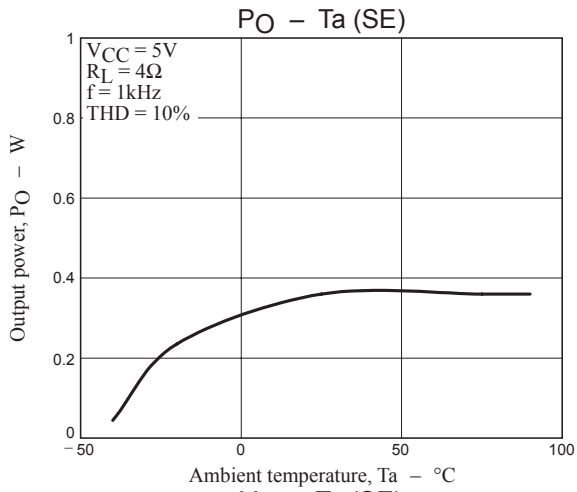

LA4814V

Pop noise

Single ended mode : Turn-on transient response characteristic

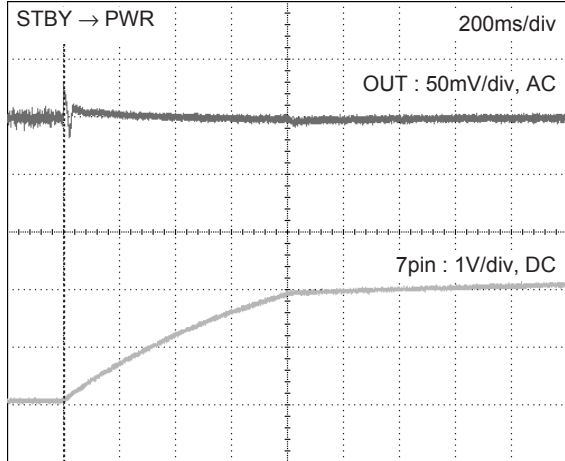

Single ended mode : Turn-off transient response characteristic

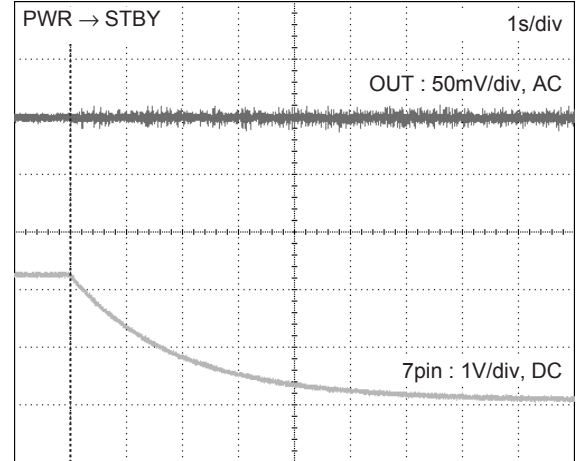

BTL mode: Turn-on transient response characteristic

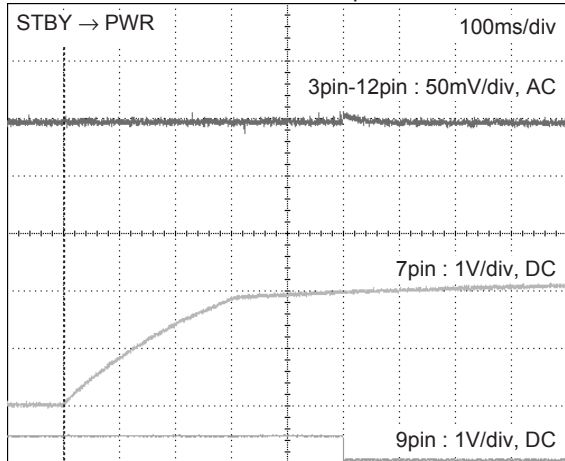

BTL mode: Turn-off transient response characteristic

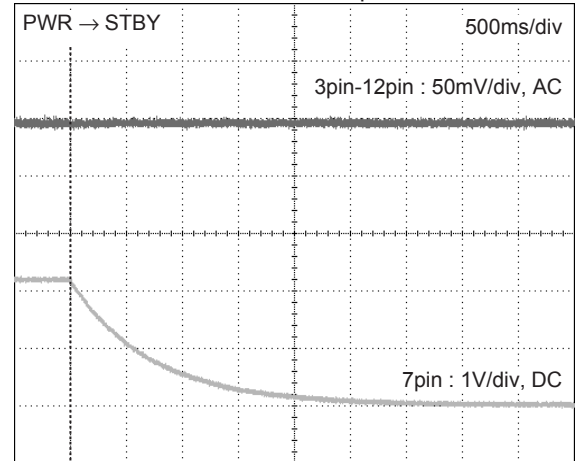

LA4814V

Evaluation board

1. Double-sided board

Size : 60mm×60mm×1.6mm

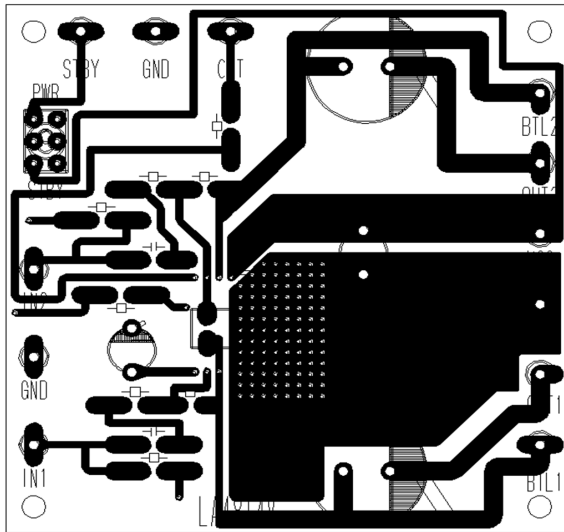

Top Layer

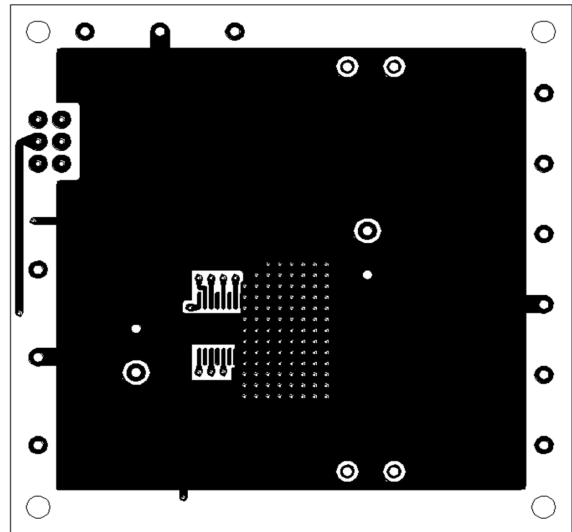

Bottom Layer

2. Single-sided board

Size : 70mm×80mm×1.6mm

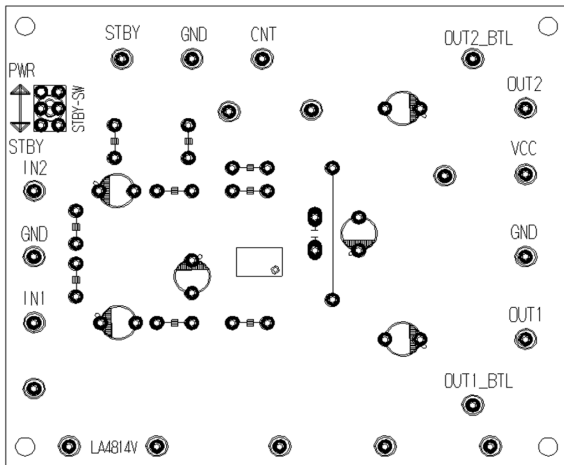

Top Layer

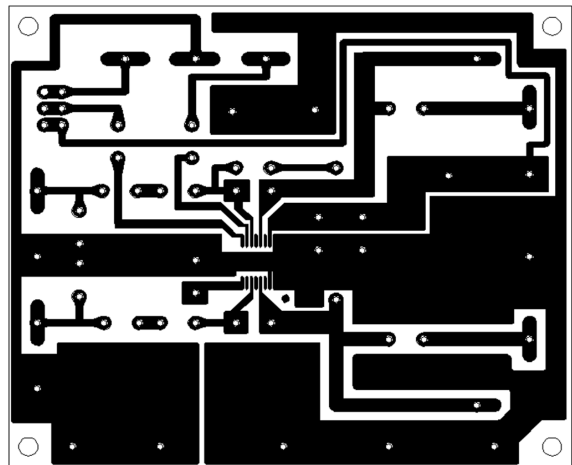

Bottom Layer

- SANYO Semiconductor Co.,Ltd. assumes no responsibility for equipment failures that result from using products at values that exceed, even momentarily, rated values (such as maximum ratings, operating condition ranges, or other parameters) listed in products specifications of any and all SANYO Semiconductor Co.,Ltd. products described or contained herein.
- SANYO Semiconductor Co.,Ltd. strives to supply high-quality high-reliability products, however, any and all semiconductor products fail or malfunction with some probability. It is possible that these probabilistic failures or malfunction could give rise to accidents or events that could endanger human lives, trouble that could give rise to smoke or fire, or accidents that could cause damage to other property. When designing equipment, adopt safety measures so that these kinds of accidents or events cannot occur. Such measures include but are not limited to protective circuits and error prevention circuits for safe design, redundant design, and structural design.
- In the event that any or all SANYO Semiconductor Co.,Ltd. products described or contained herein are controlled under any of applicable local export control laws and regulations, such products may require the export license from the authorities concerned in accordance with the above law.
- No part of this publication may be reproduced or transmitted in any form or by any means, electronic or mechanical, including photocopying and recording, or any information storage or retrieval system, or otherwise, without the prior written consent of SANYO Semiconductor Co.,Ltd.
- Any and all information described or contained herein are subject to change without notice due to product/technology improvement, etc. When designing equipment, refer to the "Delivery Specification" for the SANYO Semiconductor Co.,Ltd. product that you intend to use.
- Information (including circuit diagrams and circuit parameters) herein is for example only; it is not guaranteed for volume production.
- Upon using the technical information or products described herein, neither warranty nor license shall be granted with regard to intellectual property rights or any other rights of SANYO Semiconductor Co.,Ltd. or any third party. SANYO Semiconductor Co.,Ltd. shall not be liable for any claim or suits with regard to a third party's intellectual property rights which has resulted from the use of the technical information and products mentioned above.

This catalog provides information as of November, 2007. Specifications and information herein are subject to change without notice.