

# INTERNATIONAL RECTIFIER

## REPETITIVE AVALANCHE RATED AND $dv/dt$ RATED

### HEXFET<sup>®</sup> TRANSISTOR **IRFM9240**

**2N7237**

**JANS2N7237**

**JANTX2N7237**

**JANTXV2N7237**

[REF: MIL-S-19500/595]

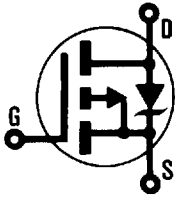

**P-CHANNEL**

### -200 Volt, 0.51 Ohm HEXFET

The HEXFET<sup>®</sup> technology is the key to International Rectifier's advanced line of power MOSFET transistors. The efficient geometry design achieves very low on-state resistance combined with high transconductance.

The HEXFET transistors also feature all of the well established advantages of MOSFETs such as voltage control, very fast switching, ease of paralleling and temperature stability of the electrical parameters.

They are well suited for applications such as switching power supplies and virtually any application where military and/or high reliability is required.

### Product Summary

Part Number	$BV_{DSS}$	$R_{DS(on)}$	$I_D$
IRFM9240	-200V	0.51 $\Omega$	-11A

### FEATURES:

- Repetitive Avalanche Rating
- Isolated and Hermetically Sealed
- Alternative to TO-3 Package
- Simple Drive Requirements
- Ease of Paralleling
- Ceramic Eyelets

### CASE STYLE AND DIMENSIONS

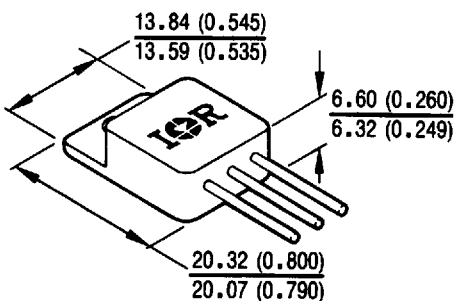

**CAUTION**

BERYLLIA WARNING PER MIL-S-19500  
SEE PAGE I-388

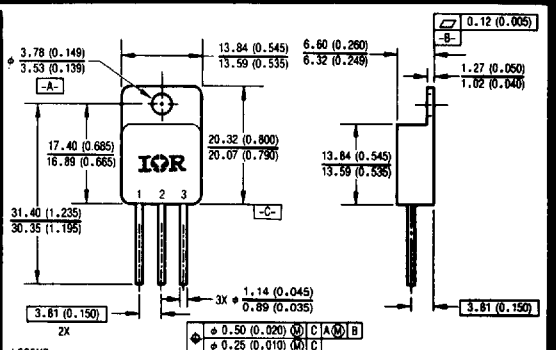

- LEGEND  
1 DRAIN  
2 SOURCE  
3 GATE

NOTES:

- 1 DIMENSIONING & TOLERANCING PER ANSI Y14.5M - 1982.
- 2 ALL DIMENSIONS ARE SHOWN IN MILLIMETERS AND (INCHES).

Conforms to JEDEC Outline TO-254AA\*  
Dimensions in Millimeters and (Inches)

\*For leadform configurations see page I-388, fig. 15

### Absolute Maximum Ratings

Parameter	IRFM9240, JANS, JANTXV, JANTX-, 2N7237	Units
$I_D$ @ $V_{GS} = 10V$ , $T_C = 25^\circ C$ Continuous Drain Current	-11	A
$I_D$ @ $V_{GS} = 10V$ , $T_C = 100^\circ C$ Continuous Drain Current	-7.0	
$I_{DM}$ Pulsed Drain Current ①	-44	
$P_D$ @ $T_C = 25^\circ C$ Max. Power Dissipation	125	W
Linear Derating Factor	1.0	W/K ⑤
$V_{GS}$ Gate-to-Source Voltage	$\pm 20$	V
$E_{AS}$ Single Pulse Avalanche Energy ②	500	mJ
$I_{AR}$ Avalanche Current ①	-11	A
$E_{AR}$ Repetitive Avalanche Energy ①	12.5	mJ
$dv/dt$ Peak Diode Recovery $dv/dt$ ③	-5.0	V/ns
$T_J$ Operating Junction Temperature	-55 to 150	°C
$T_{STG}$ Storage Temperature Range		
Lead Temperature	300 (0.063 in. (1.6 mm) from case for 10s)	
Weight	9.3 (typical)	g

### Electrical Characteristics @ $T_J = 25^\circ C$ (Unless Otherwise Specified)

Parameter	Min.	Typ.	Max.	Units	Test Conditions
$BV_{DSS}$ Drain-to-Source Breakdown Voltage	-200	—	—	V	$V_{GS} = 0V$ , $I_D = -1.0$ mA
$\Delta BV_{DSS}/\Delta T_J$ Temperature Coefficient of Breakdown Voltage	—	-0.20	—	V/°C	Reference to $25^\circ C$ , $I_D = -1.0$ mA
$R_{DS(on)}$ Static Drain-to-Source On-State Resistance	—	—	0.51	$\Omega$	$V_{GS} = -10V$ , $I_D = -7.0A$ ④
	—	—	0.52		$V_{GS} = -10V$ , $I_D = -11A$
$V_{GS(th)}$ Gate Threshold Voltage	-2.0	—	-4.0	V	$V_{DS} = V_{GS}$ , $I_D = -250$ $\mu A$
$g_{fs}$ Forward Transconductance	4.0	—	—	S (f)	$V_{DS} \geq -15V$ , $I_{DS} = -7.0A$ ④
$I_{DSS}$ Zero Gate Voltage Drain Current	—	—	-25	$\mu A$	$V_{DS} = 0.8 \times$ Max. Rating, $V_{GS} = 0V$
	—	—	-250		$V_{DS} = 0.8 \times$ Max. Rating
	—	—	—		$V_{GS} = 0V$ , $T_J = 125^\circ C$
$I_{GSS}$ Gate-to-Source Leakage Forward	—	—	-100	nA	$V_{GS} = -20V$
$I_{GSS}$ Gate-to-Source Leakage Reverse	—	—	100		$V_{GS} = 20V$
$Q_g$ Total Gate Charge	28	—	60	nC	$V_{GS} = -10V$ , $I_D = -11A$
$Q_{gs}$ Gate-to-Source Charge	3.0	—	15		$V_{DS} = 0.5 \times$ Max. Rating
$Q_{gd}$ Gate-to-Drain ("Miller") Charge	4.5	—	38		See Fig. 6 and 14
$t_{d(on)}$ Turn-On Delay Time	—	—	35		ns
$t_r$ Rise Time	—	—	85	See Fig. 11	
$t_{d(off)}$ Turn-Off Delay Time	—	—	85		
$t_f$ Fall Time	—	—	85		
$L_D$ Internal Drain Inductance	—	8.7	—		
$L_S$ Internal Source Inductance	—	8.7	—	Measured from the source lead, 6 mm (0.25 in.) from package to source bonding pad.	
$C_{iss}$ Input Capacitance	—	1200	—	pF	$V_{GS} = 0V$ , $V_{DS} = -25V$ $f = 1.0$ MHz See Fig. 5
$C_{oss}$ Output Capacitance	—	570	—		
$C_{rss}$ Reverse Transfer Capacitance	—	81	—		
$C_{DC}$ Drain-to-Case Capacitance	—	12	—		

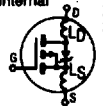



## Source-Drain Diode Ratings and Characteristics

Parameter	Min.	Typ.	Max.	Units	Test Conditions
$I_S$ Continuous Source Current (Body Diode)	—	—	-11	A	Modified MOSFET symbol showing the integral Reverse p-n junction rectifier. 
$I_{SM}$ Pulsed Source Current (Body Diode) ①	—	—	-44		
$V_{SD}$ Diode Forward Voltage	—	—	-4.6	V	$T_J = 25^\circ\text{C}$ , $I_S = -11\text{A}$ , $V_{GS} = 0\text{V}$ ④
$t_{rr}$ Reverse Recovery Time	—	—	440	ns	$T_J = 25^\circ\text{C}$ , $I_F = -11\text{A}$ , $di/dt \leq -100\text{A}/\mu\text{s}$ ④
$Q_{RR}$ Reverse Recovery Charge	—	—	7.2	$\mu\text{C}$	$V_{DD} \leq -50\text{V}$
$t_{on}$ Forward Turn-On Time	Intrinsic turn-on time is negligible. Turn-on speed is substantially controlled by $L_S + L_D$ .				

## Thermal Resistance

Parameter	Min.	Typ.	Max.	Units	Test Conditions
$R_{thJC}$ Junction-to-Case	—	—	1.0	K/W ⑤	Mounting surface flat, smooth, and greased Typical socket mount
$R_{thCS}$ Case-to-Sink	—	0.21	—		
$R_{thJA}$ Junction-to-Ambient	—	—	48		

① Repetitive Rating; Pulse width limited by maximum junction temperature (see figure 9) Refer to current HEXFET reliability report

② @  $V_{DD} = -50\text{V}$ , Starting  $T_J = 25^\circ\text{C}$ ,  
 $L \geq 6.2\text{ mH}$ ,  $R_G = 25\Omega$ ,  
Peak  $I_L = -11\text{A}$

③  $I_{SD} \leq -11\text{A}$ ,  $di/dt \leq -150\text{A}/\mu\text{s}$ ,  
 $V_{DD} \leq BV_{DSS}$ ,  $T_J \leq 150^\circ\text{C}$   
Suggested  $R_G = 9.1\Omega$

④ Pulse width  $\leq 300\ \mu\text{s}$ ; Duty Cycle  $\leq 2\%$

⑤  $K/W = ^\circ\text{C}/\text{W}$   
 $W/K = \text{W}/^\circ\text{C}$



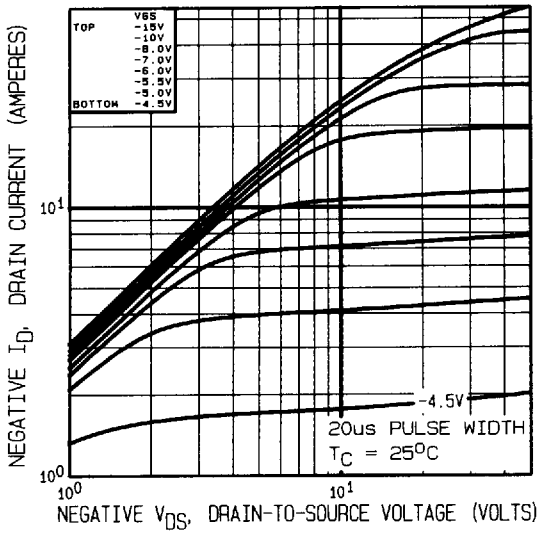

Fig. 1 — Typical Output Characteristics,  $T_C = 25^\circ\text{C}$

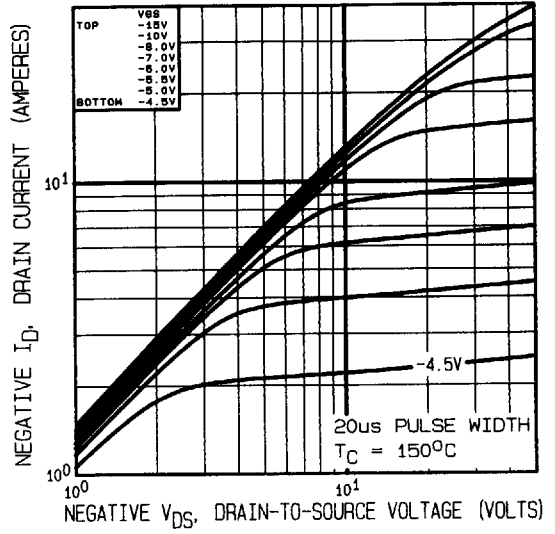

Fig. 2 — Typical Output Characteristics,  $T_C = 150^\circ\text{C}$

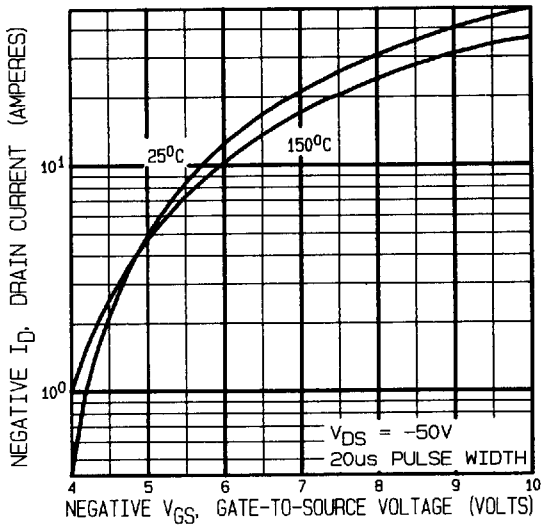

Fig. 3 — Typical Transfer Characteristics

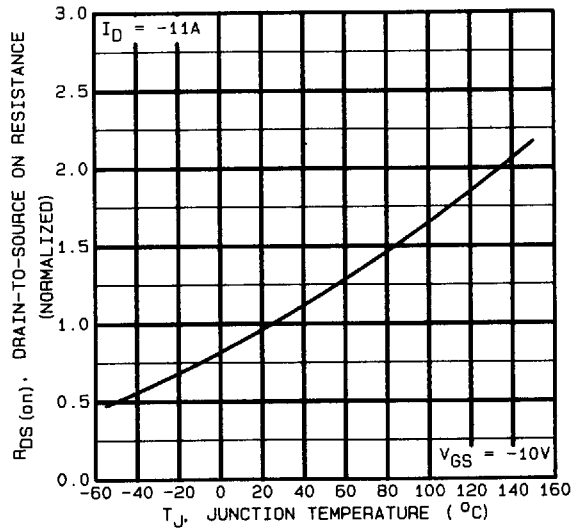

Fig. 4 — Normalized On-Resistance Vs. Temperature

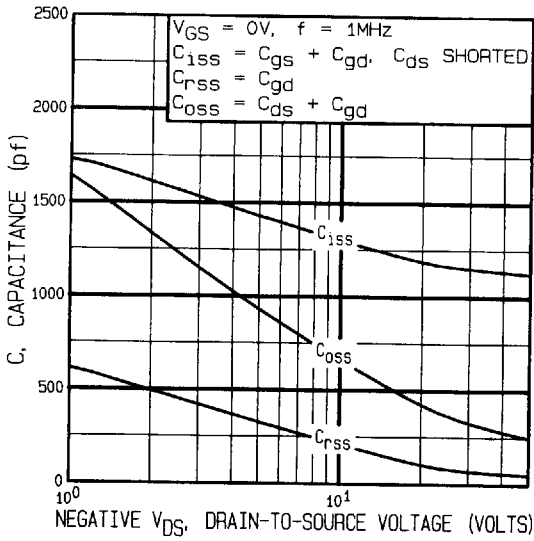

Fig. 5 — Typical Capacitance Vs. Drain-to-Source Voltage

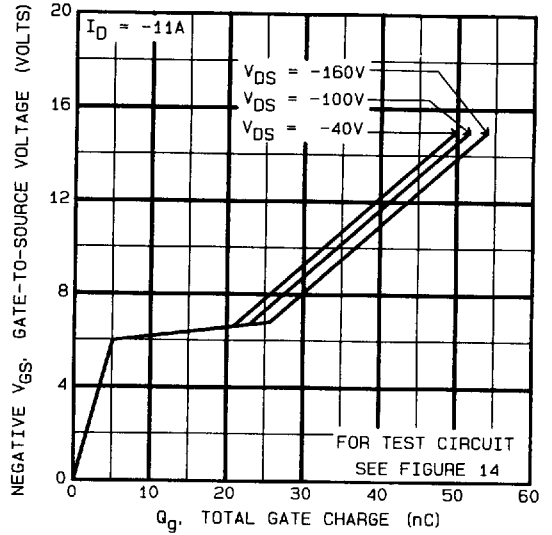

Fig. 6 — Typical Gate Charge Vs. Gate-to-Source Voltage

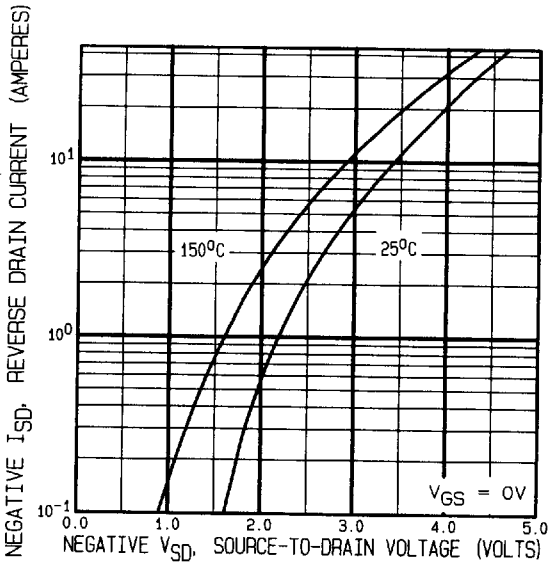

Fig. 7 — Typical Source-Drain Diode Forward Voltage

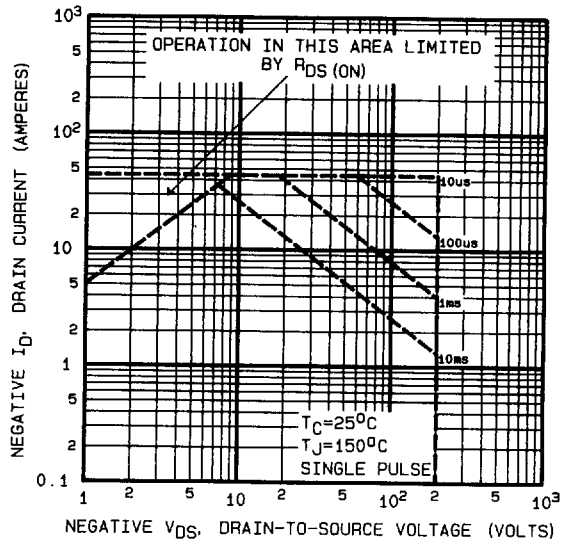

Fig. 8 — Maximum Safe Operating Area

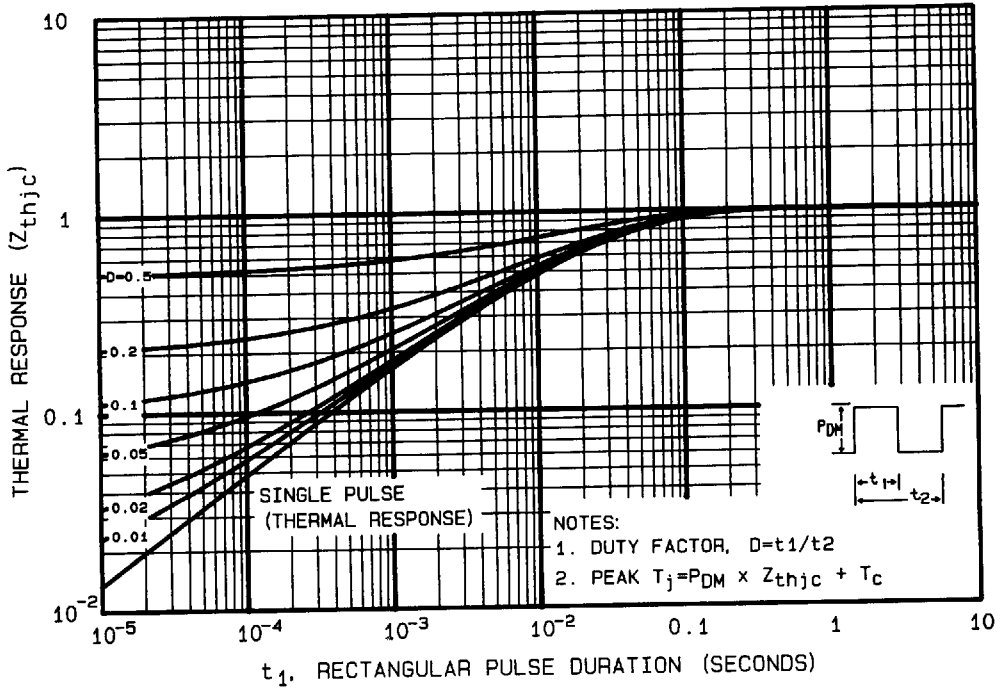

Fig. 9 — Maximum Effective Transient Thermal Impedance, Junction-to-Case Vs. Pulse Duration

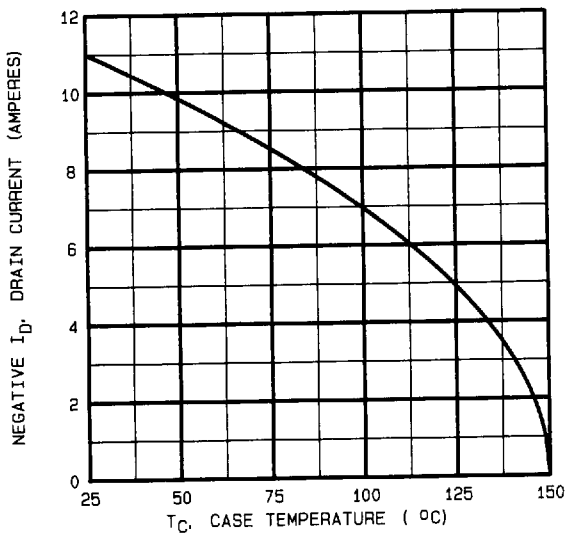

Fig. 10 — Maximum Drain Current Vs. Case Temperature

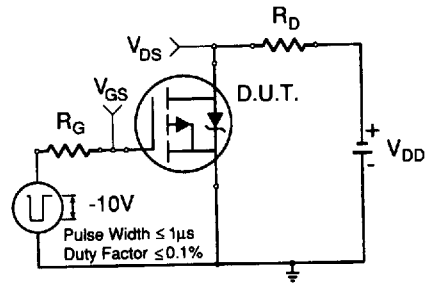

Fig. 11a — Switching Time Test Circuit

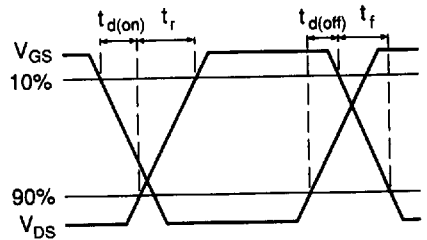

Fig. 11b — Switching Time Waveforms

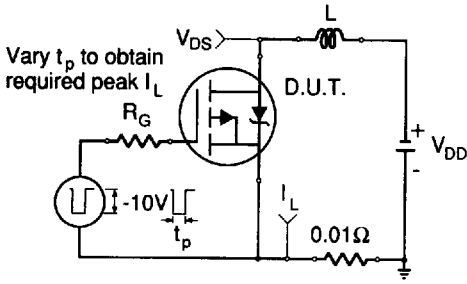

Fig. 12a — Unclamped Inductive Test Circuit

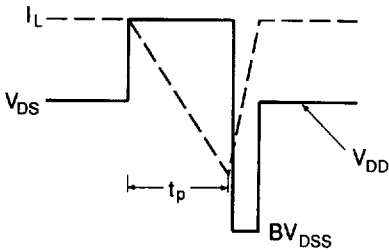

Fig. 12b — Unclamped Inductive Waveforms

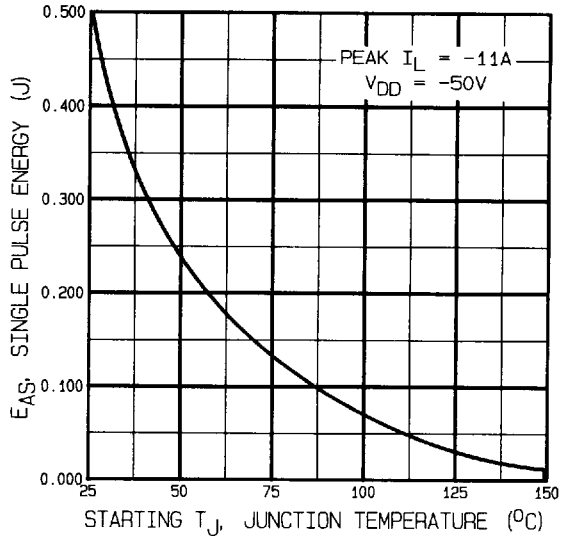

Fig. 12c — Maximum Avalanche Energy Vs. Starting Junction Temperature

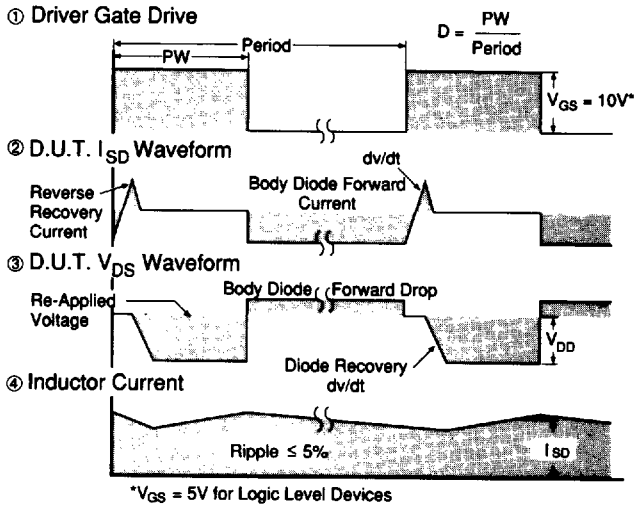
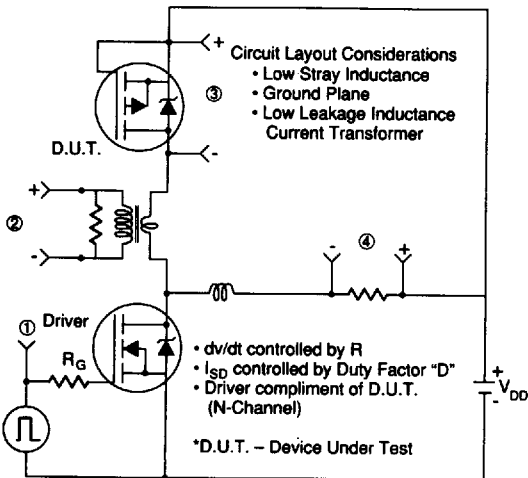

Fig. 13 — Peak Diode Recovery  $dv/dt$  Test Circuit

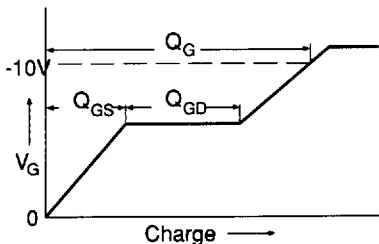

Fig. 14a — Basic Gate Charge Waveform

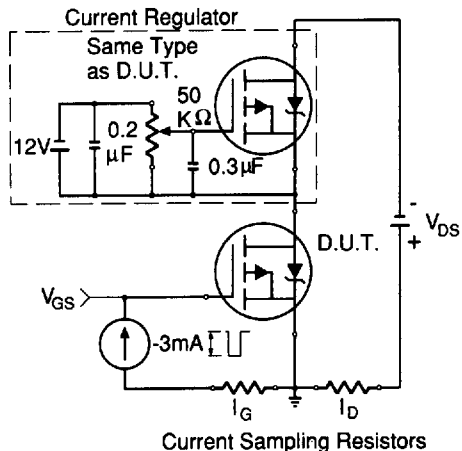

Fig. 14b — Gate Charge Test Circuit

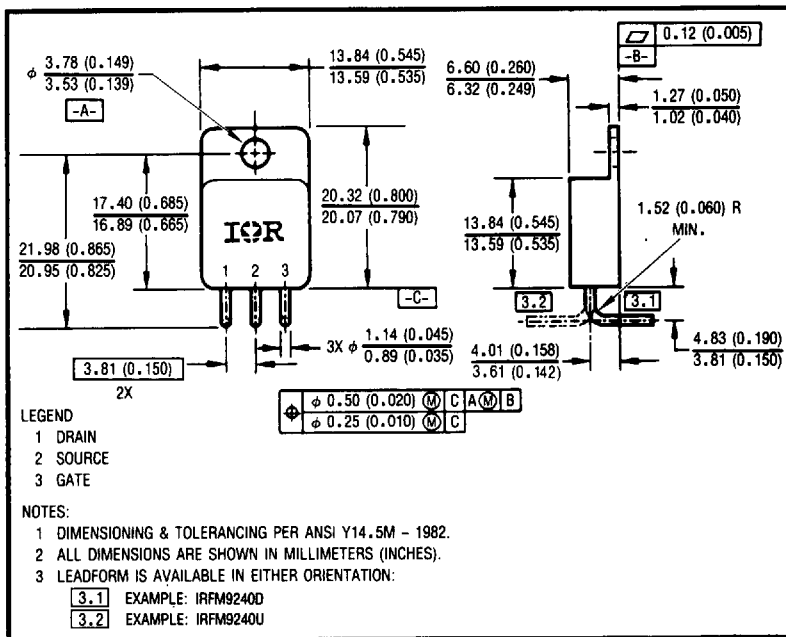

Fig. 15 — Optional Leadforms for Outline TO-254

**BERYLLIA WARNING PER MIL-S-19500**

Packages containing beryllia shall not be ground, sandblasted, machined, or have other operations performed on them which will produce beryllia or beryllium dust. Furthermore, beryllium oxide packages shall not be placed in acids that will produce fumes containing beryllium.