



CPH6001A — High-Frequency Low-Noise Amplifier Applications

NPN Epitaxial Planar Silicon Transistor

Features

- High gain : $|S_{21e}|^2 = 11\text{dB typ (f=1GHz)}$
- High cut-off frequency : $f_T = 6.7\text{GHz typ}$
- Small and slim 6-pin package
- Large allowable collector dissipation (800mW max)

Specifications

Absolute Maximum Ratings at $T_a = 25^\circ\text{C}$

Parameter	Symbol	Conditions	Ratings	Unit
Collector-to- Base Voltage	V_{CBO}		20	V
Collector-to-Emitter Voltage	V_{CEO}		12	V
Emitter-to-Base Voltage	V_{EBO}		2	V
Collector Current	I_C		100	mA
Collector Dissipation	P_C	When mounted on ceramic substrate (250mm ² ×0.8mm)	800	mW
Junction Temperature	T_j		150	°C
Storage Temperature	T_{stg}		-55 to +150	°C

Package Dimensions

unit : mm (typ)
7018A-002

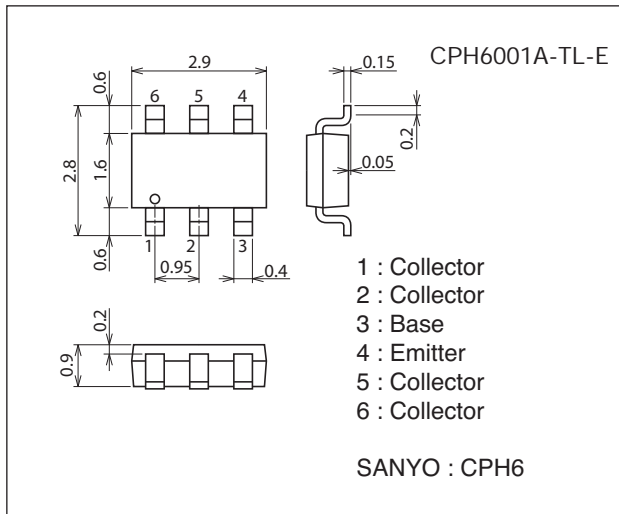

Product & Package Information

- Package : CPH6
- JEITA, JEDEC : SC-74, SOT-26, SOT-457
- Minimum Packing Quantity : 3,000 pcs./reel

Packing Type: TL

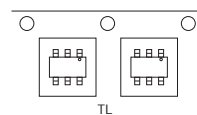

Marking

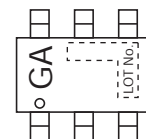

Electrical Connection

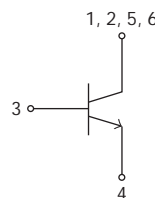

CPH6001A

Electrical Characteristics at Ta=25°C

Parameter	Symbol	Conditions	Ratings			Unit
			min	typ	max	
Collector Cutoff Current	ICBO	V _{CB} =10V, I _E =0A			1.0	μA
Emitter Cutoff Current	I _{EBO}	V _{EB} =1V, I _C =0A			10	μA
DC Current Gain	h _{FE1}	V _{CE} =5V, I _C =30mA	90		180	
	h _{FE2}	V _{CE} =5V, I _C =70mA	70			
Gain-Bandwidth Product	f _T	V _{CE} =5V, I _C =30mA	5	6.7		GHz
Output Capacitance	C _{ob}	V _{CB} =5V, f=1MHz		0.95	1.5	pF
Reverse Transfer Capacitance	C _{re}				0.6	pF
Forward Transfer Gain	S _{21e} ²	V _{CE} =5V, I _C =30mA, f=1GHz	9	11		dB
Noise Figure	NF	V _{CE} =5V, I _C =7mA, f=1GHz		1.1	2.0	dB

Ordering Information

Device	Package	Shipping	memo
CPH6001A-TL-E	CPH6	3,000pcs./reel	Pb Free

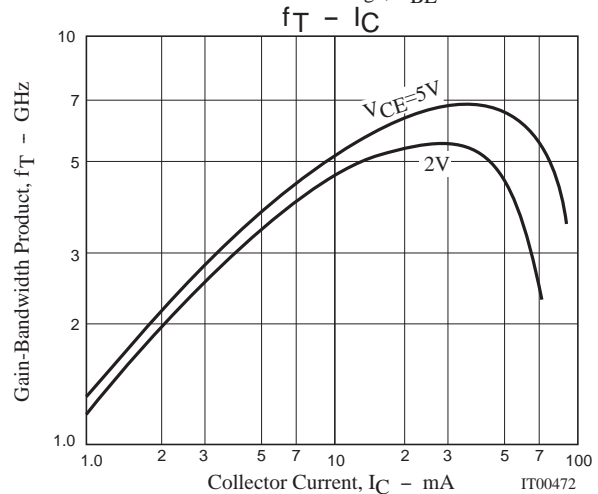
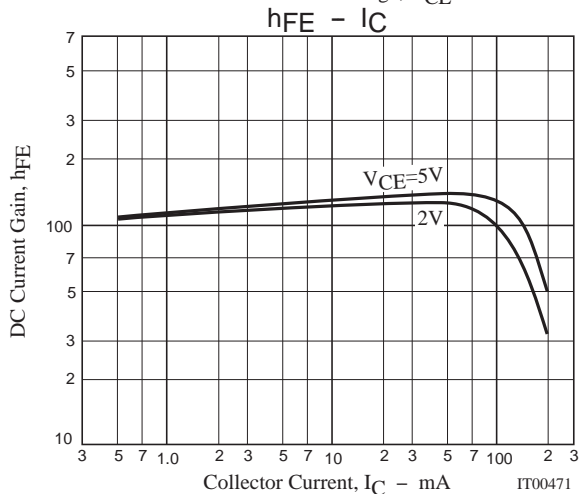
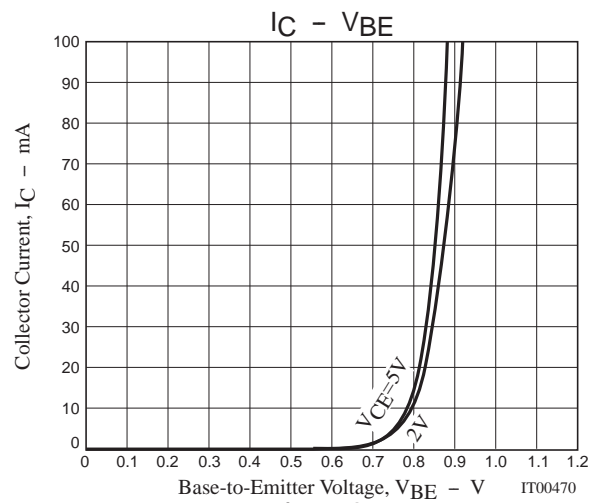
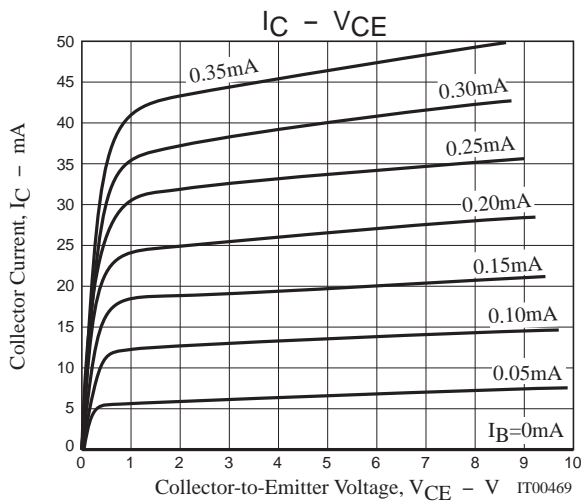

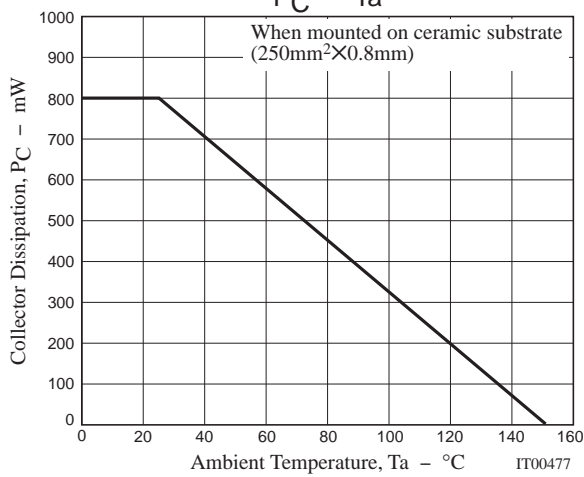
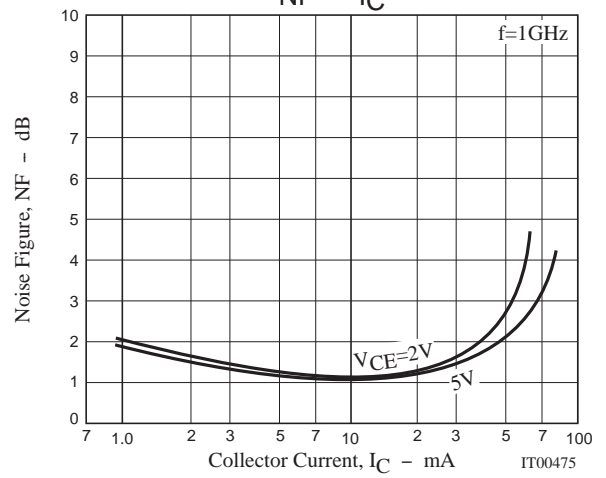
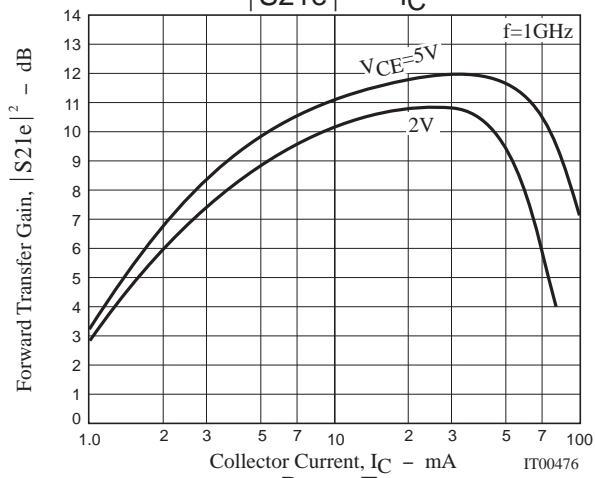
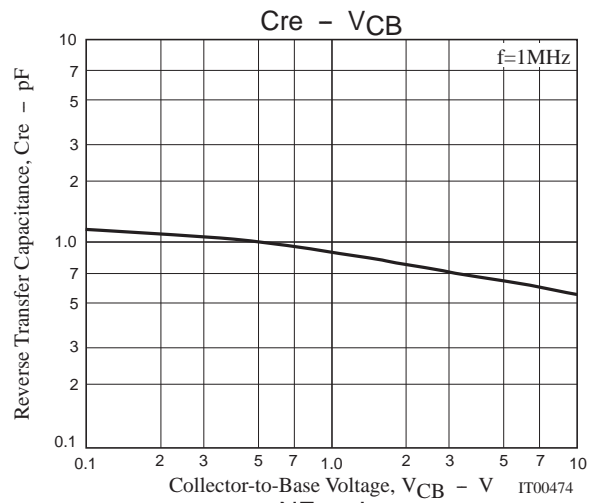
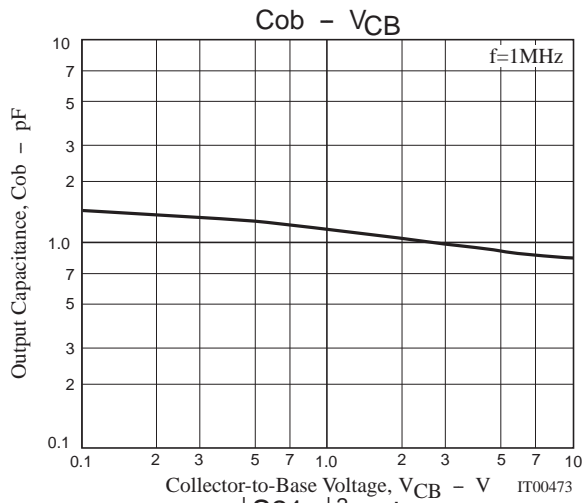

CPH6001A

S Parameters (Common emitter)

$V_{CE}=2V, I_C=5mA, Z_O=50\Omega$

Freq(MHz)	S11	$\angle S_{11}$	S21	$\angle S_{21}$	S12	$\angle S_{12}$	S22	$\angle S_{22}$
100	0.799	-48.2	12.990	147.1	0.044	65.4	0.871	-26.6
200	0.678	-83.5	9.939	125.1	0.069	51.4	0.687	-42.9
400	0.557	-124.8	6.138	101.0	0.090	42.3	0.476	-57.0
600	0.514	-147.5	4.326	87.6	0.103	41.5	0.390	-63.7
800	0.497	-161.9	3.345	77.6	0.115	43.4	0.353	-69.1
1000	0.488	-173.8	2.740	68.9	0.129	45.3	0.337	-74.6
1200	0.484	177.2	2.324	61.3	0.144	46.7	0.335	-79.9
1400	0.484	169.3	2.030	54.5	0.150	47.8	0.340	-85.1
1600	0.483	161.1	1.804	48.3	0.177	48.3	0.346	-90.6
1800	0.482	153.5	1.638	42.3	0.196	48.1	0.355	-96.6
2000	0.487	146.4	1.493	36.6	0.215	47.4	0.367	-102.1

$V_{CE}=2V, I_C=10mA, Z_O=50\Omega$

Freq(MHz)	S11	$\angle S_{11}$	S21	$\angle S_{21}$	S12	$\angle S_{12}$	S22	$\angle S_{22}$
100	0.683	-65.5	19.214	137.7	0.038	60.9	0.767	-38.0
200	0.550	-109.9	13.370	114.8	0.055	51.2	0.536	-55.8
400	0.440	-143.5	7.287	93.9	0.074	50.3	0.342	-69.5
600	0.443	-162.0	5.046	83.6	0.094	52.5	0.280	-75.8
800	0.457	-174.9	3.900	75.6	0.114	54.1	0.255	-81.6
1000	0.445	172.3	3.214	67.3	0.135	55.0	0.243	-87.7
1200	0.427	166.4	2.681	60.6	0.156	54.5	0.245	-92.6
1400	0.418	162.9	2.309	54.1	0.177	53.7	0.251	-97.6
1600	0.439	160.3	1.987	49.2	0.199	52.5	0.258	-102.6
1800	0.486	149.1	1.850	46.2	0.221	50.6	0.269	-107.7
2000	0.468	137.2	1.745	40.2	0.241	48.2	0.280	-112.9

$V_{CE}=2V, I_C=20mA, Z_O=50\Omega$

Freq(MHz)	S11	$\angle S_{11}$	S21	$\angle S_{21}$	S12	$\angle S_{12}$	S22	$\angle S_{22}$
100	0.540	-87.3	24.533	127.8	0.032	58.3	0.646	-49.3
200	0.469	-125.4	14.920	107.9	0.045	55.2	0.411	-67.4
400	0.437	-157.2	8.009	91.0	0.067	59.1	0.256	-81.3
600	0.430	-171.6	5.453	81.5	0.091	61.2	0.210	-89.3
800	0.428	178.4	4.148	74.0	0.116	61.3	0.197	-95.4
1000	0.427	170.3	3.373	67.4	0.140	60.3	0.196	-100.5
1200	0.424	163.2	2.840	61.0	0.164	58.5	0.201	-105.2
1400	0.424	156.9	2.484	55.3	0.189	56.7	0.208	-109.8
1600	0.423	150.0	2.201	50.1	0.212	54.6	0.218	-114.2
1800	0.420	144.2	1.999	44.8	0.236	52.0	0.228	-119.0
2000	0.422	136.2	1.825	39.5	0.257	49.0	0.238	-123.8

$V_{CE}=2V, I_C=30mA, Z_O=50\Omega$

Freq(MHz)	S11	$\angle S_{11}$	S21	$\angle S_{21}$	S12	$\angle S_{12}$	S22	$\angle S_{22}$
100	0.487	-101.2	26.240	123.1	0.029	58.4	0.579	-54.7
200	0.446	-136.8	15.309	104.6	0.041	58.0	0.356	-72.3
400	0.435	-163.5	8.071	89.3	0.065	62.9	0.223	-86.1
600	0.437	-176.4	5.488	80.4	0.090	64.2	0.186	-94.2
800	0.433	174.9	4.181	73.3	0.117	63.7	0.178	-100.3
1000	0.435	166.8	3.388	66.7	0.142	62.3	0.180	-105.7
1200	0.433	160.8	2.855	60.5	0.168	60.1	0.187	-110.1
1400	0.427	154.6	2.491	54.8	0.192	57.9	0.195	-114.4
1600	0.432	147.9	2.211	49.7	0.217	55.4	0.205	-118.8
1800	0.428	141.8	2.002	44.3	0.241	52.7	0.217	-123.3
2000	0.430	134.8	1.831	39.4	0.261	49.4	0.227	-127.9

CPH6001A

S Parameters (Common emitter)

$V_{CE}=5V, I_C=5mA, Z_O=50\Omega$

Freq(MHz)	S11	$\angle S_{11}$	S21	$\angle S_{21}$	S12	$\angle S_{12}$	S22	$\angle S_{22}$
100	0.822	-42.5	13.211	150.0	0.035	68.2	0.901	-20.9
200	0.684	-77.8	10.639	128.5	0.056	54.8	0.743	-34.0
400	0.516	-116.3	6.681	103.3	0.076	45.3	0.548	-44.9
600	0.481	-140.7	4.776	89.6	0.087	44.9	0.467	-49.9
800	0.477	-157.6	3.714	80.0	0.098	46.3	0.433	-54.2
1000	0.454	-172.9	3.055	71.0	0.110	48.5	0.419	-58.8
1200	0.435	179.1	2.572	63.0	0.124	50.1	0.416	-64.0
1400	0.431	173.9	2.213	56.2	0.138	51.7	0.419	-68.9
1600	0.449	169.6	1.922	50.7	0.154	52.8	0.424	-74.4
1800	0.495	157.8	1.789	46.3	0.171	52.8	0.431	-80.3
2000	0.482	145.3	1.669	39.6	0.188	52.4	0.440	-85.7

$V_{CE}=5V, I_C=10mA, Z_O=50\Omega$

Freq(MHz)	S11	$\angle S_{11}$	S21	$\angle S_{21}$	S12	$\angle S_{12}$	S22	$\angle S_{22}$
100	0.690	-57.0	20.017	141.0	0.031	64.0	0.813	-29.6
200	0.552	-93.8	14.091	118.9	0.046	54.8	0.599	-43.3
400	0.447	-133.6	8.190	97.6	0.064	52.8	0.419	-51.2
600	0.413	-154.2	5.664	86.0	0.080	55.0	0.355	-54.8
800	0.402	-167.0	4.314	77.6	0.098	56.9	0.329	-58.9
1000	0.399	-177.7	3.519	70.1	0.116	57.8	0.320	-63.5
1200	0.395	173.3	2.985	63.3	0.135	57.5	0.322	-68.5
1400	0.390	165.6	2.590	57.2	0.154	57.1	0.325	-73.5
1600	0.396	158.1	2.293	51.4	0.173	56.1	0.332	-78.8
1800	0.398	150.8	2.069	45.7	0.193	54.6	0.341	-84.4
2000	0.396	143.4	1.881	40.4	0.211	52.8	0.350	-90.0

$V_{CE}=5V, I_C=30mA, Z_O=50\Omega$

Freq(MHz)	S11	$\angle S_{11}$	S21	$\angle S_{21}$	S12	$\angle S_{12}$	S22	$\angle S_{22}$
100	0.481	-85.7	28.955	127.1	0.024	61.8	0.649	-41.0
200	0.403	-123.6	17.443	107.7	0.035	60.6	0.427	-51.3
400	0.370	-155.2	9.326	91.5	0.056	64.6	0.292	-54.9
600	0.363	-170.7	6.348	82.3	0.078	66.1	0.256	-57.9
800	0.359	179.9	4.826	75.3	0.100	65.9	0.245	-62.2
1000	0.360	171.2	3.907	68.5	0.123	64.8	0.244	-67.4
1200	0.360	164.4	3.288	62.7	0.145	63.1	0.249	-72.7
1400	0.356	157.3	2.871	57.0	0.167	61.2	0.256	-78.0
1600	0.362	151.2	2.541	51.8	0.188	59.0	0.265	-83.6
1800	0.361	143.6	2.290	46.5	0.210	56.5	0.274	-89.4
2000	0.363	137.2	2.076	41.4	0.229	53.6	0.284	-95.1

$V_{CE}=5V, I_C=50mA, Z_O=50\Omega$

Freq(MHz)	S11	$\angle S_{11}$	S21	$\angle S_{21}$	S12	$\angle S_{12}$	S22	$\angle S_{22}$
100	0.426	-101.6	29.939	122.4	0.021	62.6	0.587	-42.4
200	0.389	-137.3	17.324	104.3	0.032	63.2	0.385	-49.1
400	0.379	-163.4	9.137	89.5	0.053	67.9	0.277	-50.5
600	0.378	-176.3	6.195	80.8	0.076	68.9	0.252	-53.4
800	0.375	175.0	4.700	74.0	0.098	68.3	0.245	-58.2
1000	0.380	167.8	3.799	67.9	0.121	66.8	0.248	-64.0
1200	0.379	161.2	3.196	61.8	0.143	64.9	0.255	-69.8
1400	0.378	154.9	2.787	56.1	0.165	62.8	0.262	-75.4
1600	0.382	148.6	2.469	50.9	0.187	60.5	0.271	-81.4
1800	0.382	142.5	2.227	45.8	0.209	57.8	0.281	-87.6
2000	0.385	135.6	2.027	40.7	0.228	55.0	0.291	-93.3

CPH6001A

Embossed Taping Specification

CPH6001A-TL-E

1. Packing Format

Package Name	Carrier Tape Type	Maximum Number of devices contained (pcs)			Packing format	
		Reel	Inner box	Outer box	Inner BOX (C-1)	Outer BOX (A-7)
CPH6	CPH6	3,000	15,000	90,000	5 reels contained Dimensions:mm (external) 183×72×185	6 inner boxes contained Dimensions:mm (external) 440×195×210

Reel label, Inner box label
(unit:mm)

Outer box label

It is a label at the time of factory shipments.
The form of a label may change in physical distribution process.

Packing method

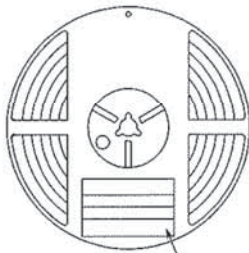

Reel label

Type No.
LOT No.
Quantity
Origin

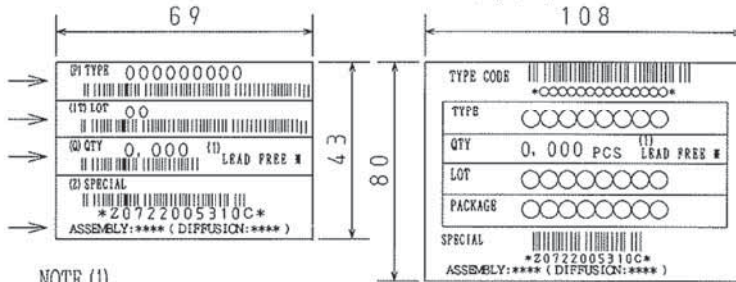

NOTE (1)

The LEAD FREE * description shows that the surface treatment of the terminal is lead free.

Label	JEITA Phase
LEAD FREE 3	JEITA Phase 3A
LEAD FREE 4	JEITA Phase 3

2. Taping configuration

2-1. Carrier tape size (unit:mm)

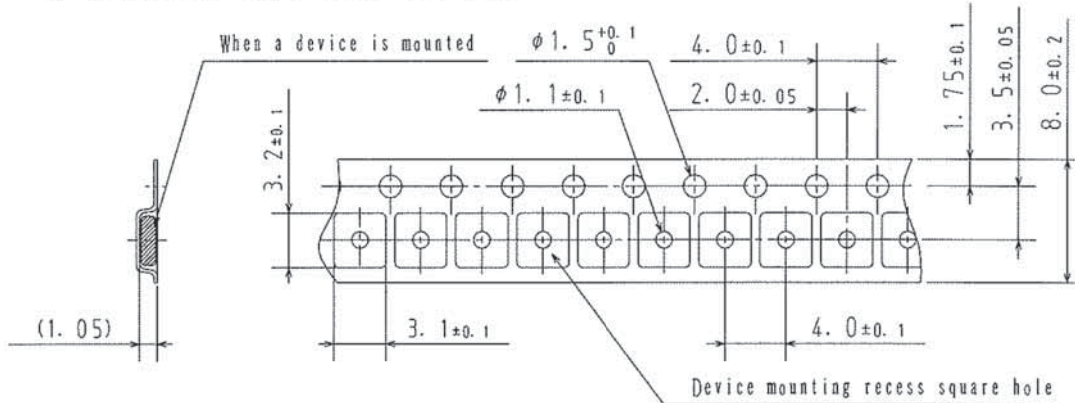

2-2. Device placement direction

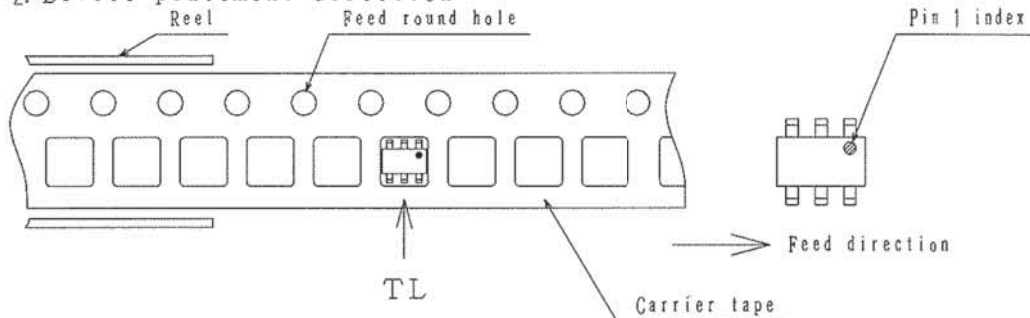

Those with pin 1 index on the feed hole side.....TL

CPH6001A

Outline Drawing CPH6001A-TL-E

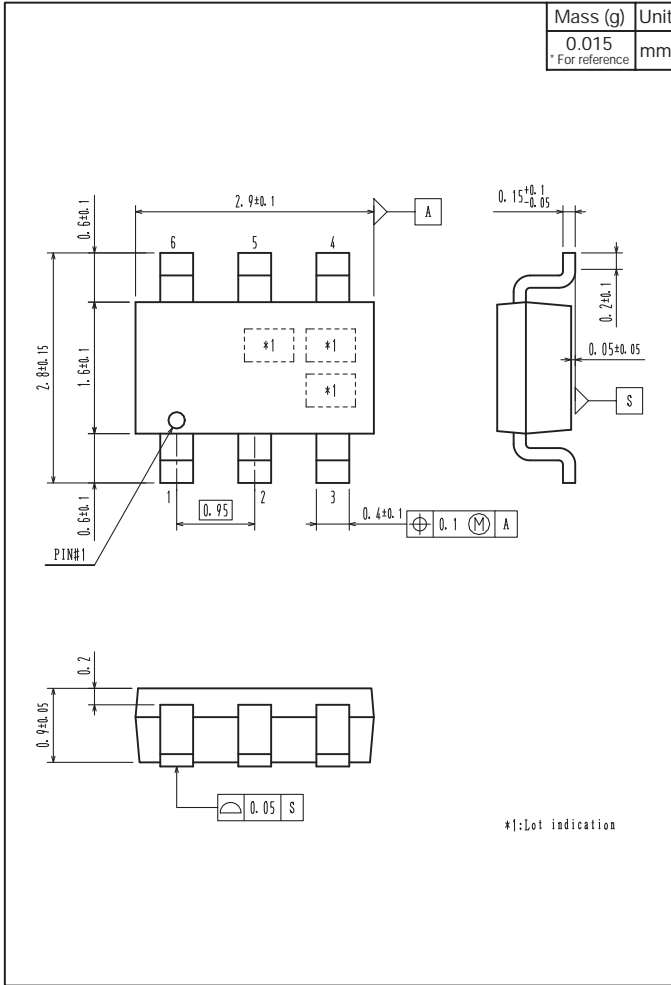

Land Pattern Example

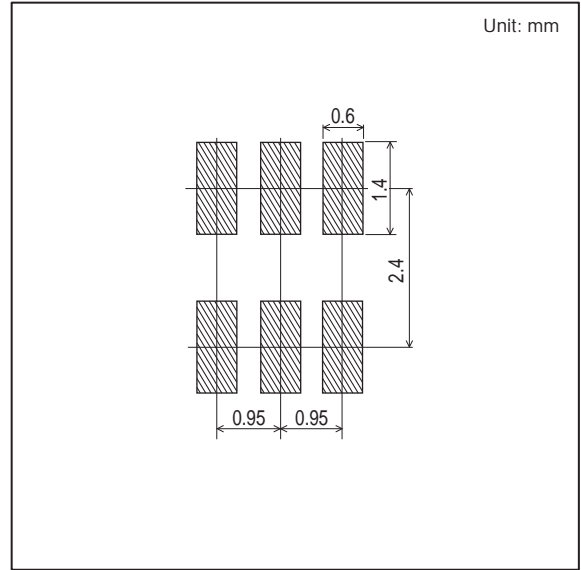

- Any and all SANYO Semiconductor Co.,Ltd. products described or contained herein are, with regard to "standard application", intended for the use as general electronics equipment. The products mentioned herein shall not be intended for use for any "special application" (medical equipment whose purpose is to sustain life, aerospace instrument, nuclear control device, burning appliances, transportation machine, traffic signal system, safety equipment etc.) that shall require extremely high level of reliability and can directly threaten human lives in case of failure or malfunction of the product or may cause harm to human bodies, nor shall they grant any guarantee thereof. If you should intend to use our products for new introduction or other application different from current conditions on the usage of automotive device, communication device, office equipment, industrial equipment etc. , please consult with us about usage condition (temperature, operation time etc.) prior to the intended use. If there is no consultation or inquiry before the intended use, our customer shall be solely responsible for the use.
- Specifications of any and all SANYO Semiconductor Co.,Ltd. products described or contained herein stipulate the performance, characteristics, and functions of the described products in the independent state, and are not guarantees of the performance, characteristics, and functions of the described products as mounted in the customer's products or equipment. To verify symptoms and states that cannot be evaluated in an independent device, the customer should always evaluate and test devices mounted in the customer's products or equipment.
- SANYO Semiconductor Co.,Ltd. assumes no responsibility for equipment failures that result from using products at values that exceed, even momentarily, rated values (such as maximum ratings, operating condition ranges, or other parameters) listed in products specifications of any and all SANYO Semiconductor Co.,Ltd. products described or contained herein.
- Regarding monolithic semiconductors, if you should intend to use this IC continuously under high temperature, high current, high voltage, or drastic temperature change, even if it is used within the range of absolute maximum ratings or operating conditions, there is a possibility of decrease reliability. Please contact us for a confirmation.
- SANYO Semiconductor Co.,Ltd. strives to supply high-quality high-reliability products, however, any and all semiconductor products fail or malfunction with some probability. It is possible that these probabilistic failures or malfunction could give rise to accidents or events that could endanger human lives, trouble that could give rise to smoke or fire, or accidents that could cause damage to other property. When designing equipment, adopt safety measures so that these kinds of accidents or events cannot occur. Such measures include but are not limited to protective circuits and error prevention circuits for safe design, redundant design, and structural design.
- In the event that any or all SANYO Semiconductor Co.,Ltd. products described or contained herein are controlled under any of applicable local export control laws and regulations, such products may require the export license from the authorities concerned in accordance with the above law.
- No part of this publication may be reproduced or transmitted in any form or by any means, electronic or mechanical, including photocopying and recording, or any information storage or retrieval system, or otherwise, without the prior written consent of SANYO Semiconductor Co.,Ltd.
- Any and all information described or contained herein are subject to change without notice due to product/technology improvement, etc. When designing equipment, refer to the "Delivery Specification" for the SANYO Semiconductor Co.,Ltd. product that you intend to use.
- Upon using the technical information or products described herein, neither warranty nor license shall be granted with regard to intellectual property rights or any other rights of SANYO Semiconductor Co.,Ltd. or any third party. SANYO Semiconductor Co.,Ltd. shall not be liable for any claim or suits with regard to a third party's intellectual property rights which has resulted from the use of the technical information and products mentioned above.

This catalog provides information as of July, 2012. Specifications and information herein are subject to change without notice.