

# Dual Single-Phase PWM Controller for CPU and GPU Core Power Supply

## General Description

The RT8167B is a dual single-phase PWM controller with integrated MOSFET drivers, compliant with Intel IMVP7 Pulse Width Modulation Specification to support both CPU core and GPU core power. This part adopts G-NAVP™ (Green-Native AVP), which is a Richtek proprietary topology derived from finite DC gain compensator in constant on-time control mode. G-NAVP™ makes this part an easy setting PWM controller to meet all Intel AVP (Active Voltage Positioning) mobile CPU/GPU requirements. The RT8167B uses SVID interface to control an 8-bit DAC for output voltage programming. The built-in high accuracy DAC converts the received VID code into a voltage value ranging from 0V to 1.52V with 5mV step voltage. The system accuracy of the controller can reach 0.8%. The RT8167B operates in continuous conduction mode or diode emulation mode, according to the SVID command. The maximum efficiency can reach up to 90% in different operating modes according to different load conditions. The droop function (load line) can be easily programmed by setting the DC gain of the error amplifier. With proper compensation, the load transient response can achieve optimized AVP performance.

The output voltage transition slew rate is set via the SVID interface. The RT8167B supports both DCR and sense resistor current sensing. The RT8167B provides VR\_READY and thermal throttling output signals for IMVP7 CPU and GPU core. This part also features complete fault protection functions including over voltage, under voltage, negative voltage, over current and thermal shutdown.

The RT8167B is available in a WQFN-40L 5x5 small footprint package.

## Features

- **Dual Single-Phase PWM Controller for CPU Core and GPU Core Power**
- **IMVP7 Compatible Power Management States**
- **Serial VID Interface**
- **G-NAVP™ Topology**
- **AVP for CPU VR Only**
- **0.5% DAC Accuracy**
- **0.8% System Accuracy**
- **Differential Remote Voltage Sensing**
- **Built-in ADC for Platform Programming**
  - **SETINI/SETINIA for CPU/GPU Core VR Initial Startup Voltage**
  - **TMPMAX to Set Platform Maximum Temperature**
  - **ICCMAX/ICCMAXA for CPU/GPU Core VR Maximum Current**
- **Power Good Indicator : VR\_READY/VRA\_READY for CPU/GPU Core Power**
- **Thermal Throttling Indicator : VRHOT**
- **Diode Emulation Mode at Light Load Condition**
- **Fast Line/Load Transient Response**
- **Switching Frequency up to 1MHz per Phase**
- **OVP, UVP, NVP, OTP, UVLO, OCP**
- **Small 40-Lead WQFN Package**
- **RoHS Compliant and Halogen Free**

## Applications

- IMVP7 Intel CPU/GPU Core Power Supply
- Laptop Computers
- AVP Step-Down Converter

## Ordering Information

RT8167B□□

- Package Type  
QW : WQFN-40L 5x5 (W-Type)
- Lead Plating System  
G : Green (Halogen Free and Pb Free)

Note :

Richtek products are :

- ▶ RoHS compliant and compatible with the current requirements of IPC/JEDEC J-STD-020.
- ▶ Suitable for use in SnPb or Pb-free soldering processes.

## Marking Information



RT8167BGQW : Product Number  
YMDNN : Date Code

## Pin Configurations

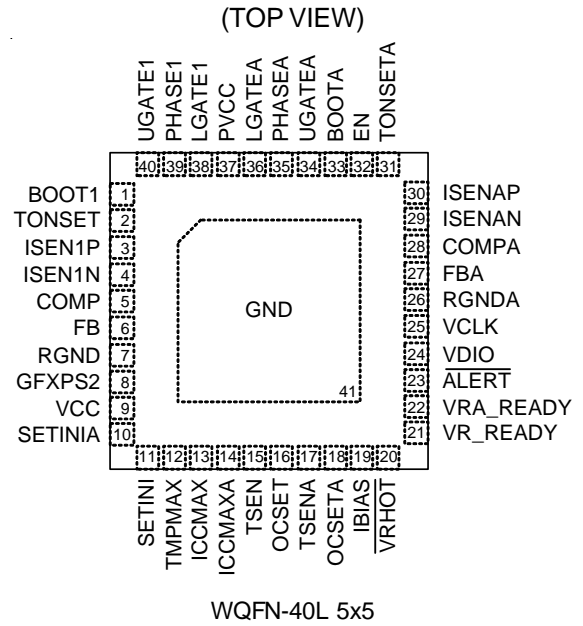

**Typical Application Circuit**

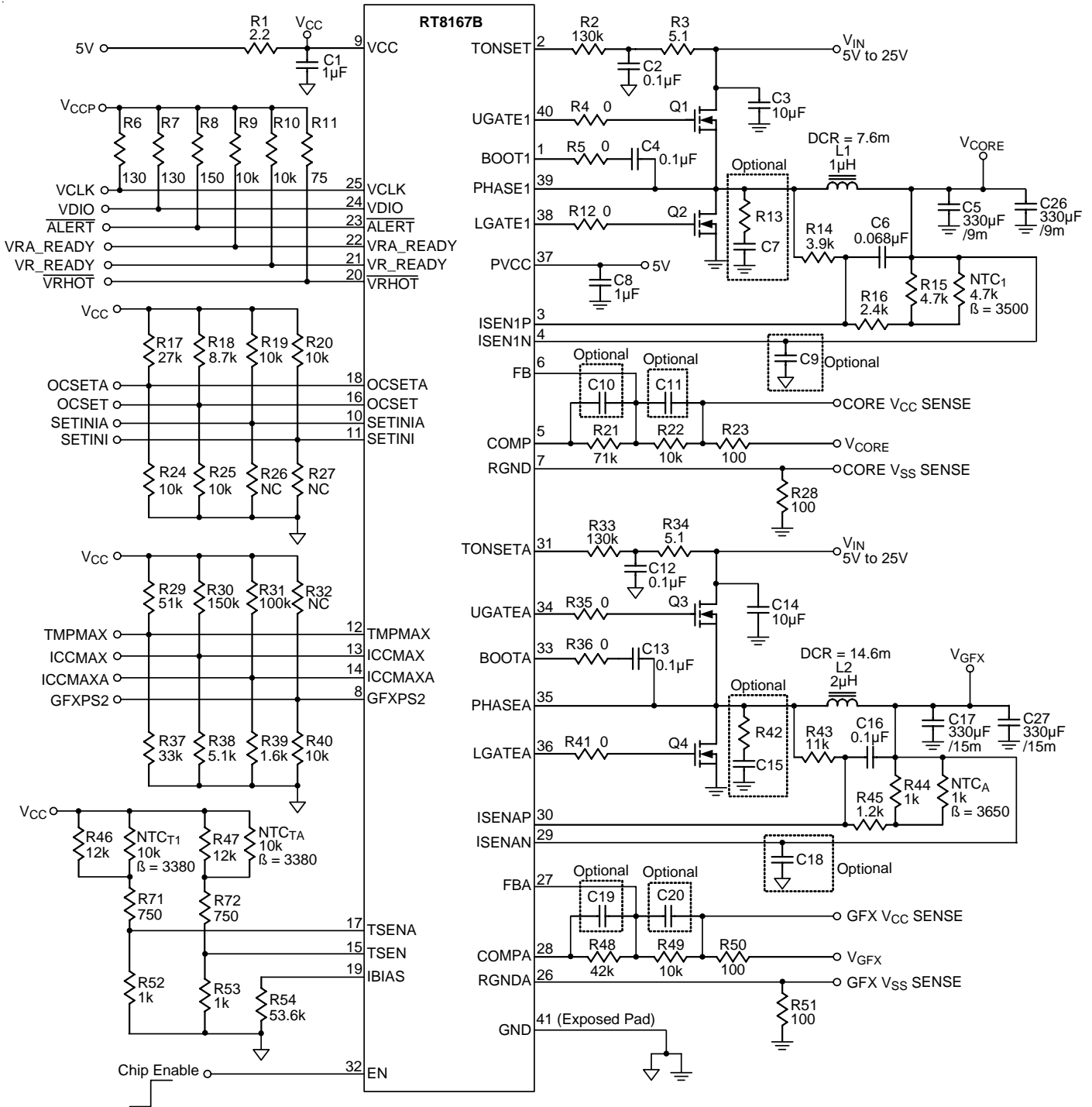

Table 1. IMVP7/VR12 Compliant VID Table

VID7	VID6	VID5	VID4	VID3	VID2	VID1	VID0	H1	H0	VDAC Voltage
0	0	0	0	0	0	0	0	0	0	0.000
0	0	0	0	0	0	0	1	0	1	0.250
0	0	0	0	0	0	1	0	0	2	0.255
0	0	0	0	0	0	1	1	0	3	0.260
0	0	0	0	0	1	0	0	0	4	0.265
0	0	0	0	0	1	0	1	0	5	0.270
0	0	0	0	0	1	1	0	0	6	0.275
0	0	0	0	0	1	1	1	0	7	0.280
0	0	0	0	1	0	0	0	0	8	0.285
0	0	0	0	1	0	0	1	0	9	0.290
0	0	0	0	1	0	1	0	0	A	0.295
0	0	0	0	1	0	1	1	0	B	0.300
0	0	0	0	1	1	0	0	0	C	0.305
0	0	0	0	1	1	0	1	0	D	0.310
0	0	0	0	1	1	1	0	0	E	0.315
0	0	0	0	1	1	1	1	0	F	0.320
0	0	0	1	0	0	0	0	1	0	0.325
0	0	0	1	0	0	0	1	1	1	0.330
0	0	0	1	0	0	1	0	1	2	0.335
0	0	0	1	0	0	1	1	1	3	0.340
0	0	0	1	0	1	0	0	1	4	0.345
0	0	0	1	0	1	0	1	1	5	0.350
0	0	0	1	0	1	1	0	1	6	0.355
0	0	0	1	0	1	1	1	1	7	0.360
0	0	0	1	1	0	0	0	1	8	0.365
0	0	0	1	1	0	0	1	1	9	0.370
0	0	0	1	1	0	1	0	1	A	0.375
0	0	0	1	1	0	1	1	1	B	0.380
0	0	0	1	1	1	0	0	1	C	0.385
0	0	0	1	1	1	0	1	1	D	0.390
0	0	0	1	1	1	1	0	1	E	0.395
0	0	0	1	1	1	1	1	1	F	0.400
0	0	1	0	0	0	0	0	2	0	0.405
0	0	1	0	0	0	0	1	2	1	0.410
0	0	1	0	0	0	1	0	2	2	0.415

To be continued

VID7	VID6	VID5	VID4	VID3	VID2	VID1	VID0	H1	H0	DAC Voltage
0	0	1	0	0	0	1	1	2	3	0.420
0	0	1	0	0	1	0	0	2	4	0.425
0	0	1	0	0	1	0	1	2	5	0.430
0	0	1	0	0	1	1	0	2	6	0.435
0	0	1	0	0	1	1	1	2	7	0.440
0	0	1	0	1	0	0	0	2	8	0.445
0	0	1	0	1	0	0	1	2	9	0.450
0	0	1	0	1	0	1	0	2	A	0.455
0	0	1	0	1	0	1	1	2	B	0.460
0	0	1	0	1	1	0	0	2	C	0.465
0	0	1	0	1	1	0	1	2	D	0.470
0	0	1	0	1	1	1	0	2	E	0.475
0	0	1	0	1	1	1	1	2	F	0.480
0	0	1	1	0	0	0	0	3	0	0.485
0	0	1	1	0	0	0	1	3	1	0.490
0	0	1	1	0	0	1	0	3	2	0.495
0	0	1	1	0	0	1	1	3	3	0.500
0	0	1	1	0	1	0	0	3	4	0.505
0	0	1	1	0	1	0	1	3	5	0.510
0	0	1	1	0	1	1	0	3	6	0.515
0	0	1	1	0	1	1	1	3	7	0.520
0	0	1	1	1	0	0	0	3	8	0.525
0	0	1	1	1	0	0	1	3	9	0.530
0	0	1	1	1	0	1	0	3	A	0.535
0	0	1	1	1	0	1	1	3	B	0.540
0	0	1	1	1	1	0	0	3	C	0.545
0	0	1	1	1	1	0	1	3	D	0.550
0	0	1	1	1	1	1	0	3	E	0.555
0	0	1	1	1	1	1	1	3	F	0.560
0	1	0	0	0	0	0	0	4	0	0.565
0	1	0	0	0	0	0	1	4	1	0.570
0	1	0	0	0	0	1	0	4	2	0.575
0	1	0	0	0	0	1	1	4	3	0.580
0	1	0	0	0	1	0	0	4	4	0.585
0	1	0	0	0	1	0	1	4	5	0.590

*To be continued*

VID7	VID6	VID5	VID4	VID3	VID2	VID1	VID0	H1	H0	DAC Voltage
0	1	0	0	0	1	1	0	4	6	0.595
0	1	0	0	0	1	1	1	4	7	0.600
0	1	0	0	1	0	0	0	4	8	0.605
0	1	0	0	1	0	0	1	4	9	0.610
0	1	0	0	1	0	1	0	4	A	0.615
0	1	0	0	1	0	1	1	4	B	0.620
0	1	0	0	1	1	0	0	4	C	0.625
0	1	0	0	1	1	0	1	4	D	0.630
0	1	0	0	1	1	1	0	4	E	0.635
0	1	0	0	1	1	1	1	4	F	0.640
0	1	0	1	0	0	0	0	5	0	0.645
0	1	0	1	0	0	0	1	5	1	0.650
0	1	0	1	0	0	1	0	5	2	0.655
0	1	0	1	0	0	1	1	5	3	0.660
0	1	0	1	0	1	0	0	5	4	0.665
0	1	0	1	0	1	0	1	5	5	0.670
0	1	0	1	0	1	1	0	5	6	0.675
0	1	0	1	0	1	1	1	5	7	0.680
0	1	0	1	1	0	0	0	5	8	0.685
0	1	0	1	1	0	0	1	5	9	0.690
0	1	0	1	1	0	1	0	5	A	0.695
0	1	0	1	1	0	1	1	5	B	0.700
0	1	0	1	1	1	0	0	5	C	0.705
0	1	0	1	1	1	0	1	5	D	0.710
0	1	0	1	1	1	1	0	5	E	0.715
0	1	0	1	1	1	1	1	5	F	0.720
0	1	1	0	0	0	0	0	6	0	0.725
0	1	1	0	0	0	0	1	6	1	0.730
0	1	1	0	0	0	1	0	6	2	0.735
0	1	1	0	0	0	1	1	6	3	0.740
0	1	1	0	0	1	0	0	6	4	0.745
0	1	1	0	0	1	0	1	6	5	0.750
0	1	1	0	0	1	1	0	6	6	0.755
0	1	1	0	0	1	1	1	6	7	0.760
0	1	1	0	1	0	0	0	6	8	0.765
0	1	1	0	1	0	0	1	6	9	0.770

To be continued

VID7	VID6	VID5	VID4	VID3	VID2	VID1	VID0	H1	H0	DAC Voltage
0	1	1	0	1	0	1	0	6	A	0.775
0	1	1	0	1	0	1	1	6	B	0.780
0	1	1	0	1	1	0	0	6	C	0.785
0	1	1	0	1	1	0	1	6	D	0.790
0	1	1	0	1	1	1	0	6	E	0.795
0	1	1	0	1	1	1	1	6	F	0.800
0	1	1	1	0	0	0	0	7	0	0.805
0	1	1	1	0	0	0	1	7	1	0.810
0	1	1	1	0	0	1	0	7	2	0.815
0	1	1	1	0	0	1	1	7	3	0.820
0	1	1	1	0	1	0	0	7	4	0.825
0	1	1	1	0	1	0	1	7	5	0.830
0	1	1	1	0	1	1	0	7	6	0.835
0	1	1	1	0	1	1	1	7	7	0.840
0	1	1	1	1	0	0	0	7	8	0.845
0	1	1	1	1	0	0	1	7	9	0.850
0	1	1	1	1	0	1	0	7	A	0.855
0	1	1	1	1	0	1	1	7	B	0.860
0	1	1	1	1	1	0	0	7	C	0.865
0	1	1	1	1	1	0	1	7	D	0.870
0	1	1	1	1	1	1	0	7	E	0.875
0	1	1	1	1	1	1	1	7	F	0.880
1	0	0	0	0	0	0	0	8	0	0.885
1	0	0	0	0	0	0	1	8	1	0.890
1	0	0	0	0	0	1	0	8	2	0.895
1	0	0	0	0	0	1	1	8	3	0.900
1	0	0	0	0	1	0	0	8	4	0.905
1	0	0	0	0	1	0	1	8	5	0.910
1	0	0	0	0	1	1	0	8	6	0.915
1	0	0	0	0	1	1	1	8	7	0.920
1	0	0	0	1	0	0	0	8	8	0.925
1	0	0	0	1	0	0	1	8	9	0.930
1	0	0	0	1	0	1	0	8	A	0.935
1	0	0	0	1	0	1	1	8	B	0.940
1	0	0	0	1	1	0	0	8	C	0.945
1	0	0	0	1	1	0	1	8	D	0.950

*To be continued*

VID7	VID6	VID5	VID4	VID3	VID2	VID1	VID0	H1	H0	DAC Voltage
1	0	0	0	1	1	1	0	8	E	0.955
1	0	0	0	1	1	1	1	8	F	0.960
1	0	0	1	0	0	0	0	9	0	0.965
1	0	0	1	0	0	0	1	9	1	0.970
1	0	0	1	0	0	1	0	9	2	0.975
1	0	0	1	0	0	1	1	9	3	0.980
1	0	0	1	0	1	0	0	9	4	0.985
1	0	0	1	0	1	0	1	9	5	0.990
1	0	0	1	0	1	1	0	9	6	0.995
1	0	0	1	0	1	1	1	9	7	1.000
1	0	0	1	1	0	0	0	9	8	1.005
1	0	0	1	1	0	0	1	9	9	1.010
1	0	0	1	1	0	1	0	9	A	1.015
1	0	0	1	1	0	1	1	9	B	1.020
1	0	0	1	1	1	0	0	9	C	1.025
1	0	0	1	1	1	0	1	9	D	1.030
1	0	0	1	1	1	1	0	9	E	1.035
1	0	0	1	1	1	1	1	9	F	1.040
1	0	1	0	0	0	0	0	A	0	1.045
1	0	1	0	0	0	0	1	A	1	1.050
1	0	1	0	0	0	1	0	A	2	1.055
1	0	1	0	0	0	1	1	A	3	1.060
1	0	1	0	0	1	0	0	A	4	1.065
1	0	1	0	0	1	0	1	A	5	1.070
1	0	1	0	0	1	1	0	A	6	1.075
1	0	1	0	0	1	1	1	A	7	1.080
1	0	1	0	1	0	0	0	A	8	1.085
1	0	1	0	1	0	0	1	A	9	1.090
1	0	1	0	1	0	1	0	A	A	1.095
1	0	1	0	1	0	1	1	A	B	1.100
1	0	1	0	1	1	0	0	A	C	1.105
1	0	1	0	1	1	0	1	A	D	1.110
1	0	1	0	1	1	1	0	A	E	1.115
1	0	1	0	1	1	1	1	A	F	1.120
1	0	1	1	0	0	0	0	B	0	1.125
1	0	1	1	0	0	0	1	B	1	1.130

To be continued



VID7	VID6	VID5	VID4	VID3	VID2	VID1	VID0	H1	H0	DAC Voltage
1	0	1	1	0	0	1	0	B	2	1.135
1	0	1	1	0	0	1	1	B	3	1.140
1	0	1	1	0	1	0	0	B	4	1.145
1	0	1	1	0	1	0	1	B	5	1.150
1	0	1	1	0	1	1	0	B	6	1.155
1	0	1	1	0	1	1	1	B	7	1.160
1	0	1	1	1	0	0	0	B	8	1.165
1	0	1	1	1	0	0	1	B	9	1.170
1	0	1	1	1	0	1	0	B	A	1.175
1	0	1	1	1	0	1	1	B	B	1.180
1	0	1	1	1	1	0	0	B	C	1.185
1	0	1	1	1	1	0	1	B	D	1.190
1	0	1	1	1	1	1	0	B	E	1.195
1	0	1	1	1	1	1	1	B	F	1.200
1	1	0	0	0	0	0	0	C	0	1.205
1	1	0	0	0	0	0	1	C	1	1.210
1	1	0	0	0	0	1	0	C	2	1.215
1	1	0	0	0	0	1	1	C	3	1.220
1	1	0	0	0	1	0	0	C	4	1.225
1	1	0	0	0	1	0	1	C	5	1.230
1	1	0	0	0	1	1	0	C	6	1.235
1	1	0	0	0	1	1	1	C	7	1.240
1	1	0	0	1	0	0	0	C	8	1.245
1	1	0	0	1	0	0	1	C	9	1.250
1	1	0	0	1	0	1	0	C	A	1.255
1	1	0	0	1	0	1	1	C	B	1.260
1	1	0	0	1	1	0	0	C	C	1.265
1	1	0	0	1	1	0	1	C	D	1.270
1	1	0	0	1	1	1	0	C	E	1.275
1	1	0	0	1	1	1	1	C	F	1.280
1	1	0	1	0	0	0	0	D	0	1.285
1	1	0	1	0	0	0	1	D	1	1.290
1	1	0	1	0	0	1	0	D	2	1.295
1	1	0	1	0	0	1	1	D	3	1.300
1	1	0	1	0	1	0	0	D	4	1.305
1	1	0	1	0	1	0	1	D	5	1.310

*To be continued*

VID7	VID6	VID5	VID4	VID3	VID2	VID1	VID0	H1	H0	DAC Voltage
1	1	0	1	0	1	1	0	D	6	1.315
1	1	0	1	0	1	1	1	D	7	1.320
1	1	0	1	1	0	0	0	D	8	1.325
1	1	0	1	1	0	0	1	D	9	1.330
1	1	0	1	1	0	1	0	D	A	1.335
1	1	0	1	1	0	1	1	D	B	1.340
1	1	0	1	1	1	0	0	D	C	1.345
1	1	0	1	1	1	0	1	D	D	1.350
1	1	0	1	1	1	1	0	D	E	1.355
1	1	0	1	1	1	1	1	D	F	1.360
1	1	1	0	0	0	0	0	E	0	1.365
1	1	1	0	0	0	0	1	E	1	1.370
1	1	1	0	0	0	1	0	E	2	1.375
1	1	1	0	0	0	1	1	E	3	1.380
1	1	1	0	0	1	0	0	E	4	1.385
1	1	1	0	0	1	0	1	E	5	1.390
1	1	1	0	0	1	1	0	E	6	1.395
1	1	1	0	0	1	1	1	E	7	1.400
1	1	1	0	1	0	0	0	E	8	1.405
1	1	1	0	1	0	0	1	E	9	1.410
1	1	1	0	1	0	1	0	E	A	1.415
1	1	1	0	1	0	1	1	E	B	1.420
1	1	1	0	1	1	0	0	E	C	1.425
1	1	1	0	1	1	0	1	E	D	1.430
1	1	1	0	1	1	1	0	E	E	1.435
1	1	1	0	1	1	1	1	E	F	1.440
1	1	1	1	0	0	0	0	F	0	1.445
1	1	1	1	0	0	0	1	F	1	1.450
1	1	1	1	0	0	1	0	F	2	1.455
1	1	1	1	0	0	1	1	F	3	1.460
1	1	1	1	0	1	0	0	F	4	1.465
1	1	1	1	0	1	0	1	F	5	1.470
1	1	1	1	0	1	1	0	F	6	1.475
1	1	1	1	0	1	1	1	F	7	1.480
1	1	1	1	1	0	0	0	F	8	1.485

*To be continued*

VID7	VID6	VID5	VID4	VID3	VID2	VID1	VID0	H1	H0	DAC Voltage
1	1	1	1	1	0	0	1	F	9	1.490
1	1	1	1	1	0	1	0	F	A	1.495
1	1	1	1	1	0	1	1	F	B	1.500
1	1	1	1	1	1	0	0	F	C	1.505
1	1	1	1	1	1	0	1	F	D	1.510
1	1	1	1	1	1	1	0	F	E	1.515
1	1	1	1	1	1	1	1	F	F	1.520

## Functional Pin Description

Pin No.	Pin Name	Pin Function
1	BOOT1	CPU VR Bootstrap Power Pin. This pin powers the high side MOSFET drivers. Connect this pin to the PHASE1 pin with a bootstrap capacitor.
2	TONSET	Single-Phase CPU VR On-Time Setting Pin. Connect this pin to $V_{IN}$ with a resistor to set ripple size in PWM mode.
3	ISEN1P	Positive Current Sense Input Pin of CPU VR.
4	ISEN1N	Negative Current Sense Input Pin of CPU VR.
5	COMP	CPU VR Compensation Pin. This pin is the output of the error amplifier.
6	FB	CPU VR Feedback Pin. This pin is the inverting input node of the error amplifier.
7	RGND	Return Ground for CPU VR. This pin is the inverting input node for differential remote voltage sensing.
8	GFXPS2	Set Pin for GPU VR Operation Mode. Logic-high on this pin will force the GPU VR to enter DCM.
9	VCC	Controller Power Supply Pin. Connect this pin to GND via a ceramic capacitor larger than $1\mu\text{F}$ .
10	SETINIA	ADC Input for Single-Phase GPU VR VBOOT Voltage Setting.
11	SETINI	ADC Input for Single-Phase CPU VR VBOOT Voltage Setting.
12	TMPMAX	ADC Input for Single-Phase CPU VR Maximum Temperature Setting.
13	ICCMAX	ADC Input for Single-Phase CPU VR Maximum Current Setting.
14	ICCMAXA	ADC Input for Single-Phase GPU VR Maximum Current Setting.
15	TSEN	Thermal Monitor Sense Input Pin for CPU VR.
16	OCSET	Set Pin for Single-Phase CPU VR Over Current Protection Threshold. Connect a resistive voltage divider from VCC to ground, and connect the joint of the voltage divider to the OCSET pin. The voltage, $V_{OCSET}$ , at this pin sets the over current threshold, $I_{LIMIT}$ , for CPU VR.
17	TSENA	Thermal Monitor Sense Input for GPU VR.
18	OCSETA	Set Pin for Single-Phase GPU VR Over Current Protection Threshold. Connect a resistive voltage divider from VCC to ground, and connect the joint of the voltage divider to the OCSETA pin. The voltage, $V_{OCSETA}$ , at this pin sets the over current threshold, $I_{LIMIT}$ , for GPU VR.
19	IBIAS	Internal Bias Current Setting. Connect a $53.6\text{k}\Omega$ resistor from this pin to GND to set the internal bias current.
20	$\overline{\text{VRHOT}}$	Thermal Monitor Output Pin (active low).
21	VR_READY	CPU VR Voltage Ready Indicator. This pin has an open drain output.
22	VRA_READY	GPU VR Voltage Ready Indicator. This pin has an open drain output.
23	$\overline{\text{ALERT}}$	Alert Line of SVID Interface (active low). This pin has an open drain output.
24	VDIO	Data Transmission Line of SVID Interface.
25	VCLK	Clock Signal Line of SVID Interface.
26	RGNDA	Return Ground for Single-Phase GPU VR. This pin is the inverting input node for differential remote voltage sensing.
27	FBA	GPU VR Feedback Pin. This pin is the inverting input node of the error amplifier.
28	COMPA	Single-Phase GPU VR Compensation Pin. This pin is the output of the error amplifier.
29	ISENAN	Negative Current Sense Input Pin of Single-Phase GPU VR.
30	ISENAP	Positive Current Sense Input Pin of Single-Phase GPU VR.
31	TONSETA	Single-Phase GPU VR On-Time Setting Pin. Connect this pin to $V_{IN}$ with a resistor to set ripple size in PWM mode.

To be continued

Pin No.	Pin Name	Pin Function
32	EN	Voltage Regulator Enable Signal Input Pin.
33	BOOTA	GPU VR Bootstrap Power Pin. This pin powers the high side MOSFET drivers. Connect this pin to the PHASEA pin with a bootstrap capacitor.
34	UGATEA	Upper Gate Driver of GPU VR. This pin drives the high side MOSFET of GPU VR.
35	PHASEA	Switch Node of GPU VR. This pin is the return node of the high side MOSFET driver for GPU VR. Connect this pin to the joint of the source of high side MOSFET, drain of the low side MOSFET, and the output inductor.
36	LGATEA	Lower Gate Driver of GPU VR. This pin drives the low side MOSFET of GPU VR.
37	PVCC	MOSFET Driver Power Supply Pin. Connect this pin to GND via a ceramic capacitor larger than 1 $\mu$ F.
38	LGATE1	Lower Gate Driver of CPU VR. This pin drives the low side MOSFET of CPU VR.
39	PHASE1	Switch Node of CPU VR. This pin is the return node of the high side driver for CPU VR. Connect this pin to the joint of the source of high side MOSFET, drain of the low side MOSFET, and the output inductor.
40	UGATE1	Upper Gate Driver of CPU VR. This pin drives the high side MOSFET of CPU VR.
41 (Exposed Pad)	GND	Ground of Low Side MOSFET Driver. The exposed pad must be soldered to a large PCB and connected to GND for maximum power dissipation.



**Absolute Maximum Ratings** (Note 1)

- PVCC, VCC to GND ----- -0.3V to 6.5V
- RGNDx to GND ----- -0.3V to 0.3V
- TONSETx to GND ----- -0.3V to 28V
- Others ----- -0.3V to (V<sub>CC</sub> + 0.3V)
- BOOTx to PHASEx ----- -0.3V to 6.5V
- PHASEx to GND
  - DC ----- -3V to 28V
  - <20ns ----- -8V to 32V
- UGATEx to PHASEx
  - DC ----- -0.3V to (BOOTx – PHASEx)
  - <20ns ----- -5V to 7.5V
- LGATEx to GND
  - DC ----- -0.3V to (PVCC + 0.3V)
  - <20ns ----- -2.5V to 7.5V
- Power Dissipation, P<sub>D</sub> @ T<sub>A</sub> = 25°C
  - WQFN–40L 5x5 ----- 2.778W
- Package Thermal Resistance (Note 2)
  - WQFN–40L 5x5, θ<sub>JA</sub> ----- 36°C/W
  - WQFN–40L 5x5, θ<sub>JC</sub> ----- 6°C/W
- Junction Temperature ----- 150°C
- Lead Temperature (Soldering, 10 sec.) ----- 260°C
- Storage Temperature Range ----- -65°C to 150°C
- ESD Susceptibility (Note 3)
  - HBM (Human Body Mode) ----- 2kV
  - MM (Machine Mode) ----- 200V

**Recommended Operating Conditions** (Note 4)

- Supply Voltage, V<sub>CC</sub> ----- 4.5V to 5.5V
- Input Voltage, V<sub>IN</sub> ----- 5V to 25V
- Junction Temperature Range ----- -40°C to 125°C
- Ambient Temperature Range ----- -40°C to 85°C

**Electrical Characteristics**

(V<sub>CC</sub> = 5V, T<sub>A</sub> = 25°C, unless otherwise specified)

Parameter	Symbol	Test Conditions	Min	Typ	Max	Unit
<b>Supply Input</b>						
Input Voltage Range	V <sub>CC</sub> /V <sub>PVCC</sub>	V <sub>EN</sub> = 1.05V, Not Switching	4.5	5	5.5	V
	V <sub>IN</sub>	Battery Input Voltage	5	--	25	V
Supply Current (V <sub>CC</sub> + PVCC)	I <sub>VCC</sub> + I <sub>PVCC</sub>	V <sub>EN</sub> = 1.05V, Not Switching	--	12	20	mA
Supply Current (TONSETx)	I <sub>TONSETx</sub>	V <sub>FB</sub> = 1V, V <sub>IN</sub> = 12V, R <sub>TON</sub> = 100kΩ	--	110	--	μA

*To be continued*

Parameter	Symbol	Test Conditions	Min	Typ	Max	Unit
Shutdown Current (PVCC + V <sub>CC</sub> )	I <sub>VCC_SHDN</sub> + I <sub>PVCC_SHDN</sub>	V <sub>EN</sub> = 0V	--	--	5	μA
Shutdown Current (TONSET <sub>x</sub> )	I <sub>TONSET<sub>x</sub>_SHDN</sub>	V <sub>EN</sub> = 0V	--	--	5	μA
<b>TON Setting</b>						
TONSET <sub>x</sub> Voltage	V <sub>TONSET<sub>x</sub></sub>	I <sub>RTON</sub> = 80μA, V <sub>FB<sub>x</sub></sub> = 1V	0.95	1.075	1.2	0V
On-Time	t <sub>ON</sub>	I <sub>RTON</sub> = 80μA, V <sub>FB<sub>x</sub></sub> = 1V	315	350	385	ns
TONSET <sub>x</sub> Input Current Range	I <sub>RTON</sub>	V <sub>FB<sub>x</sub></sub> = 1.1V	25	--	280	μA
Minimum Off-Time	T <sub>OFF_MIN</sub>		--	350	--	ns
<b>GFX VR Forced DEM</b>						
GFXPS2 <sub>x</sub> Enable Threshold	V <sub>GFXPS</sub>		4.3	--	--	V
GFXPS2 <sub>x</sub> Disable Threshold	V <sub>GFXPS</sub>		--	--	0.7	V
<b>References and System Output Voltage</b>						
DAC Accuracy (PS0/PS1)	V <sub>FB<sub>x</sub></sub>	VID <sub>SVID</sub> Setting = 1.000V~1.520V OFS <sub>SVID</sub> Setting = 0V	-0.5	0	0.5	%VID
		VID <sub>SVID</sub> Setting = 0.800V~1.000V OFS <sub>SVID</sub> Setting = 0V	-5	0	5	mV
		VID <sub>SVID</sub> Setting = 0.500V~0.800V OFS <sub>SVID</sub> Setting = 0V	-8	0	8	
		VID <sub>SVID</sub> Setting = 0.250V~0.500V OFS <sub>SVID</sub> Setting = 0V	-8	0	8	
		VID <sub>SVID</sub> Setting = 1.100V OFS <sub>SVID</sub> Setting = -0.640V~0.635V	-10	0	10	
SETIN <sub>ix</sub> Voltage	V <sub>SETIN<sub>ix</sub></sub>	V <sub>INI_CORE</sub> = 0V, V <sub>INI_GFX</sub> = 0V	0	0.3125	0.5125	V
		V <sub>INI_CORE</sub> = 0.9V, V <sub>INI_GFX</sub> = 0.9V	0.7375	0.9375	1.1375	
		V <sub>INI_CORE</sub> = 1V, V <sub>INI_GFX</sub> = 1V	1.3625	1.5625	1.7625	
		V <sub>INI_CORE</sub> = 1.1V, V <sub>INI_GFX</sub> = 1.1V	2.6125	--	5	
IBIAS Pin Voltage	V <sub>IBIAS</sub>	R <sub>IBIAS</sub> = 53.6kΩ	2.09	2.14	2.19	V
Dynamic VID Slew Rate	SR <sub>DVID</sub>	SetVID Slow	2.5	3.125	3.75	mV/μs
		SetVID Fast	10	12.5	15	
<b>Error Amplifier</b>						
DC Gain	A <sub>DC</sub>	R <sub>L</sub> = 47kΩ (Note5)	70	80	--	dB
Gain-Bandwidth Product	GBW	C <sub>LOAD</sub> = 5pF (Note5)	--	10	--	MHz
Slew Rate	SR <sub>COMP</sub>	C <sub>LOAD</sub> = 10pF (Gain = -4, R <sub>LOAD_COMP</sub> = 47kΩ, V <sub>COMP<sub>x</sub></sub> = 0.5V to 3V)	--	5	--	V/μs
Output Voltage Range	V <sub>COMP</sub>	R <sub>L</sub> = 47kΩ	0.5	--	3.6	V
MAX Source/Sink Current	I <sub>COMP</sub>	V <sub>COMP</sub> = 2V	--	250	--	μA
Impedance of FB <sub>x</sub>	R <sub>FB<sub>x</sub></sub>		1	--	--	MΩ

To be continued



Parameter	Symbol	Test Conditions	Min	Typ	Max	Unit
<b>Current Sense Amplifier</b>						
Input Offset Voltage	V <sub>OFS_CSA</sub>		-1	--	1	mV
Impedance of Neg. Input	R <sub>ISENxN</sub>		1	--	--	MΩ
Impedance of Pos. Input	R <sub>ISENxP</sub>		1	--	--	MΩ
Current Sense Differential Input Range	V <sub>CSDIx</sub>	V <sub>FBx</sub> = 1.1V, V <sub>CSDIx</sub> = V <sub>ISENxP</sub> - V <sub>ISENxN</sub>	-50	--	100	mV
Current Sense DC Gain (Loop)	A <sub>I</sub>	V <sub>FBx</sub> = 1.1V, -30mV < V <sub>CSDIx</sub> < 50mV	--	10	--	V/V
V <sub>ISEN</sub> Linearity	V <sub>ISEN_ACC</sub>	V <sub>DAC</sub> = 1.1V -30mV < V <sub>ISEN_IN</sub> < 50mV	-1	--	1	%
<b>Gate Driver</b>						
Upper Driver Source	R <sub>UGATEx_sr</sub>	V <sub>BOOTx</sub> - V <sub>PHASEx</sub> = 5V V <sub>BOOTx</sub> - V <sub>UGATEx</sub> = 0.1V	--	1	--	Ω
Upper Driver Sink	R <sub>UGATEx_sk</sub>	V <sub>UGATEx</sub> = 0.1V	--	1	--	Ω
Lower Driver Source	R <sub>LGATEx_sr</sub>	PVCC = 5V, PVCC - V <sub>LGATEx</sub> = 0.1V	--	1	--	Ω
Lower Driver Sink	R <sub>LGATEx_sk</sub>	V <sub>LGATEx</sub> = 0.1V	--	0.5	--	Ω
Internal Boot Charging Switch On-Resistance	R <sub>BOOTx</sub>	PVCC to BOOTx	--	30	--	Ω
Zero Current Detection Threshold	V <sub>ZCD_TH</sub>	V <sub>ZCD_TH</sub> = GND - V <sub>PHASEx</sub>	--	10	--	mV
<b>Protection</b>						
Under Voltage Lock-out Threshold	V <sub>UVLO</sub>	VCC Falling edge	4.04	4.24	--	V
Under Voltage Lock-out Hysteresis	ΔV <sub>UVLO</sub>		--	100	--	mV
Over Voltage Protection Threshold	V <sub>OVP</sub>	Respect to V <sub>OUT_MAX</sub> SVID, with 1μs filter time	100	150	200	mV
Under Voltage Protection Threshold	V <sub>UVP</sub>	V <sub>UVP</sub> = V <sub>ISENxN</sub> - V <sub>REFx</sub> , 0.8V < V <sub>REFx</sub> < 1.52V, with 3μs filter time	-350	-300	-250	mV
Negative Voltage Protection Threshold	V <sub>NVP</sub>	V <sub>NVP</sub> = V <sub>ISENxN</sub> - GND	-100	-50	--	mV
Current Sense Gain for Over Current Protection	A <sub>Oc</sub>	V <sub>OCSET</sub> = 2.4V V <sub>ISENxP</sub> - V <sub>ISENxN</sub> = 50mV	--	48	--	V/V
<b>Logic Inputs</b>						
EN Input Threshold Voltage	Logic-High	V <sub>IH</sub>	With respect to 1V, 70%		0.7	V
	Logic-Low	V <sub>IL</sub>	With respect to 1V, 30%		0.3	
Leakage Current of EN			-1	--	1	μA
VCLK,VDIO Input Threshold Voltage		V <sub>IH</sub>	With respect to Intel Spec.		0.65	V
		V <sub>IL</sub>	With respect to Intel Spec.		0.45	
Leakage Current of VCLK, VDIO		I <sub>LEAK_IN</sub>	-1	--	1	μA

*To be continued*

Parameter	Symbol	Test Conditions	Min	Typ	Max	Unit
<b>ALERT</b>						
ALERT Low Voltage	$V_{\overline{\text{ALERT}}}$	$I_{\overline{\text{ALERT\_SINK}}} = 4\text{mA}$	--	--	0.4	V
<b>VR Ready</b>						
VRx_READY Low Voltage	$V_{\text{VRx\_READY}}$	$I_{\text{VRx\_READY\_SINK}} = 4\text{mA}$	--	--	0.4	V
VRx_READY Delay	$t_{\text{VRx\_READY}}$	$V_{\text{ISEN}xN} = V_{\text{BOOT}}$ to $V_{\text{VRx\_READY}}$ high	70	100	160	$\mu\text{s}$
<b>Thermal Throttling</b>						
$\overline{\text{VRHOT}}$ Output Voltage	$V_{\overline{\text{VRHOT}}}$	$I_{\overline{\text{VRHOT\_SINK}}} = 40\text{mA}$	--	0.4	--	V
<b>High Impedance Output</b>						
$\overline{\text{ALERT}}$ , VRx_READY, $\overline{\text{VRHOT}}$	$I_{\text{LEAK\_OUT}}$		-1	--	1	$\mu\text{A}$
<b>Temperature Zone</b>						
TSEN Threshold for Tmp_Zone [7] transition	$V_{\text{TSEN}x}$	100°C	--	1.8725	--	V
TSEN Threshold for Tmp_Zone [6] transition		97°C	--	1.8175	--	V
TSEN Threshold for Tmp_Zone [5] transition		94°C	--	1.7625	--	V
TSEN Threshold for Tmp_Zone [4] transition		91°C	--	1.7075	--	V
TSEN Threshold for Tmp_Zone [3] transition		88°C	--	1.6525	--	V
TSEN Threshold for Tmp_Zone [2] transition	$V_{\text{TSEN}x}$	85°C	--	1.5975	--	V
TSEN Threshold for Tmp_Zone [1] transition		82°C	--	1.5425	--	V
TSEN Threshold for Tmp_Zone [0] transition		75°C	--	1.4875	--	V
Update Period	$t_{\text{TSEN}}$		--	1600	--	$\mu\text{s}$
<b>ADC</b>						
Latency	$t_{\text{LAT}}$		--	--	400	$\mu\text{s}$
Digital Code of ICCMAX	$C_{\text{ICCMAX}1}$	$V_{\text{ICCMAX}} = 0.637\text{V}$	29	32	35	decimal
	$C_{\text{ICCMAX}2}$	$V_{\text{ICCMAX}} = 1.2642\text{V}$	61	64	67	decimal
	$C_{\text{ICCMAX}3}$	$V_{\text{ICCMAX}} = 2.5186\text{V}$	125	128	131	decimal
Digital Code of ICCMAXA	$C_{\text{ICCMAXA}1}$	$V_{\text{ICCMAXA}} = 0.1666\text{V}$	5	8	11	decimal
	$C_{\text{ICCMAXA}2}$	$V_{\text{ICCMAXA}} = 0.3234\text{V}$	13	16	19	decimal
	$C_{\text{ICCMAXA}3}$	$V_{\text{ICCMAXA}} = 0.637\text{V}$	29	32	35	decimal
Digital Code of TMPMAX	$C_{\text{TMPMAX}1}$	$V_{\text{TMPMAX}} = 1.6758\text{V}$	82	85	88	decimal
	$C_{\text{TMPMAX}2}$	$V_{\text{TMPMAX}} = 1.9698\text{V}$	97	100	103	decimal
	$C_{\text{TMPMAX}3}$	$V_{\text{TMPMAX}} = 2.4598\text{V}$	122	125	128	decimal

**Note 1.** Stresses listed as the above “Absolute Maximum Ratings” may cause permanent damage to the device. These are for stress ratings. Functional operation of the device at these or any other conditions beyond those indicated in the operational sections of the specifications is not implied. Exposure to absolute maximum rating conditions for extended periods may remain possibility to affect device reliability.

**Note 2.**  $\theta_{JA}$  is measured in the natural convection at  $T_A = 25^\circ\text{C}$  on a high effective thermal conductivity four-layer test board of JEDEC 51-7 thermal measurement standard. The measurement case position of  $\theta_{JC}$  is on the exposed pad of the package.

**Note 3.** Devices are ESD sensitive. Handling precaution is recommended.

**Note 4.** The device is not guaranteed to function outside its operating conditions.

**Note 5.** Guaranteed by design.

Typical Operating Characteristics

CORE VR Power On from EN

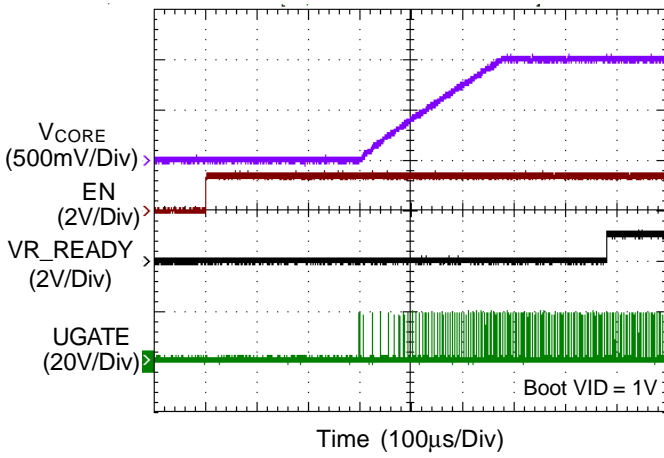

CORE VR Power Off from EN

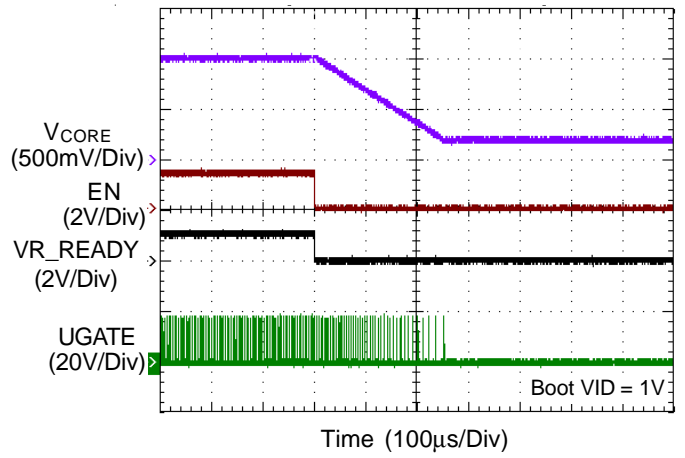

CORE VR OCP

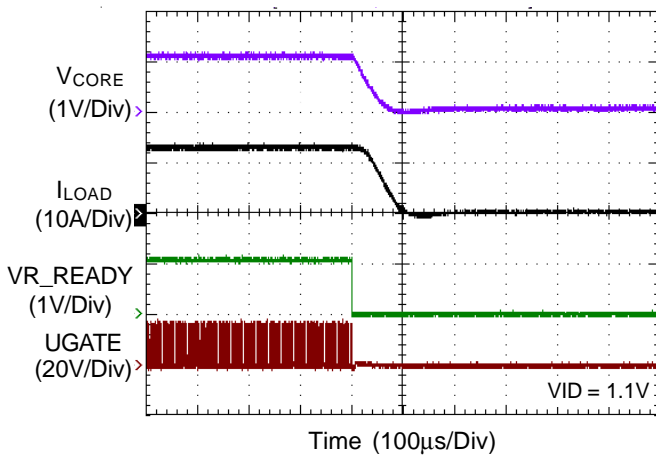

CORE VR OVP and NVP

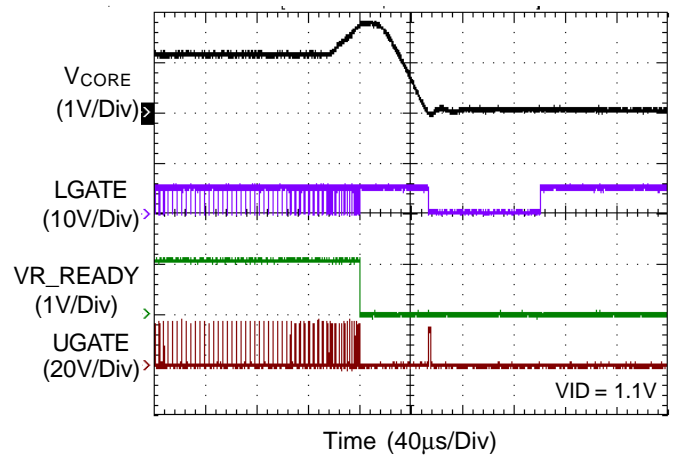

CORE VR Dynamic VID Up

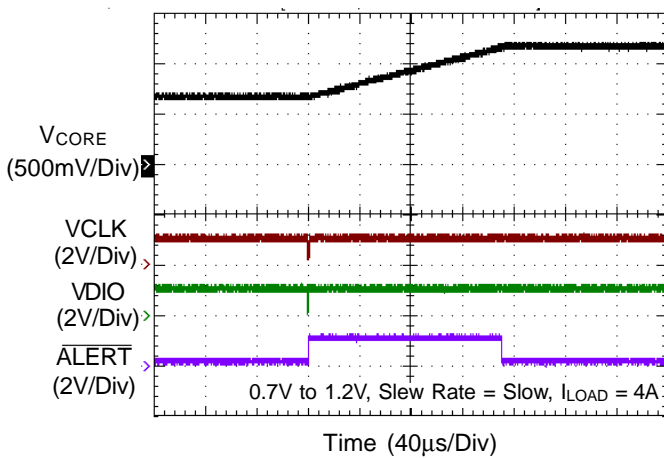

CORE VR Dynamic VID Down

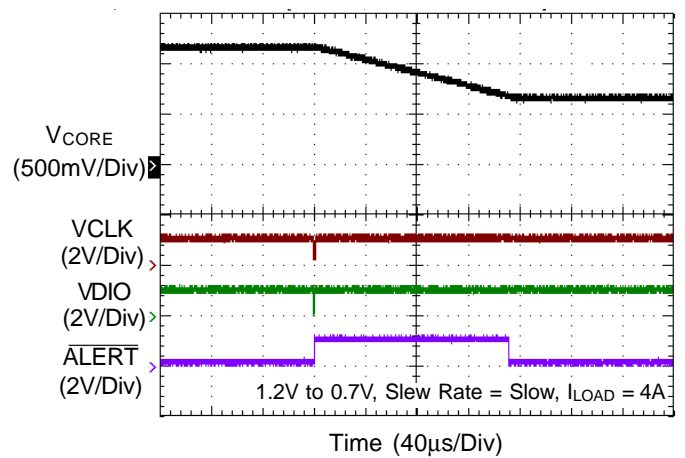

CORE VR Dynamic VID Up

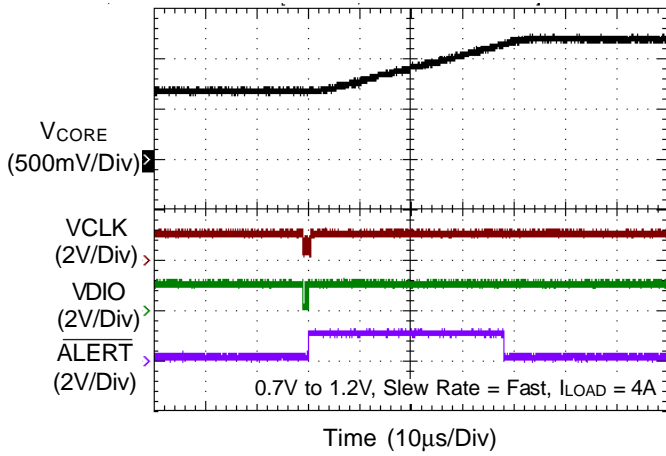

CORE VR Dynamic VID Down

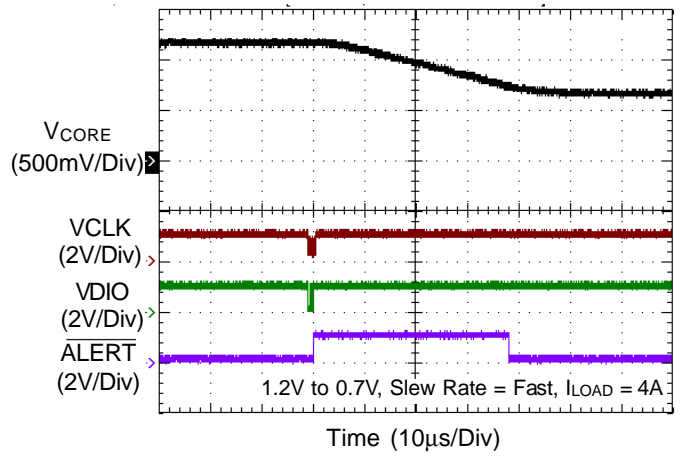

CORE VR Load Transient

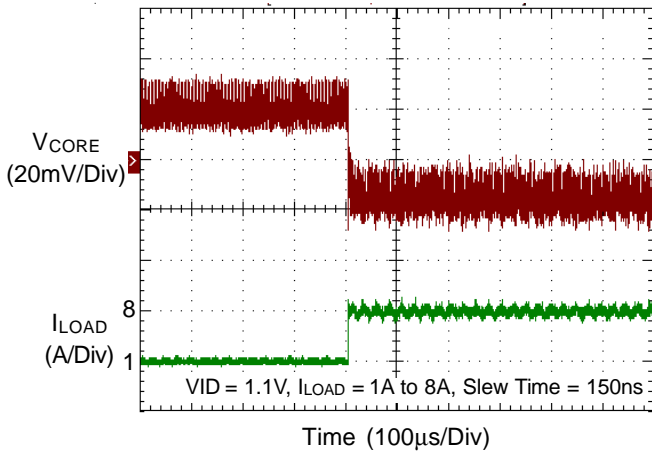

CORE VR Load Transient

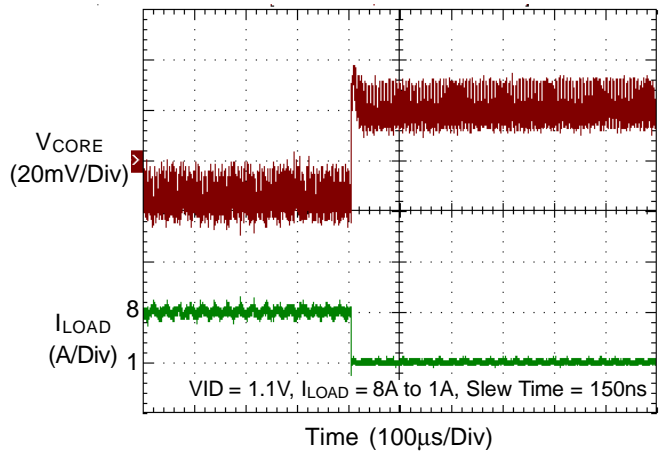

CORE VR Mode Transition

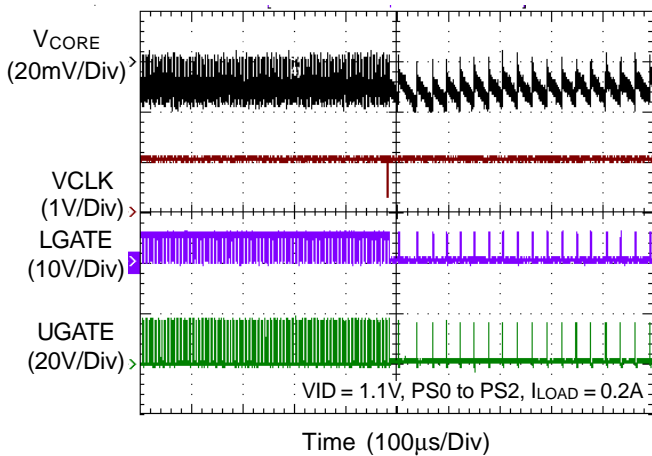

CORE VR Mode Transition

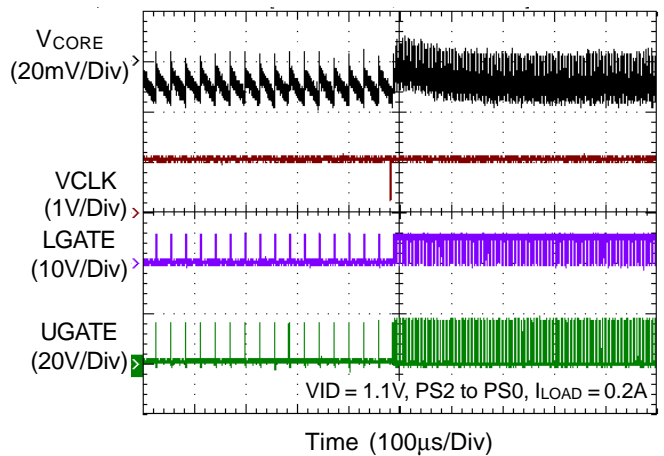

CORE VR Thermal Monitoring

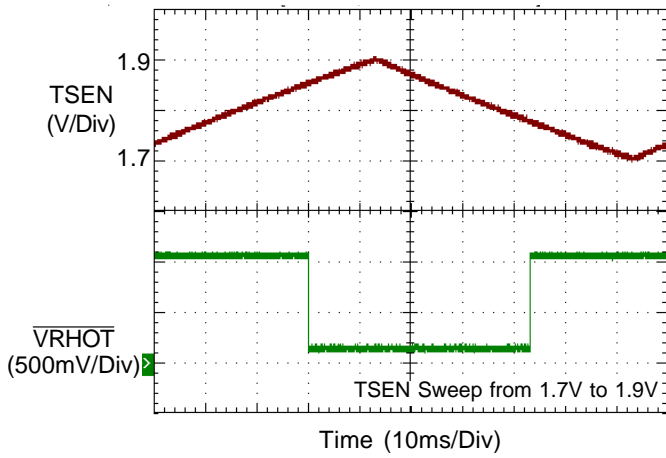

CORE VR  $V_{REF}$  vs. Temperature

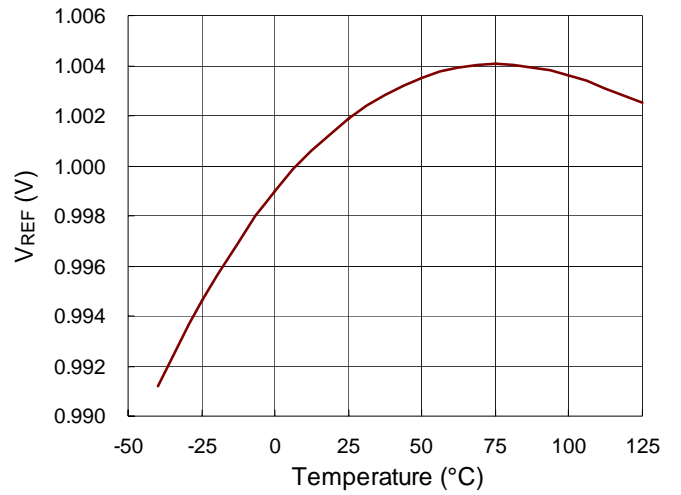

GFX VR Power On from EN

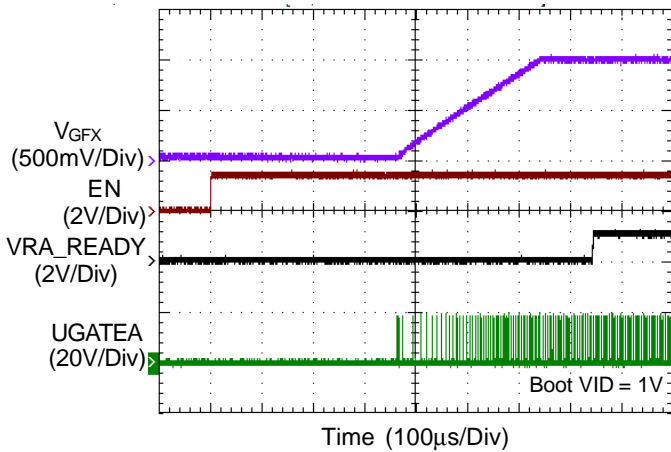

GFX VR Power Off from EN

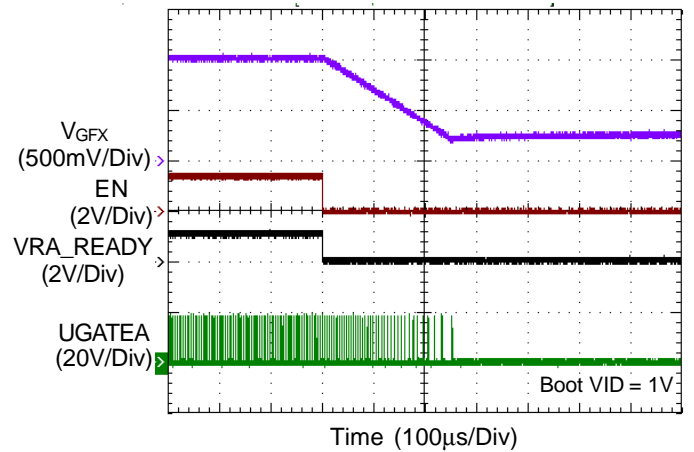

GFX VR OCP

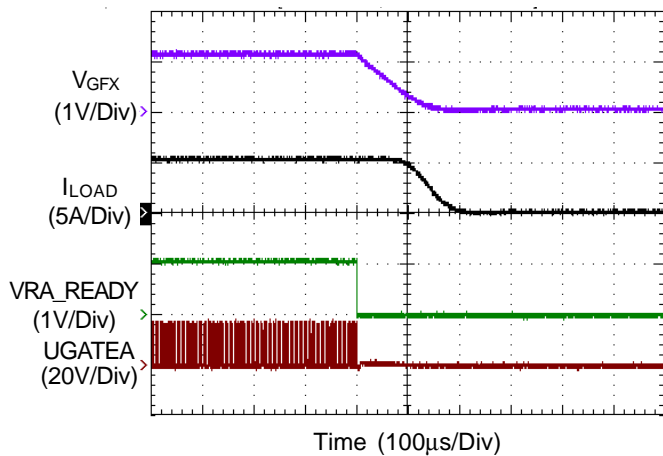

GFX VR OVP and NVP

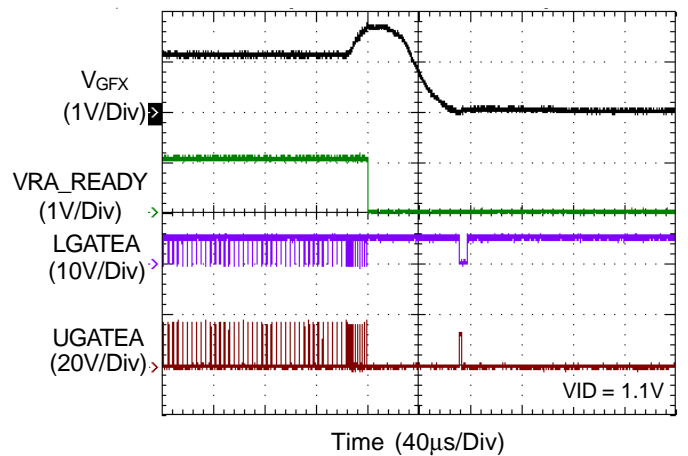

GFX VR Dynamic VID

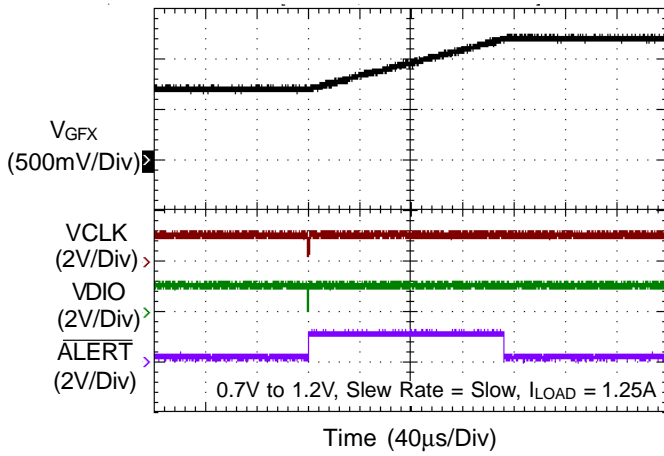

GFX VR Dynamic VID

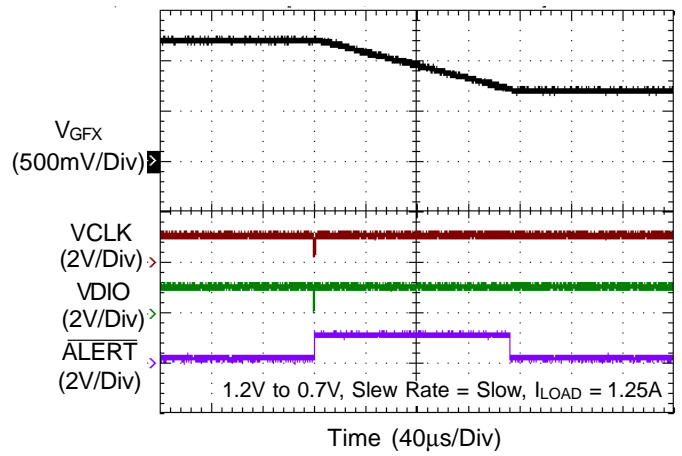

GFX VR Dynamic VID

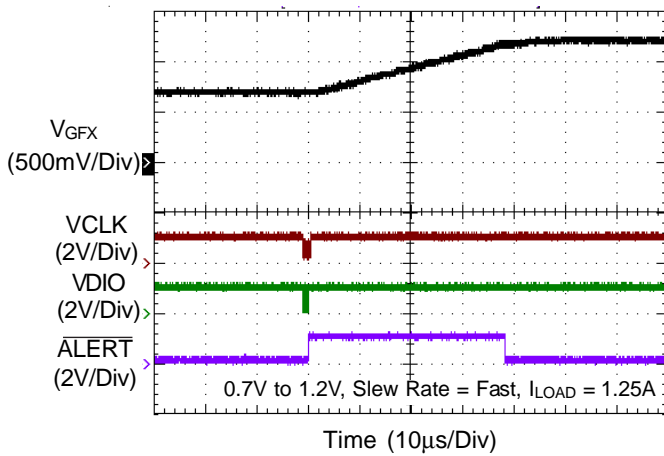

GFX VR Dynamic VID

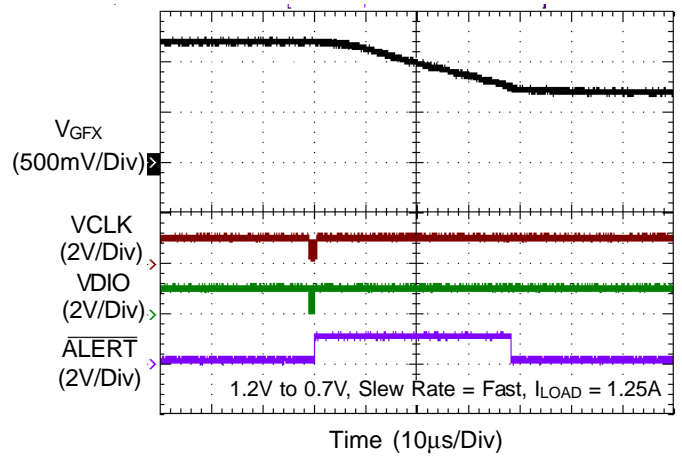

GFX VR Load Transient

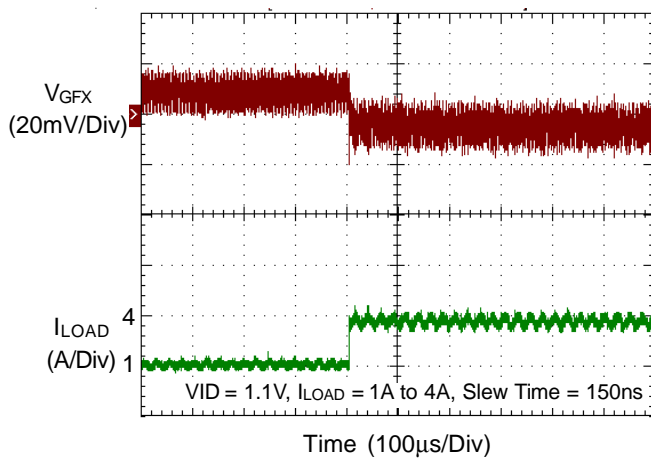

GFX VR Load Transient

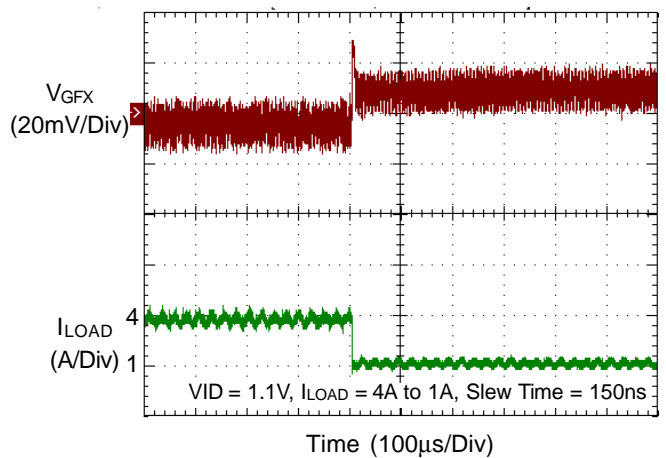

GFX VR Mode Transition

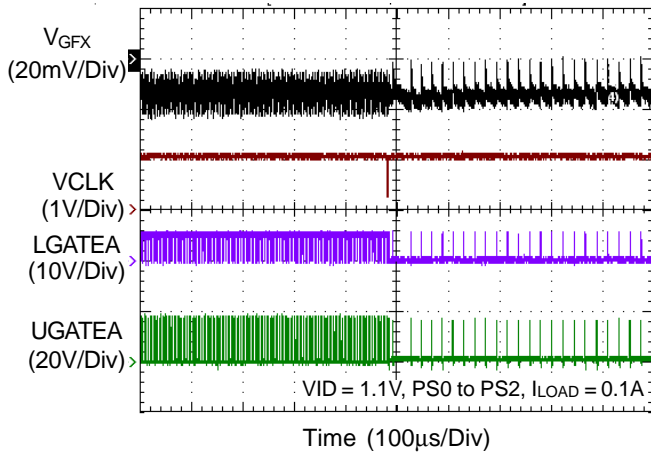

GFX VR Mode Transition

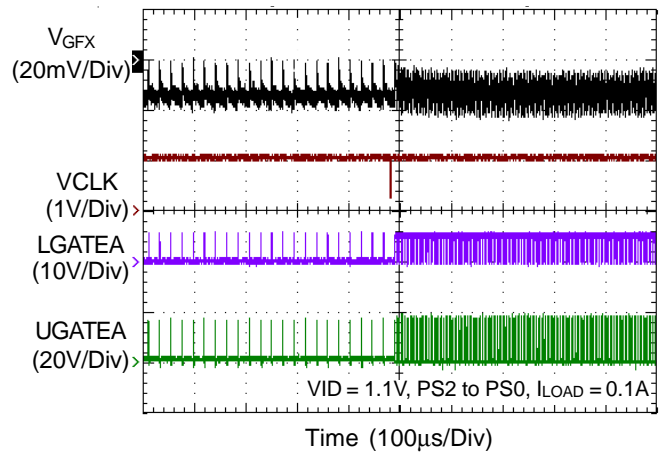

GFX VR Thermal Monitoring

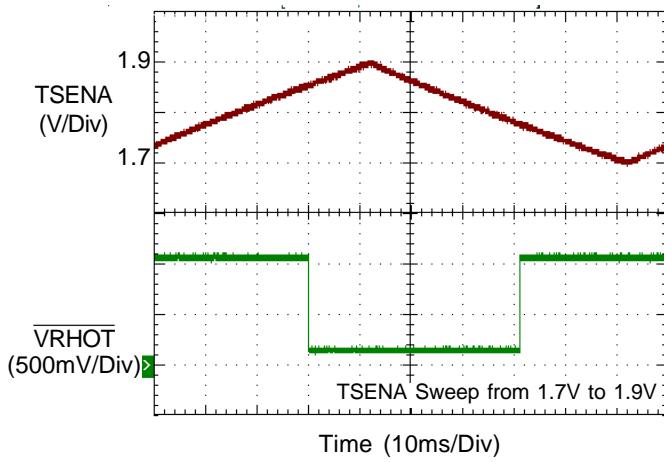

GFX VR V<sub>REF</sub> vs. Temperature

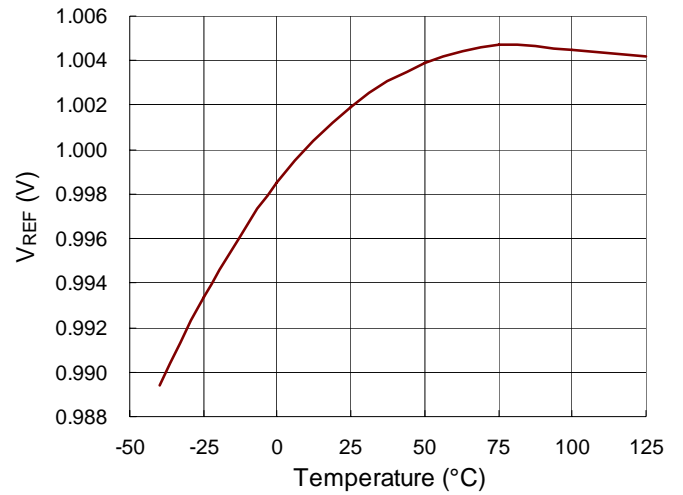



## Application Information

The RT8167B is a VR12/IMVP7 compliant, dual single-phase synchronous Buck PWM controller for the CPU CORE VR and GFX VR. The gate drivers are embedded to facilitate PCB design and reduce the total BOM cost. A serial VID (SVID) interface is built-in in the RT8167B to communicate with Intel VR12/IMVP7 compliant CPU.

The RT8167B adopts G-NAVP™ (Green Native AVP), which is Richtek's proprietary topology derived from finite DC gain compensator, making it an easy setting PWM controller to meet AVP requirements. The load line can be easily programmed by setting the DC gain of the error amplifier. The RT8167B has fast transient response due to the G-NAVP™ commanding variable switching frequency.

G-NAVP™ topology also represents a high efficiency system with green power concept. With G-NAVP™ topology, the RT8167B becomes a green power controller with high efficiency under heavy load, light load, and very light load conditions. The RT8167B supports mode transition function between CCM and DEM. These different operating states allow the overall power system to have low power loss. By utilizing the G-NAVP™ topology, the operating frequency of RT8167B varies with output voltage, load and VIN to further enhance the efficiency even in CCM.

The built-in high accuracy DAC converts the SVID code ranging from 0.25V to 1.52V with 5mV per step. The differential remote output voltage sense and high accuracy DAC allow the system to have high output voltage accuracy.

The RT8167B supports VR12/IMVP7 compatible power management states and VID on-the-fly function. The power management states include DEM in PS2/PS3 and Forced-CCM in PS1/PS0. The VID on-the-fly function has three different slew rates : Fast, Slow and Decay. The RT8167B integrates a high accuracy ADC for platform setting functions, such as no-load offset and over current level. The controller supports both DCR and sense-resistor current sensing. The RT8167B provides VR ready output signals of both CORE VR and GFX VR. It also features complete fault protection functions including over voltage, under voltage, negative voltage, over current and under voltage lockout. The RT8167B is available in a WQFN-48L 6x6 small foot print package.

### Design Tool

To help users reduce efforts and errors caused by manual calculations, a user-friendly design tool is now available on request. This design tool calculates all necessary design parameters by entering user's requirements. Please contact Richtek's representatives for details.

### Serial VID (SVID) Interface

SVID is a three-wire serial synchronous interface defined by Intel. The three wire bus includes VDIO, VCLK and  $\overline{\text{ALERT}}$  signals. The master (Intel's VR12/IMVP7 CPU) initiates and terminates SVID transactions and drives the VDIO, VCLK, and  $\overline{\text{ALERT}}$  during a transaction. The slave (RT8167B) receives the SVID transactions and acts accordingly.

## Standard Serial VID Command

Code	Commands	Master Payload Contents	Slave Payload Contents	Description
00h	not supported	N/A	N/A	N/A
01h	SetVID_Fast	VID code	N/A	Set new target VID code, VR jumps to new VID target with controlled default “fast” slew rate 12.5mV/μs.
02h	SetVID_Slow	VID code	N/A	Set new target VID code, VR jumps to new VID target with controlled default “slow” slew rate 3.125mV/μs.
03h	SetVID_Decay	VID code	N/A	Set new target VID code, VR jumps to new VID target, but does not control the slew rate. The output voltage decays at a rate proportional to the load current
04h	SetPS	Byte indicating power states	N/A	Set power state
05h	SetRegADR	Pointer of registers in data table	N/A	Set the pointer of the data register
06h	SetReg DAT	New data register content	N/A	Write the contents to the data register
07h	GetReg	Pointer of registers in data table	Specified Register Contents	Slave returns the contents of the specified register as the payload
08h - 1Fh	not supported	N/A	N/A	N/A

**Data and Configuration Register**

Index	Register Name	Description	Access	Default
00h	Vendor ID	Vendor ID, default 1Eh.	RO, Vendor	1Eh
01h	Product ID	Product ID.	RO, Vendor	65h
02h	Product Revision	Product Revision.	RO, Vendor	01h
05h	Protocol ID	SVID Protocol ID.	RO, Vendor	01h
06h	VR_Capability	Bit mapped register, identifies the SVID VR capabilities and which of the optional telemetry register are supported.	RO, Vendor	81h
10h	Status_1	Data register containing the status of VR.	R-M, W-PWM	00h
11h	Status-2	Data register containing the status of transmission.	R-M, W-PWM	00h
12h	Temperature Zone	Data register showing temperature zone that have been entered.	R-M, W-PWM	00h
15h	Output_Current	Data register showing direct ADC conversion of averaged output current.	R-M, W-PWM	00h
1Ch	Status_2_lastread	The register contains a copy of the status_2.	R-M, W-PWM	00h
21h	ICC_Max	Data register containing the maximum ICC of platform supports. Binary format in Amp, IE 64h = 100A.	RO, Platform	--
22h	Temp_Max	Data register containing the temperature max the platform supports. Binary format in °C, IE 64h = 100°C Only for CORE VR	RO, Platform	--
24h	SR-Fast	Data register containing the capability of fast slew rate the platform can sustains. Binary format in mV/μs, IE 0Ah = 10mV/μs.	RO	0Ah
25h	SR-Slow	Data register containing the capability of slow slew rate. Binary format in mV/μs IE 02h = 2.5mV/μs.	RO	02h
30h	VOUT_Max	The register is programmed by the master and sets the maximum VID.	RW, Master	BFh
31h	VID Setting	Data register containing currently programmed VID.	RW, Master	00h
32h	Power State	Register containing the current programmed power state.	RW, Master	00h
33h	Offset	Set offset in VID steps.	RW, Master	00h
34h	Multi VR Config	Bit mapped data register which configures multiple VRs behavior on the same bus.	RW, Master	00h
35h	Pointer	Scratch pad register for temporary storage of the SetRegADR pointer register.	RW, Master	30h

Notes :

RO = Read Only

RW = Read/Write

R-M = Read by Master

W-PWM = Write by PWM only

Vendor = hard coded by VR vendor

Platform = programmed by platform

Master = programmed by the master

PWM = programmed by the VR control IC

**Power Ready Detection and Power On Reset (POR)**

During start-up, the RT8167B detects the voltage on the voltage input pins : VCC and EN. When  $V_{CC} > V_{UVLO}$ , the RT8167B will recognize the power state of system to be ready (POR = high) and wait for enable command at EN pin. After POR = high and  $EN > V_{ENTH}$ , the RT8167B will enter start-up sequence for both CORE VR and GFX VR. If the voltage on any voltage pin drops below POR threshold (POR = low), the RT8167B will enter power down sequence and all the functions will be disabled. SVID will be invalid within 300µs after chip becomes enabled. All the protection latches (OVP, OCP, UVP, OTP) will be cleared only after POR = low. EN = low will not clear these latches.

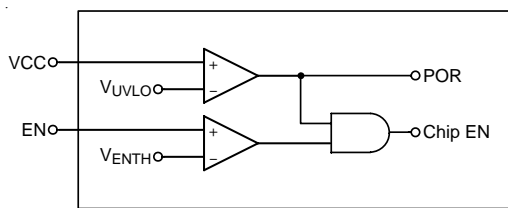

Figure 3. Power Ready Detection and Power On Reset (POR)

**Precise Reference Current Generation**

The RT8167B includes extensive analog circuits inside the controller. These analog circuits need very precise reference voltage/current to drive these analog devices. The RT8167B will auto-generate a 2.14V voltage source at IBIAS pin, and a 53.6kΩ resistor is required to be connected between IBIAS and analog ground. Through this connection, the RT8167B generates a 40µA current from IBIAS pin to analog ground and this 40µA current will be mirrored inside the RT8167B for internal use. Other types of connection or other values of resistance applied at the IBIAS pin may cause failure of the RT8167B's analog circuits. Thus a 53.6kΩ resistor is the only recommended component to be connected to the IBIAS pin. The resistance accuracy of this resistor is recommended to be at least 1%.

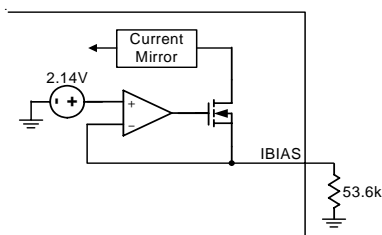

Figure 4. IBIAS Setting

**ICCMAX, ICCMAXA and TMPMAX**

The RT8167B provides ICCMAX, ICCMAXA and TMPMAX pins for platform users to set the maximum level of output current or VR temperature: ICCMAX for CORE VR maximum current, ICCMAXA for GFX VR maximum current, and TMPMAX for CORE VR maximum temperature.

To set ICCMAX, ICCMAXA and TMPMAX, platform designers should use resistive voltage dividers on these three pins. The current of the divider should be several milli-Amps to avoid noise effect. The three items share the same algorithms : the ADC divides 5V into 255 levels. Therefore,  $LSB = 5/255 = 19.6mV$ , which means 19.6mV applied to ICCMAX pin equals to 1A setting. For example, if a platform designer wants to set TMPMAX to 120°C, the voltage applied to TMPMAX should be  $120 \times 19.6mV = 2.352V$ . The ADC circuit inside these three pins will decode the voltage applied and store the maximum current/temperature setting into ICC\_MAX and Temp\_Max registers. The ADC monitors and decodes the voltage at these three pins only after EN = high. If EN = low, the RT8167B will not take any action even when the VR output current or temperature exceeds its maximum setting at these ADC pins. The maximum level settings at these ADC pins are different from over current protection or over temperature protection. That means, these maximum level setting pins are only for platform users to define their system operating conditions and these messages will only be utilized by the CPU.

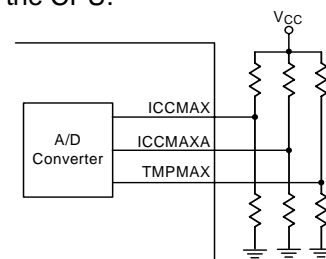

Figure 5. ADC Pins Setting

**V<sub>INI\_CORE</sub> and V<sub>INI\_GFX</sub> Setting**

The initial start up voltage (V<sub>INI\_CORE</sub>, V<sub>INI\_GFX</sub>) of the RT8167B can be set by platform users through SETINI and SETINIA pins. Voltage divider circuit is recommended to be applied to SETINI and SETINIA pins. The V<sub>INI\_CORE</sub>/V<sub>INI\_GFX</sub> relate to SETINI/SETINIA pin voltage setting as shown in Figure 6. Recommended voltage setting at SETINI and SETINIA pins are also shown in Figure 6.

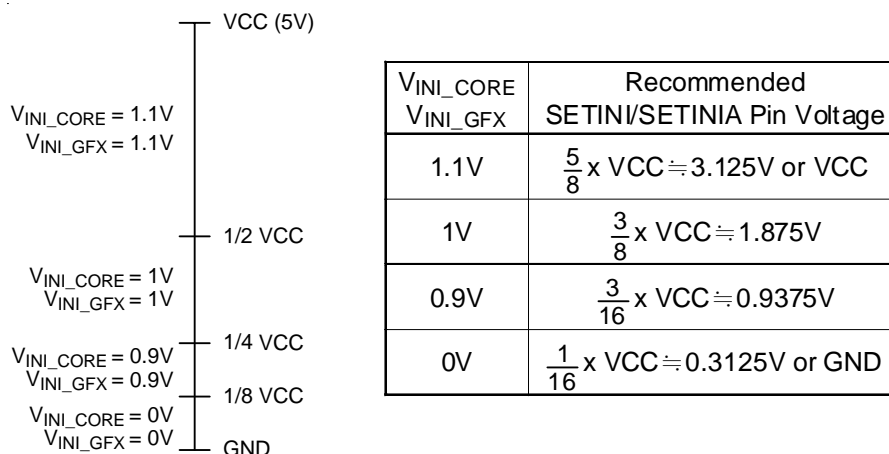

Figure 6. SETINI and SETINIA Pin Voltage Setting

**Start Up Sequence**

The RT8167B utilizes internal soft-start sequence which strictly follows Intel VR12/IMVP7 start up sequence specifications. After POR = high and EN = high, a 300μs delay is needed for the controller to determine whether all the power inputs are ready for entering start up sequence. If pin voltage of SETINI/SETINIA is zero, the output voltage of CORE/GFX VR is programmed to stay at 0V. If pin voltage of SETINI/SETINIA is not zero, VR output voltage will ramp up to initial boot voltage ( $V_{INI\_CORE}$ ,  $V_{INI\_GFX}$ ) after both POR = high and EN = high. After the output voltage of CORE/GFX VR reaches target initial boot voltage, the controller will keep the output voltage at the initial boot voltage and wait for the next SVID commands. After the RT8167B receives valid VID code (typically SetVID\_Slow command), the output voltage will ramp up/down to the target voltage with specified slew rate. After the output voltage reaches the target voltage, the RT8167B will send out VR\_READY signal to indicate the power state of the RT8167B is ready. The VR\_READY circuit is an open-drain structure so a pull-up resistor is recommended for connecting to a voltage source.

**Power Down Sequence**

Similar to the start up sequence, the RT8167B also utilizes a soft shutdown mechanism during turn-off. After POR = low, the internal reference voltage (positive terminal of compensation EA) starts ramping down with 3.125mV/μs slew rate, and output voltage will follow the reference voltage to 0V. After output voltage drops below 0.2V, the RT8167B shuts down and all functions are disabled. The VR\_READY will be pulled down immediately after POR = low.

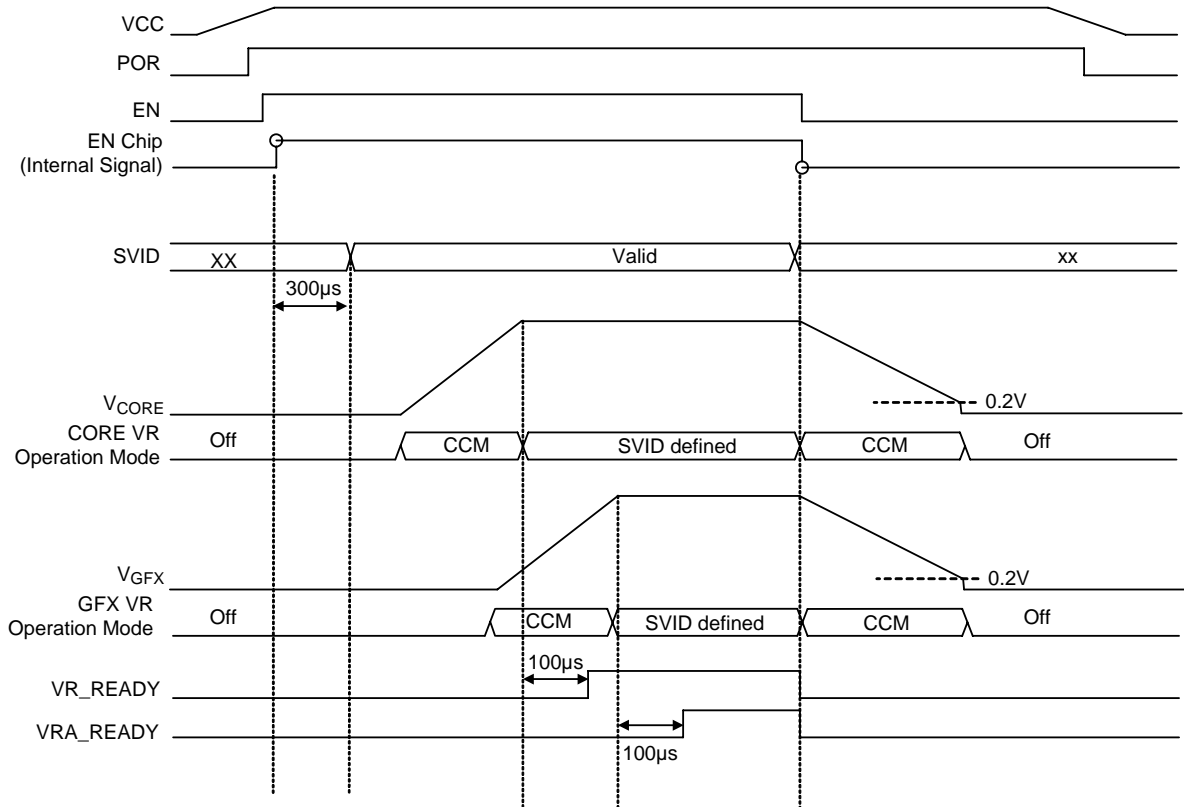

Figure 7 (a). Power sequence for RT8167B ( $V_{INL\_CORE} = V_{INL\_GFX} = 0V$ )

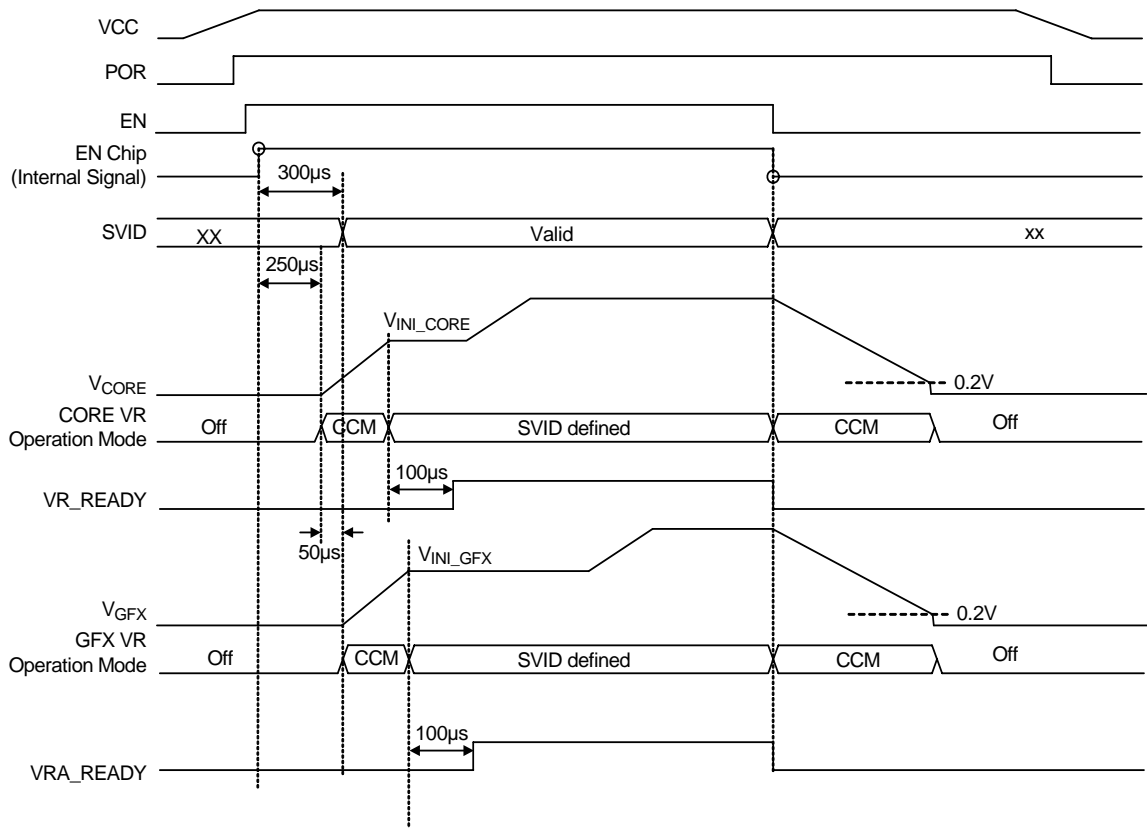

Figure 7 (b). Power sequence for RT8167B ( $V_{INL\_CORE} \neq 0$ ,  $V_{INL\_GFX} \neq 0V$ )

**Disable GFX VR : Before EN = High**

GFX VR enable or disable is determined by the internal circuitry that monitors the ISENAN voltage during start up. Before EN= high, GFX VR detects whether the voltage of ISENAN is higher than “VCC – 1V” to disable GFX VR. The unused driver pins can be connected to GND or left floating.

**GFX VR Forced-DEM Function Enable : After VRA\_Ready = High**

The GFX VR's forced-DEM function can be enabled or disabled with GFXPS2 pin. The RT8167B detects the voltage of GFXPS2 for forced-DEM function. If the voltage at GFXPS2 pin is higher than 4.3V, the GFX VR operates in forced-DEM. If this voltage is lower than 0.7V, the GFX VR follows SVID power state command.

**Loop Control**

Both CORE and GFX VR adopt Richtek's proprietary G-NAVP™ topology. G-NAVP™ is based on the finite-gain valley current mode with CCRCOT (Constant Current Ripple Constant On Time) topology. The output voltage, V<sub>CORE</sub> or V<sub>GFX</sub>, will decrease with increasing output load current. The control loop consists of PWM modulator with power stage, current sense amplifier and error amplifier as shown in Figure 8.

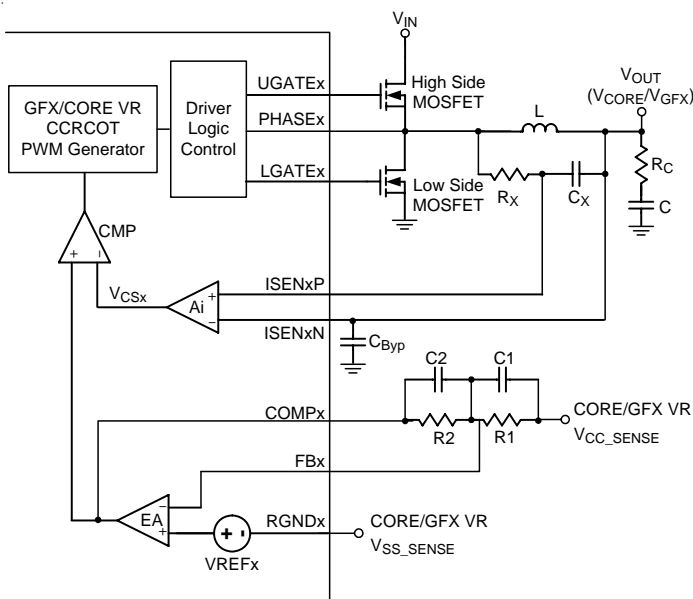

Figure 8. Simplified Schematic for Droop and Remote Sense in CCM

Similar to the valley current mode control with finite compensator gain, the high side MOSFET on-time is determined by the CCRCOT PWM generator. When load current increases, V<sub>CS</sub> increases, the steady state COMP voltage also increases which makes the output voltage decrease, thus achieving AVP.

**Droop Setting (with Temperature Compensation)**

It's very easy to achieve the Active Voltage Positioning (AVP) by properly setting the error amplifier gain due to the native droop characteristics. The target is to have

$$V_{OUT} = V_{REFx} - I_{LOAD} \times R_{DROOP} \tag{1}$$

Then solving the switching condition V<sub>COMPx</sub> = V<sub>CSx</sub> in Figure 8 yields the desired error amplifier gain as

$$A_V = \frac{R_2}{R_1} = \frac{A_i \times R_{SENSE}}{R_{DROOP}} \tag{2}$$

where A<sub>i</sub> is the internal current sense amplifier gain and R<sub>SENSE</sub> is the current sense resistance. If no external sense resistor is present, the DCR of the inductor will act as R<sub>SENSE</sub>. R<sub>DROOP</sub> is the resistive slope value of the converter output and is the desired static output impedance.

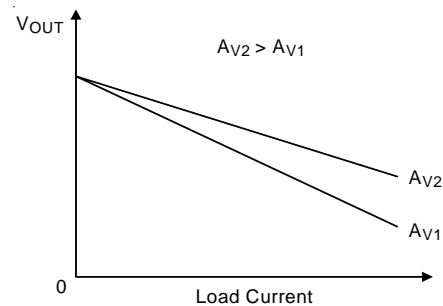

Figure 9. Error Amplifier Gain (A<sub>v</sub>) Influence on V<sub>OUT</sub> Accuracy

Since the DCR of inductor is temperature dependent, it affects the output accuracy in high temperature conditions. Temperature compensation is recommended for the lossless inductor DCR current sense method. Figure 10 shows a simple but effective way of compensating the temperature variations of the sense resistor using an NTC thermistor placed in the feedback path.

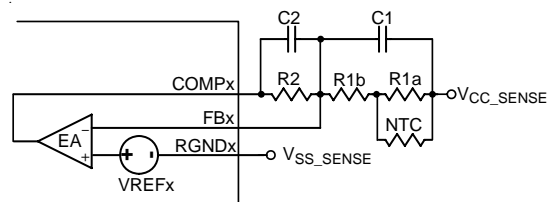

Figure 10. Loop Setting with Temperature Compensation



Usually, R1a is set to equal R<sub>NTC</sub> (25°C), while R1b is selected to linearize the NTC's temperature characteristic. For a given NTC, the design would be to obtain R1b and R2 and then C1 and C2. According to (2), to compensate the temperature variations of the sense resistor, the error amplifier gain (A<sub>V</sub>) should have the same temperature coefficient with R<sub>SENSE</sub>. Hence

$$\frac{A_{V, HOT}}{A_{V, COLD}} = \frac{R_{SENSE, HOT}}{R_{SENSE, COLD}} \quad (3)$$

From (2), we can have A<sub>V</sub> at any temperature (T) as

$$A_{V, T} = \frac{R2}{R1a // R_{NTC, T} + R1b} \quad (4)$$

The standard formula for the resistance of NTC thermistor as a function of temperature is given by :

$$R_{NTC, T} = R_{NTC, 25} e^{\left\{ \beta \left[ \left( \frac{1}{T+273} \right) - \left( \frac{1}{298} \right) \right] \right\}} \quad (5)$$

where R<sub>NTC, 25</sub> is the thermistor's nominal resistance at room temperature, β (beta) is the thermistor's material constant in Kelvins, and T is the thermistor's actual temperature in Celsius.

The DCR value at different temperatures can be calculated using the equation below :

$$DCR_T = DCR_{25} \times [1 + 0.00393 \times (T - 25)] \quad (6)$$

where 0.00393 is the temperature coefficient of copper. For a given NTC thermistor, solving (4) at room temperature (25°C) yields

$$R2 = A_{V, 25} \times (R1b + R1a // R_{NTC, 25}) \quad (7)$$

where A<sub>V, 25°C</sub> is the error amplifier gain at room temperature obtained from (2). R1b can be obtained by substituting (7) to (3),

$$R1b = \frac{\frac{R_{SENSE, HOT}}{R_{SENSE, COLD}} \times (R1a // R_{NTC, HOT}) - (R1a // R_{NTC, COLD})}{\left( 1 - \frac{R_{SENSE, HOT}}{R_{SENSE, COLD}} \right)} \quad (8)$$

## Loop Compensation

Optimized compensation of the CORE VR allows for best possible load step response of the regulator's output. A type-I compensator with one pole and one zero is adequate for a proper compensation. Figure 10 shows the compensation circuit. It was previously mentioned that to determine the resistive feedback components of error amplifier gain, C1 and C2 must be calculated for the compensation. The target is to achieve constant resistive output impedance over the widest possible frequency range.

The pole frequency of the compensator must be set to compensate the output capacitor ESR zero :

$$f_p = \frac{1}{2 \times \pi \times C \times R_C} \quad (9)$$

where C is the capacitance of the output capacitor and R<sub>C</sub> is the ESR of the output capacitor. C2 can be calculated as follows :

$$C2 = \frac{C \times R_C}{R2} \quad (10)$$

The zero of compensator has to be placed at half of the switching frequency to filter the switching-related noise. Such that,

$$C1 = \frac{1}{(R1b + R1a // R_{NTC, 25^\circ C}) \times \pi \times f_{SW}} \quad (11)$$

## TON Setting

High frequency operation optimizes the application by trading off efficiency due to higher switching losses with smaller component size. This may be acceptable in ultra-portable devices where the load currents are lower and the controller is powered from a lower voltage supply. Low frequency operation offers the best overall efficiency at the expense of component size and board space. Figure 11 shows the on-time setting circuit. Connect a resistor (R<sub>TONSETx</sub>) between V<sub>IN</sub> and TONSETx to set the on-time of UGATE<sub>x</sub> :

$$t_{ONx} (V_{REFx} < 1.2V) = \frac{28 \times 10^{-12} \times R_{TONSETx}}{V_{IN} - V_{REFx}} \quad (12)$$

where t<sub>ONx</sub> is the UGATE<sub>x</sub> turn on period, V<sub>IN</sub> is the input voltage of converter, and V<sub>REFx</sub> is the internal reference voltage.



When  $V_{REFx}$  is larger than 1.2V, the equivalent switching frequency may be over the maximum design range, making it unacceptable. Therefore, the VR implements a pseudo-constant-frequency technology to avoid this disadvantage of CCRCOT topology. When  $V_{REFx}$  is larger than 1.2V, the on-time equation will be modified to :

$$t_{ONx} (V_{REFx} \geq 1.2V) = \frac{23.33 \times 10^{-12} \times R_{TONSETx} \times V_{REFx}}{V_{IN} - V_{REFx}} \quad (13)$$

On-time translates roughly to switching frequencies. The on-times guaranteed in the Electrical Characteristics are influenced by switching delays in external high side MOSFET. Also, the dead-time effect increases the effective on-time, reducing the switching frequency. It occurs only in CCM during dynamic output voltage transitions when the inductor current reverses at light or negative load currents. With reversed inductor current, PHASEx goes high earlier than normal, extending the on-time by a period equal to the high side MOSFET rising dead time.

For better efficiency of the given load range, the maximum switching frequency is suggested to be :

$$f_{S(MAX)}(kHz) = \frac{1}{t_{ON} - t_{HS-Delay}} \times \frac{V_{REFx(MAX)} + I_{LOAD(MAX)} \times [R_{ON\_LS-FET} + DCR - R_{DROOP}]}{V_{IN(MAX)} + I_{LOAD(MAX)} \times [R_{ON\_LS-FET} - R_{ON\_HS-FET}]} \quad (14)$$

where  $f_{S(MAX)}$  is the maximum switching frequency,  $t_{HS-Delay}$  is the turn on delay of high side MOSFET,  $V_{REFx(MAX)}$  is the maximum application DAC voltage of application,  $V_{IN(MAX)}$  is the maximum application input voltage,  $I_{LOAD(MAX)}$  is the maximum load of application,  $R_{ON\_LS-FET}$  is the low side MOSFET  $R_{DS(ON)}$ ,  $R_{ON\_HS-FET}$  is the high side MOSFET  $R_{DS(ON)}$ ,  $DCR_L$  is the inductor DCR, and  $R_{DROOP}$  is the load line setting.

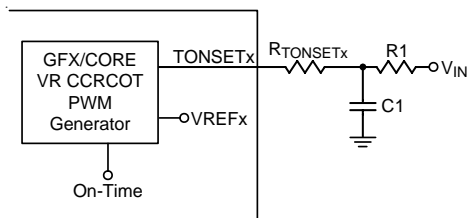

Figure 11. On-Time Setting with RC Filter

### Differential Remote Sense Setting

The CORE/GFX VR includes differential, remote-sense inputs to eliminate the effects of voltage drops along the PC board traces, CPU internal power routes and socket contacts. The CPU contains on-die sense pins CORE/GFX  $V_{CC\_SENSE}$  and  $V_{SS\_SENSE}$ . Connect  $RGNDx$  to CORE/GFX  $V_{SS\_SENSE}$ . Connect  $FBx$  to CORE/GFX  $V_{CC\_SENSE}$  with a resistor to build the negative input path of the error amplifier. The precision voltage reference  $V_{REFx}$  is referred to  $RGND$  for accurate remote sensing.

### Current Sense Setting

The current sense topology of the CORE/GFX VR is continuous inductor current sensing. Therefore, the controller can be less noise sensitive. Low offset amplifiers are used for loop control and over current detection. The internal current sense amplifier gain ( $A_I$ ) is fixed to be 10. The  $ISENxP$  and  $ISENxN$  denote the positive and negative input of the current sense amplifier.

Users can either use a current sense resistor or the inductor's DCR for current sensing. Using inductor's DCR allows higher efficiency as shown in Figure 12. To let

$$\frac{L}{DCR} = R_X \times C_X \quad (15)$$

then the transient performance will be optimum. For example, choose  $L = 0.36\mu H$  with  $1m\Omega$  DCR and  $C_X = 100nF$ , to yields for  $R_X$  :

$$R_X = \frac{0.36\mu H}{1m\Omega \times 100nF} = 3.6k\Omega \quad (16)$$

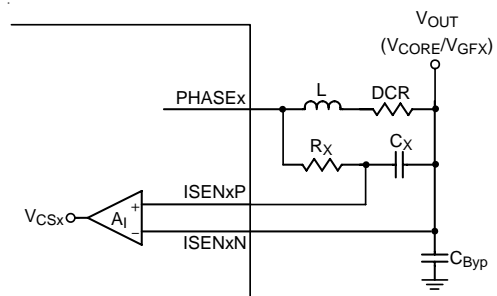

Figure 12. Lossless Inductor Sensing

Considering the inductance tolerance, the resistor  $R_X$  has to be tuned on board by examining the transient voltage. If the output voltage transient has an initial dip below the minimum load line requirement with a slow recovery,  $R_X$  is too small. Vice versa, if the resistance is too large the output voltage transient will only have a small initial dip and the recovery will be too fast, causing a ring-back.

Using current-sense resistor in series with the inductor can have better accuracy, but the efficiency is a trade-off. Considering the equivalent inductance ( $L_{ESL}$ ) of the current sense resistor, a RC filter is recommended. The RC filter calculation method is similar to the above-mentioned inductor DCR sensing method.

### Operation Mode Transition

The RT8167B supports operation mode transition function in CORE/GFX VR for the SetPS command of Intel's VR12/IMVP7 CPU. The default operation mode of the RT8167B's CORE/GFX VR is PS0, which is CCM operation. The other operation mode is PS2 (DEM operation).

After receiving SetPS command, the CORE/GFX VR will immediately change to the new operation state. When VR receives SetPS command of PS2 operation mode, the VR operates as a DEM controller.

If VR receives dynamic VID change command (SetVID), VR will automatically enter PS0 operation mode. After output voltage reaches target voltage, VR will stay at PS0 state and ignore former SetPS command. Only by re-sending SetPS command after SetVID command will VR be forced into PS2 operation state again.

### Thermal Monitoring and Temperature Reporting

CORE/GFX VR provides thermal monitoring function via sensing TSEN pin voltage. Through the voltage divider resistors  $R_1$ ,  $R_2$ ,  $R_3$  and  $R_{NTC}$ , the voltage of TSEN will be proportional to VR temperature. When VR temperature rises, the TSENx voltage also rises. The ADC circuit of VR monitors the voltage variation at TSENx pin from 1.47V to 1.89V with 55mV resolution, and this voltage is decoded into digital format and stored into the Temperature Zone register.

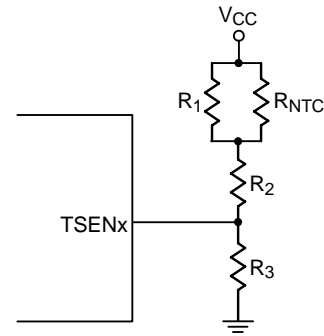

Figure 13. Thermal Monitoring Circuit

To meet Intel's VR12/IMVP7 specification, platform users have to set the TSEN voltage to meet the temperature variation of VR from 75% to 100% VR max temperature. For example, if the VR max temperature is 100°C, platform users have to set the TSEN voltage to be 1.4875V when VR temperature reaches 75°C and 1.8725V when VR temperature reaches 100°C. Detailed voltage setting versus temperature variation is shown in Table 2. Thermometer code is implemented in the Temperature Zone register.

Table 2. Temperature Zone Register

VRHOT	SVID Thermal Alert	Comparator Trip Points					
		Temperatures Scaled to maximum = 100% Voltage Represents Assert bit Minimum Level					
b7	b6	b5	b4	b3	b2	b1	b0
100%	97%	94%	91%	88%	85%	82%	75%
1.855V	1.8V	1.745V	1.69V	1.635V	1.58V	1.525V	1.47V

TSEN Pin Voltage	Temperature_Zone Register Content
$1.855 \leq V_{TSEN}$	1111_1111
$1.800 \leq V_{TSEN} \leq 1.835$	0111_1111
$1.745 \leq V_{TSEN} \leq 1.780$	0011_1111
$1.690 \leq V_{TSEN} \leq 1.725$	0001_1111
$1.635 \leq V_{TSEN} \leq 1.670$	0000_1111
$1.580 \leq V_{TSEN} \leq 1.615$	0000_0111
$1.525 \leq V_{TSEN} \leq 1.560$	0000_0011
$1.470 \leq V_{TSEN} \leq 1.505$	0000_0001
$V_{TSEN} < 1.470$	0000_0000

The RT8167B supports two temperature reporting,  $\overline{VRHOT}$ (hardware reporting) and  $\overline{ALERT}$ (software reporting), to fulfill VR12/IMVP7 specification.  $\overline{VRHOT}$  is an open-drain structure which sends out active-low  $\overline{VRHOT}$  signals. When TSEN voltage rises above 1.855V (100% of VR temperature), the  $\overline{VRHOT}$  signal will be set to low. When TSEN voltage drops below 1.8V (97% of VR temperature), the  $\overline{VRHOT}$  signal will be reset to high. When TSEN voltage rises above 1.8V (97% of VR temperature), The RT8167B will update the bit1 data from 0 to 1 in the Status\_1 register and assert  $\overline{ALERT}$ . When TSEN voltage drops below 1.745V (94% of VR temperature), VR will update the bit1 data from 1 to 0 in the Status\_1 register and assert  $\overline{ALERT}$ .

The temperature reporting function for the GFX VR can be disabled by pulling TSENA pin to VCC in case the temperature reporting function for the GFX VR is not used or the GFX VR is disabled. When the GFX VR's temperature reporting function is disabled, the RT8167B will reject the SVID command of getting the Temperature\_Zone register content of the GFX VR. However, note that the temperature reporting function for the CORE VR is always active. CORE VR's temperature reporting function can not be disabled by pulling TSEN pin to VCC.

**Over Current Protection**

The CORE/GFX VR compares a programmable current limit set point to the voltage from the current sense amplifier output for Over Current Protection (OCP). The voltage applied to OCSETx pin defines the desired peak current limit threshold  $I_{LIMIT}$  :

$$V_{OCSET} = 48 \times I_{LIMIT} \times R_{SENSE} \tag{17}$$

Connect a resistive voltage divider from VCC to GND, with the joint of the resistive divider connected to OCSET pin as shown in Figure 14. For a given  $R_{OC2}$ , then

$$R_{OC1} = R_{OC2} \times \left( \frac{V_{CC}}{V_{OCSET}} - 1 \right) \tag{18}$$

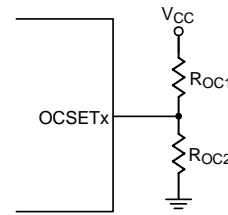

Figure 14. OCP Setting without Temperature Compensation

The current limit is triggered when inductor current exceeds the current limit threshold  $I_{LIMIT}$ , defined by  $V_{OCSET}$ . The driver will be forced to turn off UGATE until the over current condition is cleared. If the over current condition remains valid for 15 PWM cycles, VR will trigger OCP latch. Latched OCP forces both UGATE and LGATE to go low. When OCP is triggered in one of VRs, the other VR will enter into soft shutdown sequence. The OCP latch mechanism will be masked when  $VRx\_READY = low$ , which means that only the current limit will be active when  $V_{OUT}$  is ramping up to initial voltage (or  $V_{REFx}$ ).

If inductor DCR is used as the current sense component, then temperature compensation is recommended for protection under all conditions. Figure 15 shows a typical OCP setting with temperature compensation.

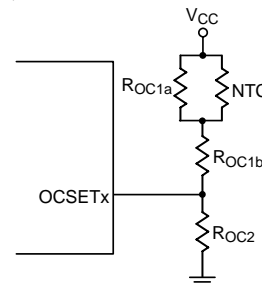

Figure 15. OCP Setting with Temperature Compensation

Usually,  $R_{OC1a}$  is selected to be equal to the thermistor's nominal resistance at room temperature. Ideally,  $V_{OCSET}$  is assumed to have the same temperature coefficient as  $R_{SENSE}$  (Inductor DCR) :

$$\frac{V_{OCSET, HOT}}{V_{OCSET, COLD}} = \frac{R_{SENSE, HOT}}{R_{SENSE, COLD}} \tag{19}$$

According to the basic circuit calculation,  $V_{OCSET}$  can be obtained at any temperature :

$$V_{OCSET, T} = V_{CC} \times \frac{R_{OC2}}{R_{OC1a} // R_{NTC, T} + R_{OC1b} + R_{OC2}} \quad (20)$$

Re-write (19) from (20), to get  $V_{OCSET}$  at room temperature

$$\frac{R_{OC1a} // R_{NTC, COLD} + R_{OC1b} + R_{OC2}}{R_{OC1a} // R_{NTC, HOT} + R_{OC1b} + R_{OC2}} = \frac{R_{SENSE, HOT}}{R_{SENSE, COLD}} \quad (21)$$

$$V_{OCSET, 25} = V_{CC} \times \frac{R_{OC2}}{R_{OC1a} // R_{NTC, 25} + R_{OC1b} + R_{OC2}} \quad (22)$$

Solving (21) and (22) yields  $R_{OC1b}$  and  $R_{OC2}$

$$R_{OC2} = \frac{\alpha \times R_{EQU, HOT} - R_{EQU, COLD} + (1 - \alpha) \times R_{EQU, 25}}{\frac{V_{CC}}{V_{OCSET, 25}} \times (1 - \alpha)} \quad (23)$$

$$R_{OC1b} = \frac{(\alpha - 1) \times R_2 + \alpha \times R_{EQU, HOT} - R_{EQU, COLD}}{(1 - \alpha)} \quad (24)$$

where  
 $\alpha =$

$$\frac{R_{SENSE, HOT}}{R_{SENSE, COLD}} = \frac{DCR_{25} \times [1 + 0.00393 \times (T_{HOT} - 25)]}{DCR_{25} \times [1 + 0.00393 \times (T_{COLD} - 25)]} \quad (25)$$

$$R_{EQU, T} = R_{OC1a} // R_{NTC, T} \quad (26)$$

## Over Voltage Protection (OVP)

The over voltage protection circuit of CORE/GFX VR monitors the output voltage via the ISENxN pin. The supported maximum operating VID of VR ( $V_{(MAX)}$ ) is stored in the Vout\_Max register. Once  $V_{ISENxN}$  exceeds " $V_{(MAX)} + 200mV$ ", OVP is triggered and latched. VR will try to turn on low side MOSFETs and turn off high side MOSFETs to protect CPU. When OVP is triggered by the one of the VRs, the other VR will enter soft shutdown sequence. A 10 $\mu$ s delay is used in OVP detection circuit to prevent false trigger.

## Negative Voltage Protection (NVP)

During OVP latch state, both CORE/GFX VRs also monitor ISENxN pin for negative voltage protection. Since the OVP latch will continuously turn on low side MOSFET of VR, VR may suffer negative output voltage. Therefore, when the voltage of ISENxN drops below  $-0.05V$  after triggering OVP, VR will turn off low side MOSFETs while high side MOSFETs remain off. The NVP function will be active only after OVP is triggered.

## Under Voltage Protection (UVP)

Both CORE/GFX VR implement Under Voltage Protection (UVP). If ISENxN is less than  $V_{REFX}$  by  $300mV + V_{OFFSET}$ , VR will trigger UVP latch. The UVP latch will turn off both high side and low side MOSFETs. When UVP is triggered by one of the VRs, the other VR will enter into soft shutdown sequence. The UVP mechanism is masked when  $VRx\_READY = low$ .

## Under Voltage Lock Out (UVLO)

During normal operation, if the voltage at the VCC pin drops below UVLO falling edge threshold, both VR will trigger UVLO. The UVLO protection forces all high side MOSFETs and low side MOSFETs off to turn off.

## Inductor Selection

The switching frequency and ripple current determine the inductor value as follows :

$$L_{MIN} = \frac{V_{IN} - V_{OUT}}{I_{Ripple(MAX)}} \times t_{ON} \quad (27)$$

where  $t_{ON}$  is the UGATE turn on period.

Higher inductance induces less ripple current and hence higher efficiency. However, the tradeoff is a slower transient response of the power stage to load transients. This might increase the need for more output capacitors, thus driving up the cost. Find a low-loss inductor having the lowest possible DC resistance that fits in the allotted dimensions. The core must be large enough not to be saturated at the peak inductor current.

**Output Capacitor Selection**

Output capacitors are used to obtain high bandwidth for the output voltage beyond the bandwidth of the converter itself. Usually, the CPU manufacturer recommends a capacitor configuration. Two different kinds of output capacitors can be found, bulk capacitors closely located to the inductors and ceramic output capacitors in close proximity to the load. Latter ones are for mid-frequency decoupling with very small ESR and ESL values while the bulk capacitors have to provide enough stored energy to overcome the low-frequency bandwidth gap between the regulator and the CPU.

- ▶ The capacitor connected to the ISEN1N/ISENAN for noise decoupling is optional and it should also be placed close to the ISEN1N/ISENAN pin.
- ▶ The NTC thermistor should be placed physically close to the inductor for better DCR thermal compensation.

**Layout Consideration**

Careful PC board layout is critical to achieving low switching losses and clean, stable operation. The switching power stage requires particular attention. If possible, mount all of the power components on the top side of the board with their ground terminals flushed against one another. Follow these guidelines for optimum PC board layout :

- ▶ Keep the high current paths short, especially at the ground terminals.
- ▶ Keep the power traces and load connections short. This is essential for high efficiency.
- ▶ When trade-offs in trace lengths must be made, it's preferable to allow the inductor charging path to be made longer than the discharging path.
- ▶ Place the current sense component close to the controller. ISENxP and ISENxN connections for current limit and voltage positioning must be made using Kelvin sense connections to guarantee the current sense accuracy. The PCB trace from the sense nodes should be parallel to the controller.
- ▶ Route high-speed switching nodes away from sensitive analog areas (COMPx, FBx, ISENxP, ISENxN, etc...)
- ▶ Special attention should be paid in placing the DCR current sensing components. The DCR current sensing capacitor and resistors must be placed close to the controller.

## Outline Dimension

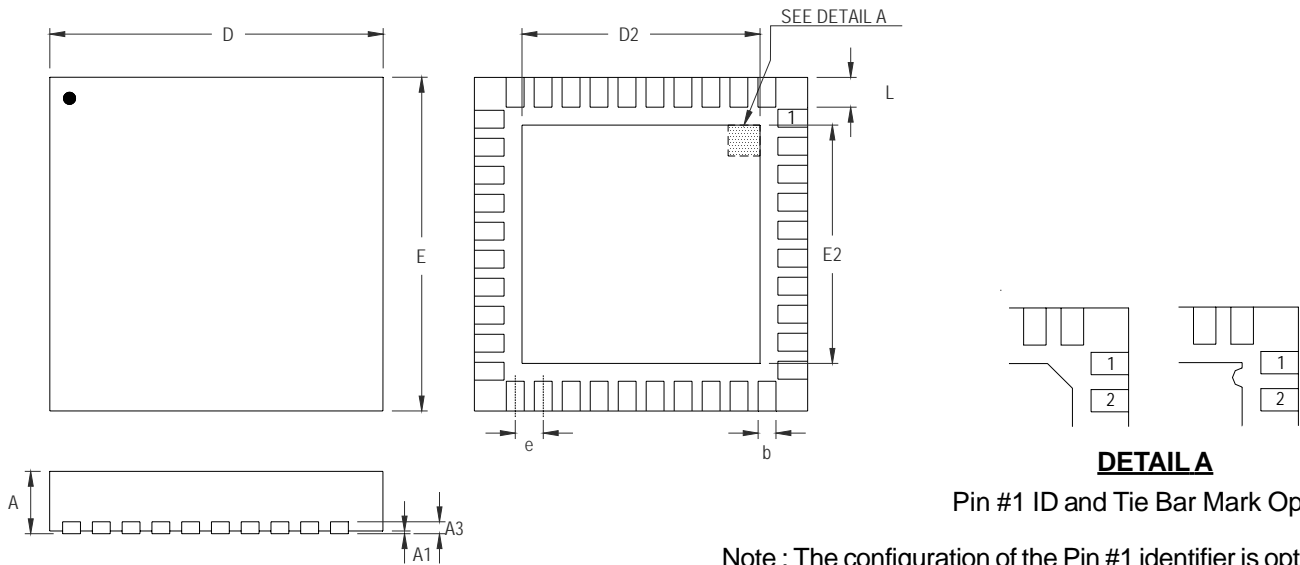

Note : The configuration of the Pin #1 identifier is optional, but must be located within the zone indicated.

Symbol	Dimensions In Millimeters		Dimensions In Inches	
	Min	Max	Min	Max
A	0.700	0.800	0.028	0.031
A1	0.000	0.050	0.000	0.002
A3	0.175	0.250	0.007	0.010
b	0.150	0.250	0.006	0.010
D	4.950	5.050	0.195	0.199
D2	3.250	3.500	0.128	0.138
E	4.950	5.050	0.195	0.199
E2	3.250	3.500	0.128	0.138
e	0.400		0.016	
L	0.350	0.450	0.014	0.018

### W-Type 40L QFN 5x5 Package

#### Richtek Technology Corporation

Headquarter  
5F, No. 20, Taiyuen Street, Chupei City  
Hsinchu, Taiwan, R.O.C.  
Tel: (8863)5526789 Fax: (8863)5526611

#### Richtek Technology Corporation

Taipei Office (Marketing)  
5F, No. 95, Minchiuan Road, Hsintien City  
Taipei County, Taiwan, R.O.C.  
Tel: (8862)86672399 Fax: (8862)86672377  
Email: marketing@richtek.com

Information that is provided by Richtek Technology Corporation is believed to be accurate and reliable. Richtek reserves the right to make any change in circuit design, specification or other related things if necessary without notice at any time. No third party intellectual property infringement of the applications should be guaranteed by users when integrating Richtek products into any application. No legal responsibility for any said applications is assumed by Richtek.