

Vanadium Pentoxide Lithium Coin Batteries (VL Series): Individual Specifications

VL2330

■ Dimensions(mm)

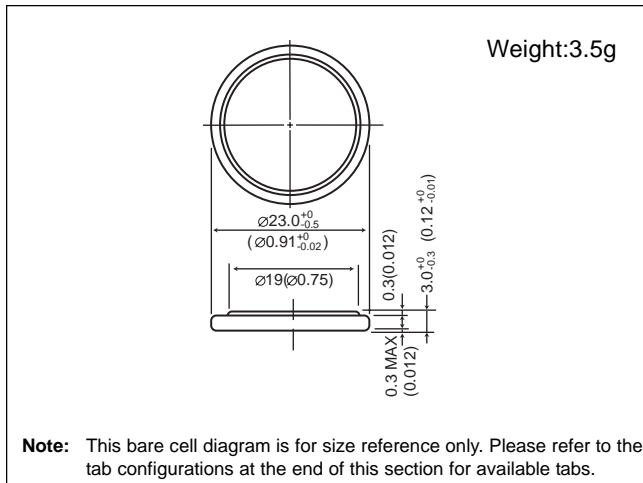

■ Specification

Nominal voltage (V)	3
Nominal capacity (mAh)	50.0
Continuous standard load (mA)	0.1
Operating temperature (C)	-20 ~ +60

■ Discharge Temperature Characteristics

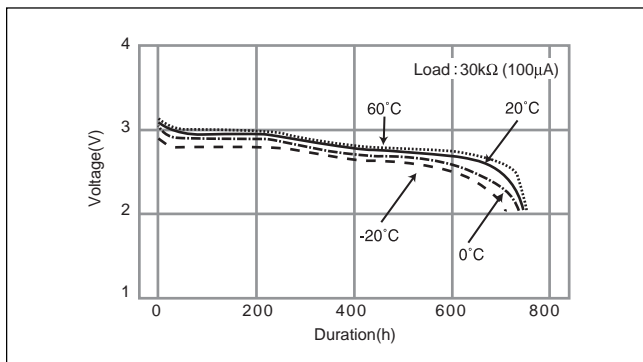

■ Consumption current vs. Duration time

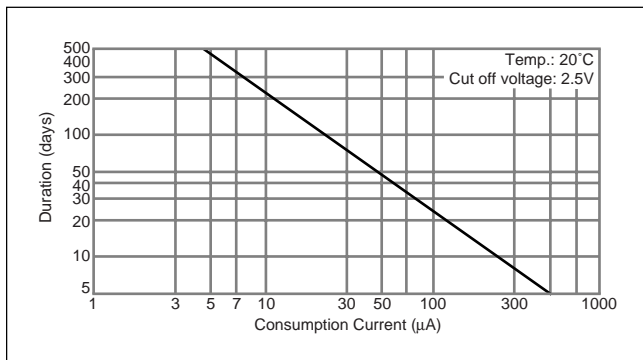

VL3032

■ Dimensions(mm)

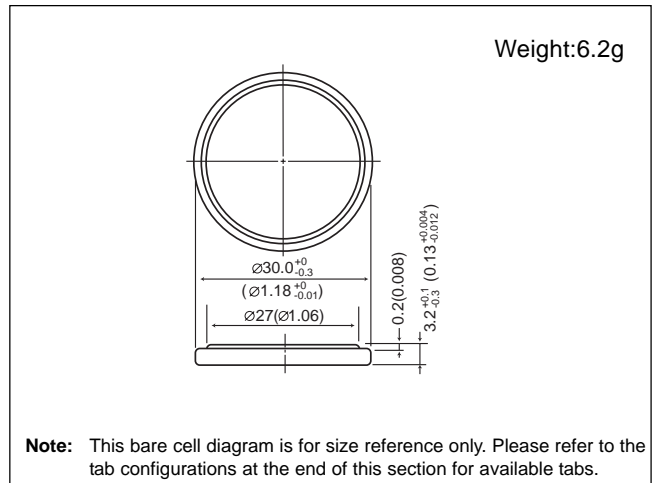

■ Specification

Nominal voltage (V)	3
Nominal capacity (mAh)	100.0
Continuous standard load (mA)	0.2
Operating temperature (C)	-20 ~ +60

■ Discharge Temperature Characteristics

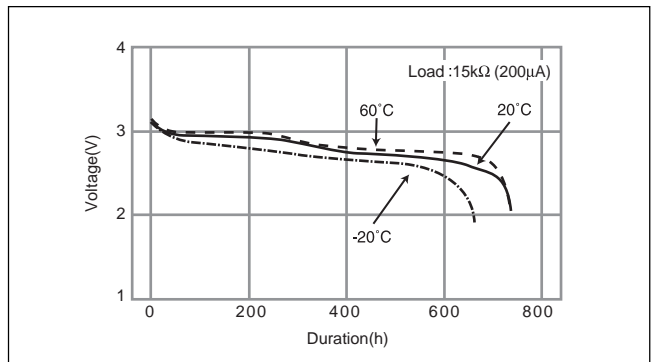

■ Consumption current vs. Duration time

