

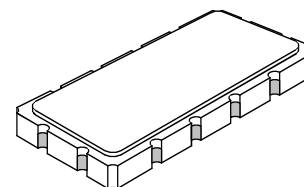

SF2185A-1

70.00 MHz SAW Filter



SM13365-12

- Precision IF SAW Filter
- Balanced 50 ohm Operation
- Hermetic 13.3 x 6.5 mm Surface-mount Case
- Complies with Directive 2002/95/EC (RoHS)



Absolute Maximum Ratings

Rating	Value	Units
Maximum Incident Power in Passband	+10	dBm
Maximum DC Voltage Between any Two Terminals	30	VDC
Storage Temperature Range in Tape and Reel	-40 to +85	°C
Suitable for Lead-free Soldering - Maximum Soldering Profile	260°C for 30 s	

Electrical Characteristics

Characteristic	Sym	Notes	Min	Typ	Max	Units
Center Frequency	F_C	1	69.5	70.0	70.5	MHz
Minimum Insertion Loss	IL_{MIN}	1		10.6	11.0	dB
1 dB Bandwidth	BW_1	1	8.1	10.2		MHz
3 dB Bandwidth	BW_3	1	9.1	10.7		MHz
30 dB Bandwidth	BW_{30}	1		12.35	13.20	MHz
Attenuation Referenced to IL_{MIN} :						
50 to 62.5 MHz		3	38	40		dB
62.5 to 63 MHz		3	34	40		
77 to 77.5 MHz		3	26	33.5		
77.5 to 90 MHz		3	35	38		
Passband Ripple, $F_C \pm 3.0$ MHz		1, 2, 3		0.65	1.0	dB _{p-p}
Phase Ripple, $F_C \pm 4.5$ MHz				12.5	20	deg
Group Delay Ripple, $F_C \pm 4.5$ MHz				170	200	ns _{p-p}
Operating Temperature		1	-20		+80	°C
Balanced Source Impedance				50		ohm
Balanced Load Impedance				50		ohm
Frequency Temperature Coefficient				-94		ppm/°C

Impedance Matching to 50 Ω	External Source/Load L-C Networks
Case Style	SM13365-12 13.3 x 6.5 mm Nominal Footprint
Lid Symbolization (YY = year, WW = week)	RFM SF2185A1 YYWW



CAUTION: Electrostatic Sensitive Device. Observe precautions for handling.

Notes:

1. Unless noted otherwise, all specifications apply over the operating temperature range with filter soldered to the specified demonstration board with impedance matching to 50 Ω and measured with 50 Ω network analyzer.
2. Unless noted otherwise, all frequency specifications are referenced to the nominal center frequency, f_c .
3. Rejection is measured as attenuation below the minimum IL point in the passband. Rejection in final user application is dependent on PCB layout and external impedance matching design. See Application Note No. 42 for details.
4. Part to part absolute delay measurement records the absolute delay mean across 1 dB passband.
5. "LRIP" or "L" after the part number indicates "low rate initial production" and "ENG" or "E" indicates "engineering prototypes."
6. The design, manufacturing process, and specifications of this filter are subject to change.
7. Either Port 1 or Port 2 may be used for either input or output in the design. However, impedances and impedance matching may vary between Port 1 and Port 2, so that the filter must always be installed in one direction per the circuit design.
8. US and international patents may apply.

SF2185A-1 Filter Response

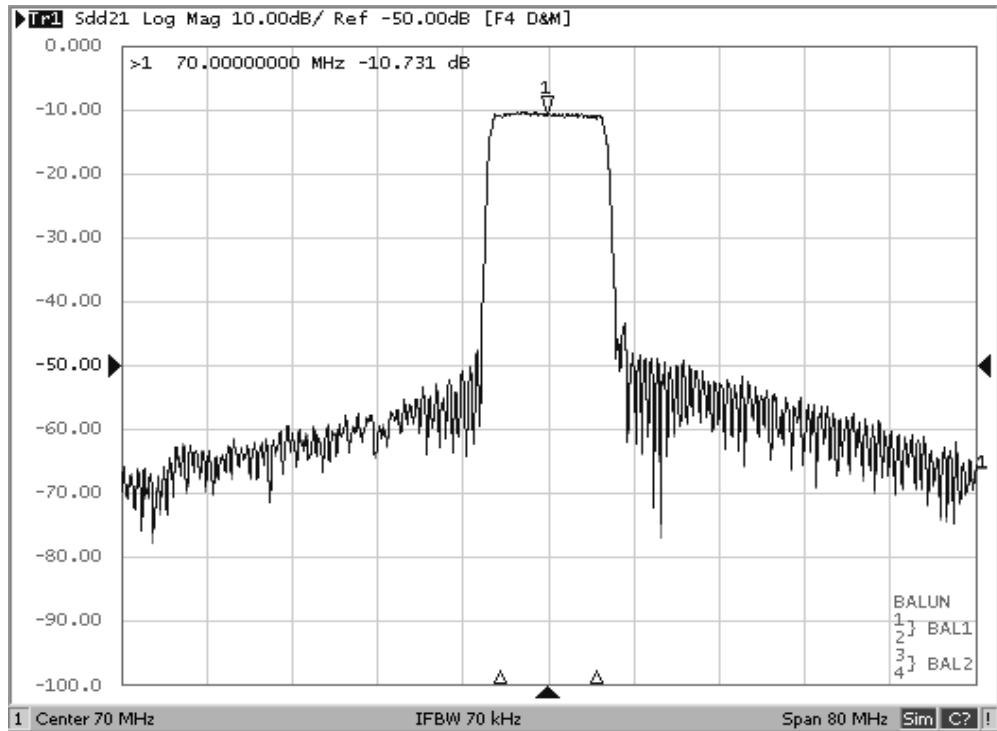

SF2185A-1 Passband Amplitude and Group Delay Ripple

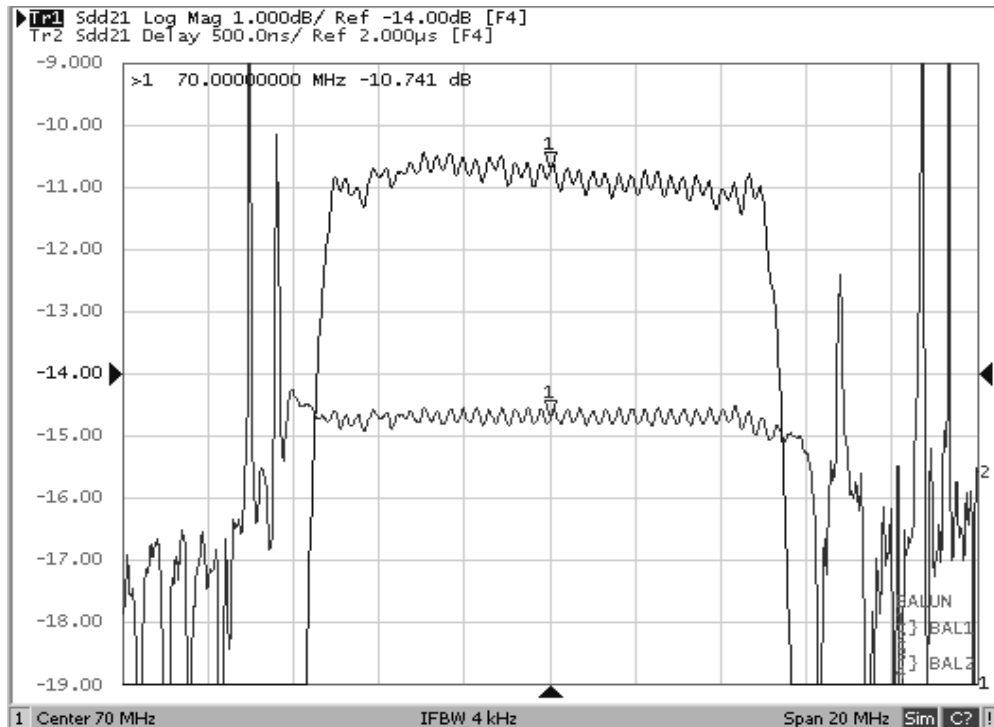

SF2185A-1 Balanced Input Impedance

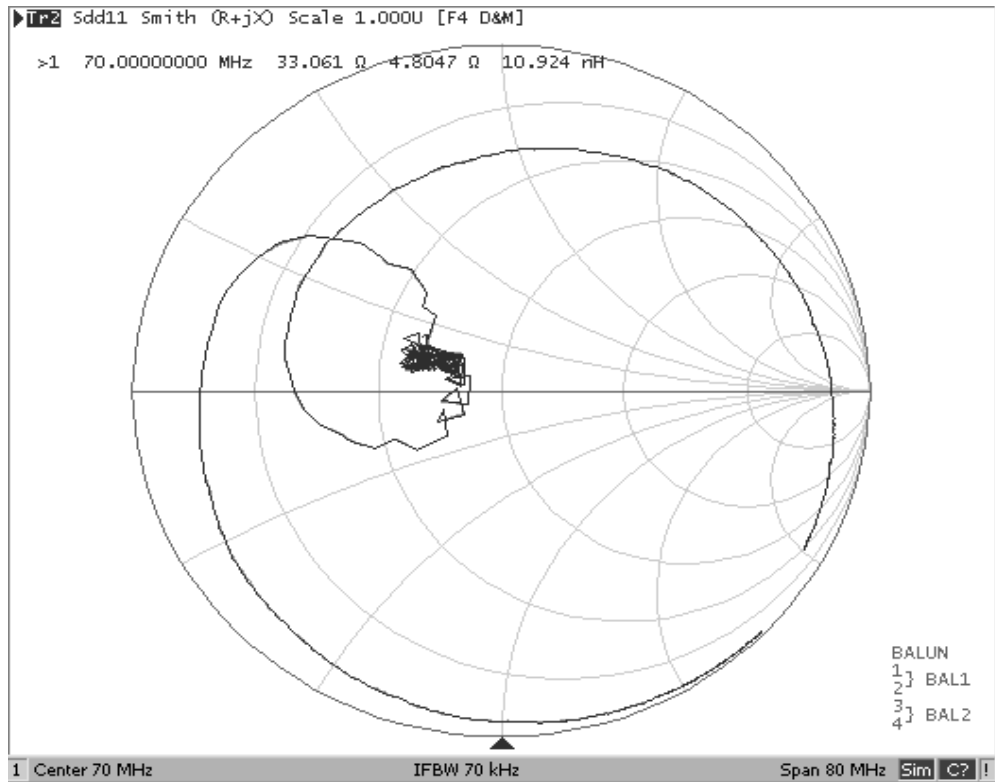

SF2185A-1 Balanced Output Impedance

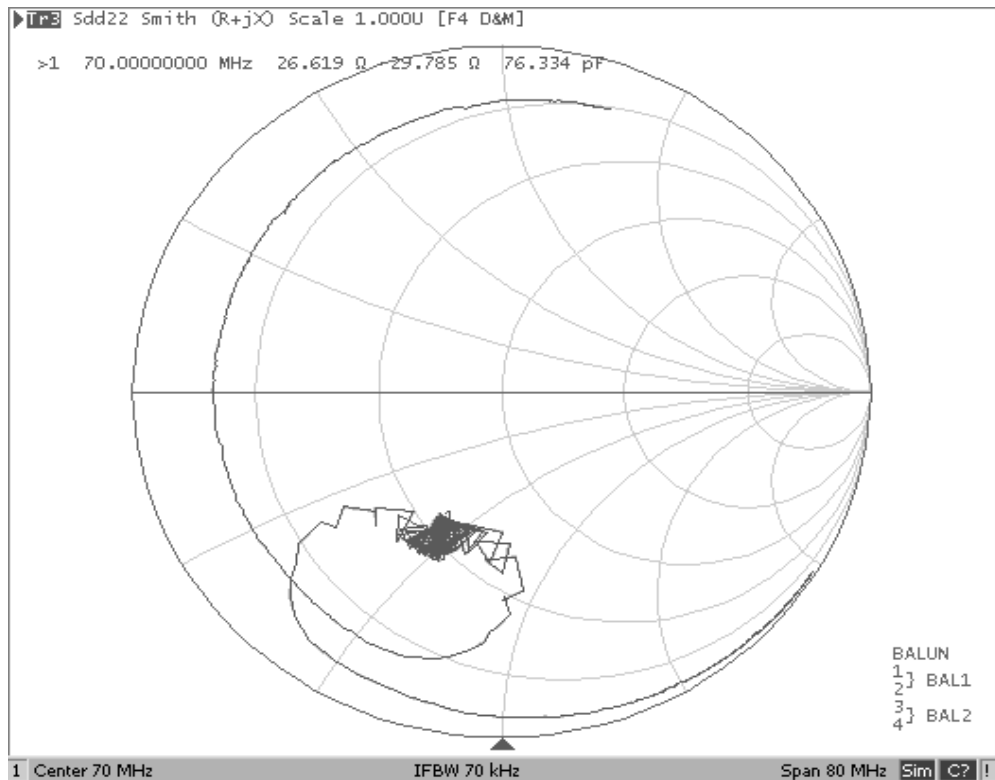

SF2185A-1 Balanced Tuning Component Values

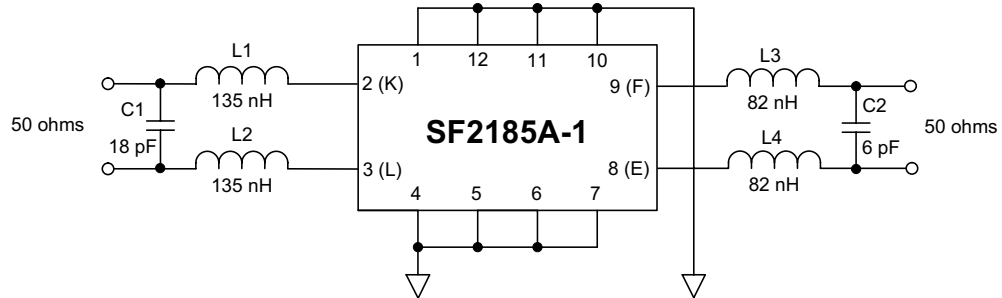

PCB Pad Layout

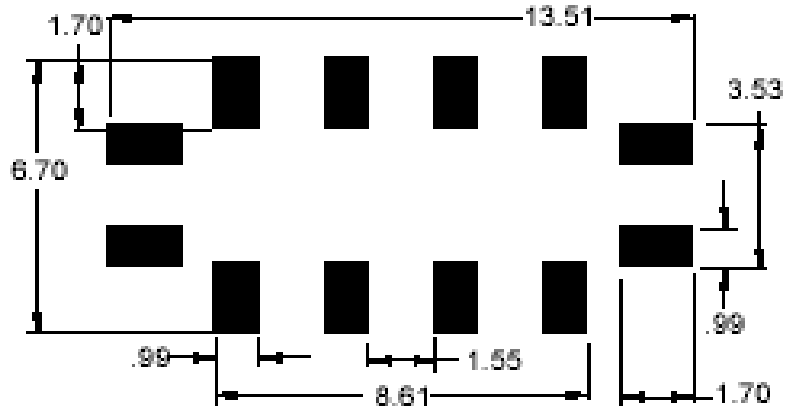

SM13365-12 Case

12-Terminal Ceramic Surface-Mount Case

13.3 x 6.5 mm Nominal Footprint

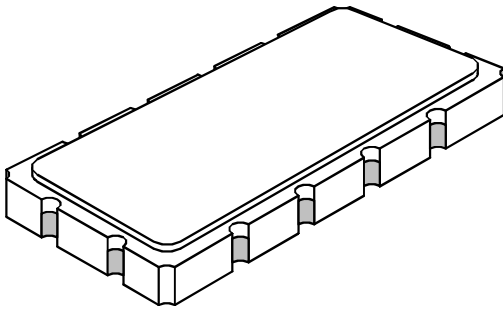

Case Dimensions

Dimension	mm			Inches		
	Min	Nom	Max	Min	Nom	Max
A	13.08	13.31	13.60	0.515	0.524	0.535
B	6.27	6.50	6.80	0.247	0.256	0.268
C		1.91	2.00		0.075	0.079
D		1.50			0.059	
E		0.79			0.031	
H		1.0			0.039	
P		2.54			0.100	

Electrical Connections

Connection	Terminals
Input	K
Output	E
Case Ground	All others

Materials

Solder Pad Plating	0.3 to 1.0 μm Gold over 1.27 to 8.89 μm Nickel
Lid Plating	2.0 to 3.0 μm Nickel
Body	Al_2O_3 Ceramic
Pb Free	

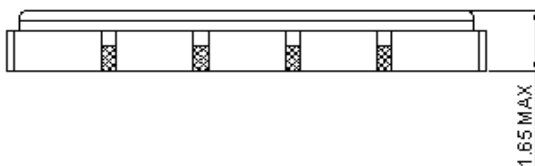
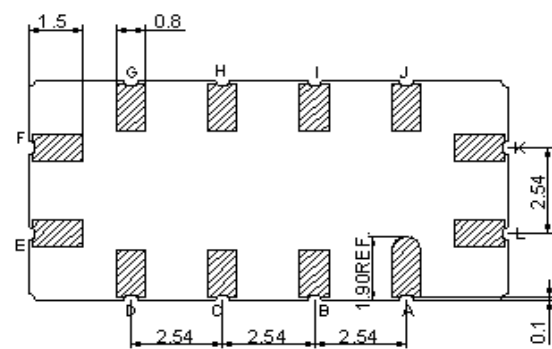

Tape and Reel Details

