

# General Purpose Transistors

www.datasheet4u.com

## PNP Silicon

These transistors are designed for general purpose amplifier applications. They are housed in the SOT-323/SC-70 which is designed for low power surface mount applications.

### Features

We declare that the material of product compliance with RoHS requirements.

### MAXIMUM RATINGS

Rating	Symbol	BC856	BC857	BC858	Unit
Collector-Emitter Voltage	$V_{CEO}$	-65	-45	-30	V
Collector-Base Voltage	$V_{CBO}$	-80	-50	-30	V
Emitter-Base Voltage	$V_{EBO}$	-5.0	-5.0	-5.0	V
Collector Current — Continuous	$I_C$	-100	-100	-100	mAdc

### THERMAL CHARACTERISTICS

Characteristic	Symbol	Max	Unit
Total Device Dissipation FR-5 Board, (1) $T_A = 25^\circ\text{C}$	$P_D$	150	mW
Thermal Resistance, Junction to Ambient	$R_{\theta JA}$	833	$^\circ\text{C/W}$
Junction and Storage Temperature	$T_J, T_{stg}$	-55 to +150	$^\circ\text{C}$

### DEVICE MARKING

LBC856AWT1G= 3A; LBC856BWT1G= 3B; LBC857AWT1G= 3E; LBC857BWT1G = 3F;  
LBC858AWT1G= 3J; LBC858BWT1G= 3K; LBC858CWT1G= 3L

### ELECTRICAL CHARACTERISTICS ( $T_A = 25^\circ\text{C}$ unless otherwise noted.)

Characteristic	Symbol	Min	Typ	Max	Unit
----------------	--------	-----	-----	-----	------

#### OFF CHARACTERISTICS

Collector-Emitter Breakdown Voltage ( $I_C = -10\text{ mA}$ )	LBC856 Series	-65	—	—	
	LBC857 Series	$V_{(BR)CEO}$	-45	—	v
	LBC858 Series	-30	—	—	
Collector-Emitter Breakdown Voltage ( $I_C = -10\ \mu\text{A}, V_{EB} = 0$ )	LBC856 Series	-80	—	—	
	LBC857 Series	$V_{(BR)CES}$	-50	—	v
	LBC858 Series	-30	—	—	
Collector-Base Breakdown Voltage ( $I_C = -10\ \mu\text{A}$ )	LBC856 Series	-80	—	—	
	LBC857 Series	$V_{(BR)CBO}$	-50	—	v
	LBC858 Series	-30	—	—	
Emitter-Base Breakdown Voltage ( $I_E = -1.0\ \mu\text{A}$ )	LBC856 Series	-5.0	—	—	
	LBC857 Series	$V_{(BR)EBO}$	-5.0	—	v
	LBC858 Series	-5.0	—	—	
Collector Cutoff Current ( $V_{CB} = -30\text{ V}$ ) ( $V_{CB} = -30\text{ V}, T_A = 150^\circ\text{C}$ )		$I_{CBO}$	—	-15	nA
			—	-4.0	$\mu\text{A}$

1.FR-5=1.0 x 0.75 x 0.062in

LBC856AWT1G, BWT1G  
LBC857AWT1G, BWT1G  
LBC858AWT1G, BWT1G  
CWT1G

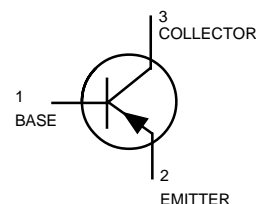
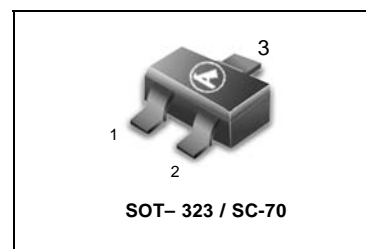

**LBC856AWT1G, BWT1G LBC857AWT1G, BWT1G LBC858AWT1G, BWT1G, CWT1G**

www.datasheet4u.com

**ELECTRICAL CHARACTERISTICS** ( $T_A = 25^\circ\text{C}$  unless otherwise noted) (Continued)

Characteristic	Symbol	Min	Typ	Max	Unit
<b>ON CHARACTERISTICS</b>					
DC Current Gain ( $I_C = -10\ \mu\text{A}$ , $V_{CE} = -5.0\ \text{V}$ )	LBC856A, LBC857A, LBC858A LBC856B, LBC857B, LBC858B LBC858C,	$h_{FE}$	—	90	—
			—	150	—
			—	270	—
( $I_C = -2.0\ \text{mA}$ , $V_{CE} = -5.0\ \text{V}$ )	LBC856A, LBC857A, LBC858A LBC856B, LBC857B, LBC858B LBC858C,		125	180	250
			220	290	475
			420	520	800
Collector–Emitter Saturation Voltage ( $I_C = -10\ \text{mA}$ , $I_B = -0.5\ \text{mA}$ ) ( $I_C = -100\ \text{mA}$ , $I_B = -5.0\ \text{mA}$ )	$V_{CE(sat)}$	—	—	-0.3	V
		—	—	-0.65	
Base–Emitter Saturation Voltage ( $I_C = -10\ \text{mA}$ , $I_B = -0.5\ \text{mA}$ ) ( $I_C = -100\ \text{mA}$ , $I_B = -5.0\ \text{mA}$ )	$V_{BE(sat)}$	—	-0.7	—	V
		—	-0.9	—	
Base–Emitter Voltage ( $I_C = -2.0\ \text{mA}$ , $V_{CE} = -5.0\ \text{V}$ ) ( $I_C = -10\ \text{mA}$ , $V_{CE} = -5.0\ \text{V}$ )	$V_{BE(on)}$	-0.6	—	-0.75	V
		—	—	-0.82	

**SMALL–SIGNAL CHARACTERISTICS**

Current–Gain — Bandwidth Product ( $I_C = -10\ \text{mA}$ , $V_{CE} = -5.0\ \text{Vdc}$ , $f = 100\ \text{MHz}$ )	$f_T$	100	—	—	MHz
Output Capacitance ( $V_{CB} = -10\ \text{V}$ , $f = 1.0\ \text{MHz}$ )	$C_{ob}$	—	—	4.5	pF
Noise Figure ( $I_C = -0.2\ \text{mA}$ , $V_{CE} = -5.0\ \text{Vdc}$ , $R_S = 2.0\ \text{k}\Omega$ , $f = 1.0\ \text{kHz}$ , $BW = 200\ \text{Hz}$ )	NF	—	—	10	dB

**ORDERING INFORMATION** (Pb–Free)

Device	Package	Shipping
LBC856AWT1G_S	SOT-23	3000/Tape & Reel
LBC856AWT3G_S	SOT-23	10000/Tape & Reel

LBC856AWT1G, BWT1G LBC857AWT1G, BWT1G LBC858AWT1G, BWT1G, CWT1G

www.datasheet4u.com

LBC857/LBC858

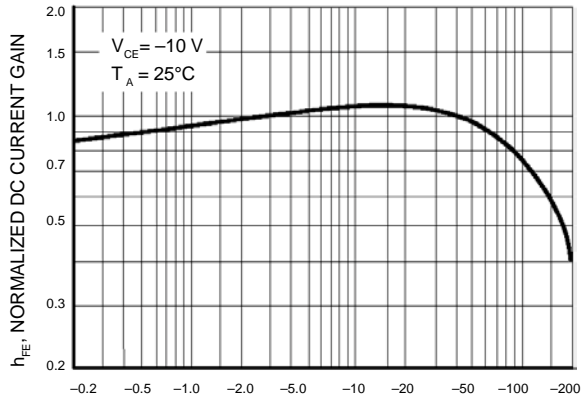

IC, COLLECTOR CURRENT (mAdc)  
Figure 1. Normalized DC Current Gain

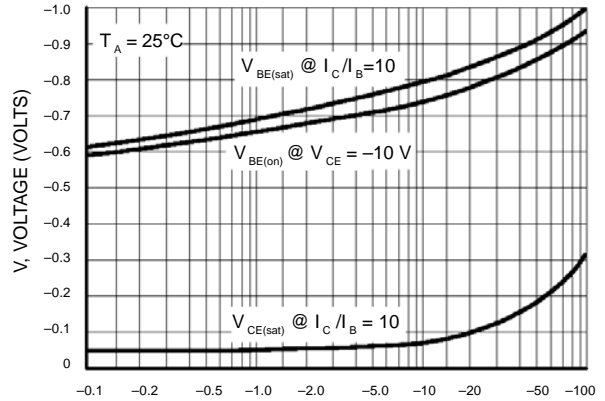

IC, COLLECTOR CURRENT (mAdc)  
Figure 2. "Saturation" and "On" Voltages

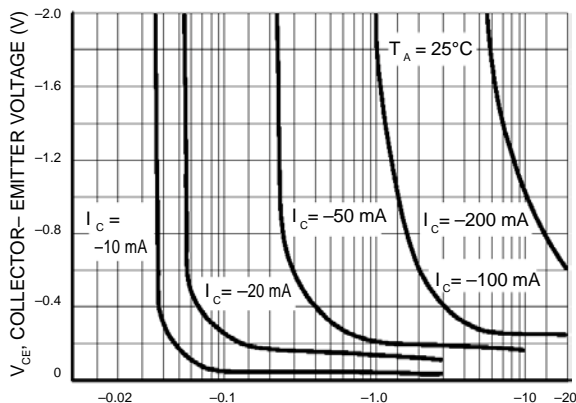

IB, BASE CURRENT (mA)  
Figure 3. Collector Saturation Region

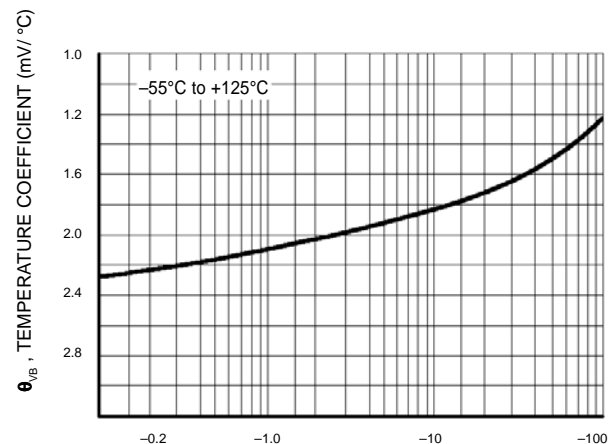

IC, COLLECTOR CURRENT (mA)  
Figure 4. Base-Emitter Temperature Coefficient

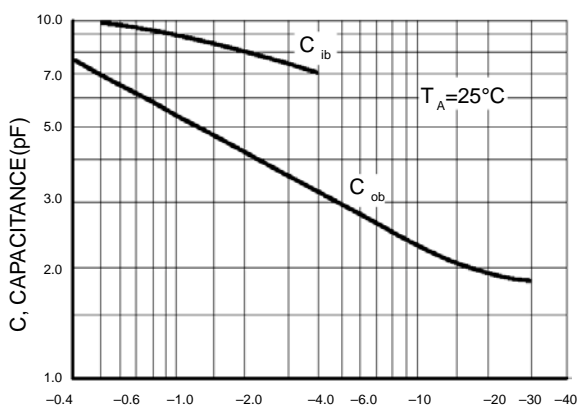

VR, REVERSE VOLTAGE (VOLTS)  
Figure 5. Capacitances

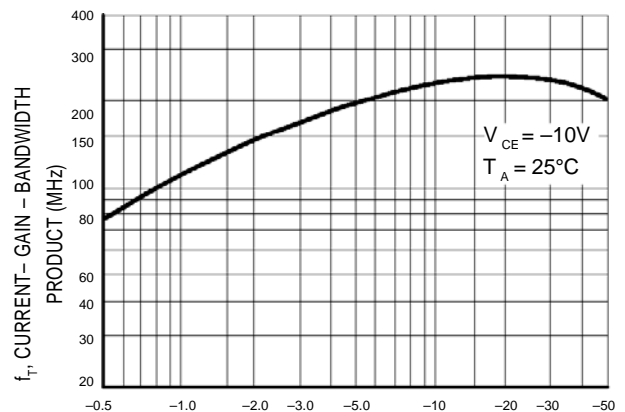

IC, COLLECTOR CURRENT (mAdc)  
Figure 6. Current-Gain - Bandwidth Product

LBC856AWT1G, BWT1G LBC857AWT1G, BWT1G LBC858AWT1G, BWT1G, CWT1G

www.datasheet4u.com

LBC856

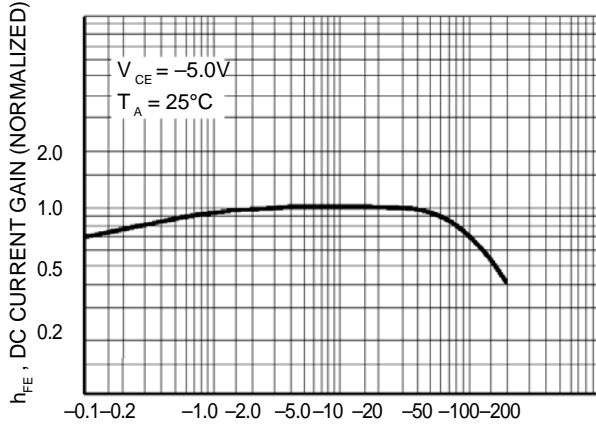

Figure 7. DC Current Gain

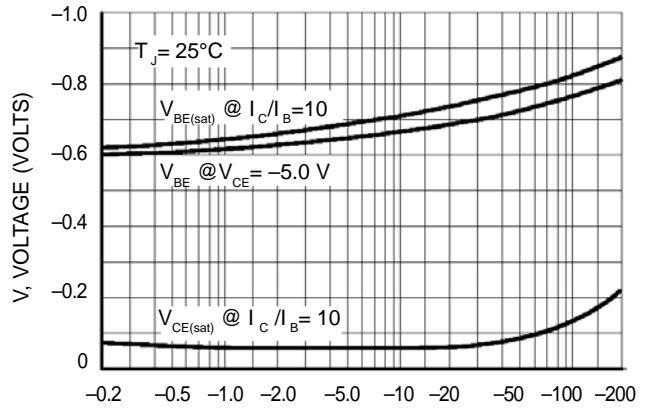

Figure 8. "On" Voltage

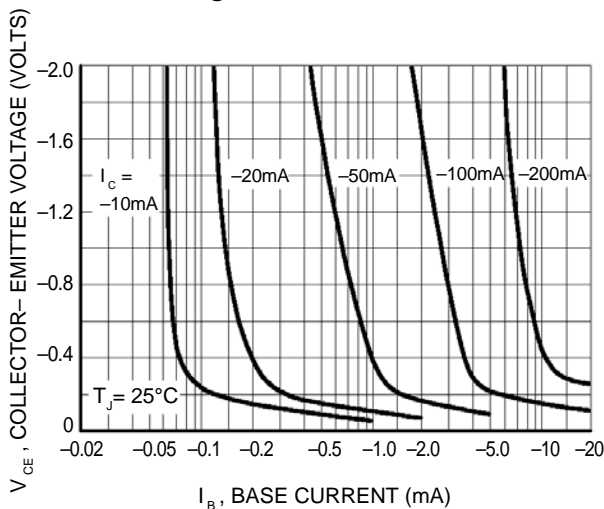

Figure 9. Collector Saturation Region

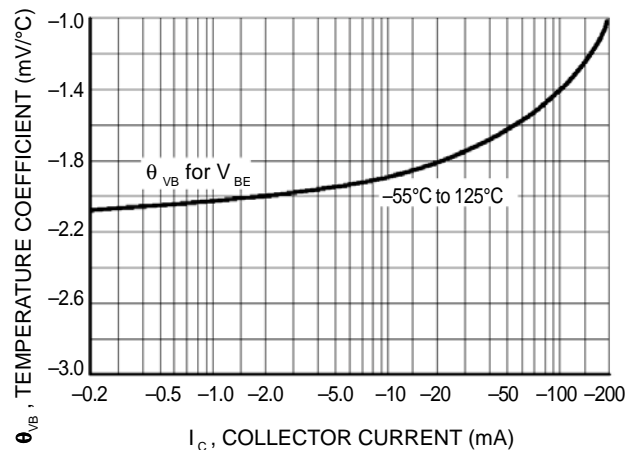

Figure 10. Base-Emitter Temperature Coefficient

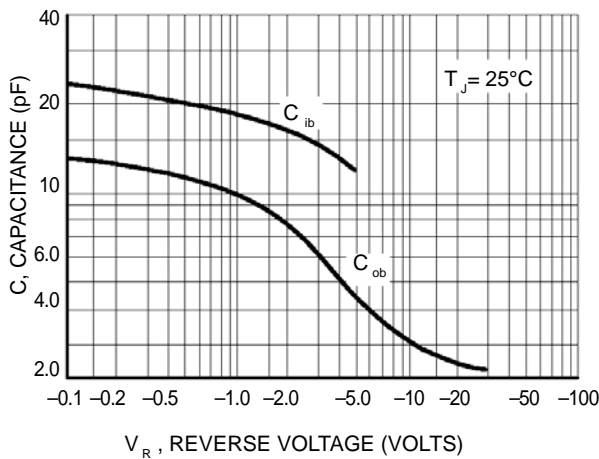

Figure 11. Capacitance

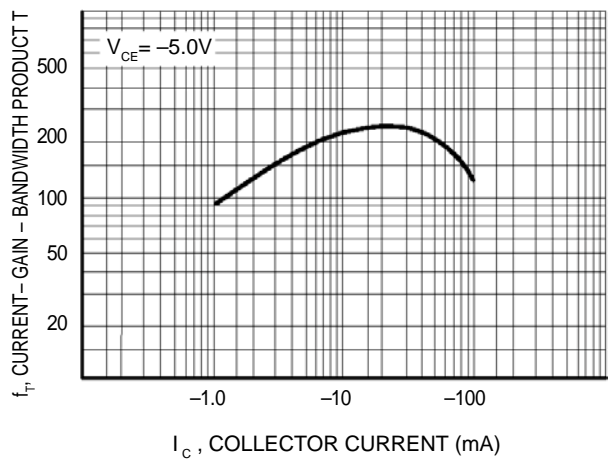

Figure 12. Current-Gain - Bandwidth Product

LBC856AWT1G, BWT1G LBC857AWT1G, BWT1G LBC858AWT1G, BWT1G, CWT1G

www.datasheet4u.com

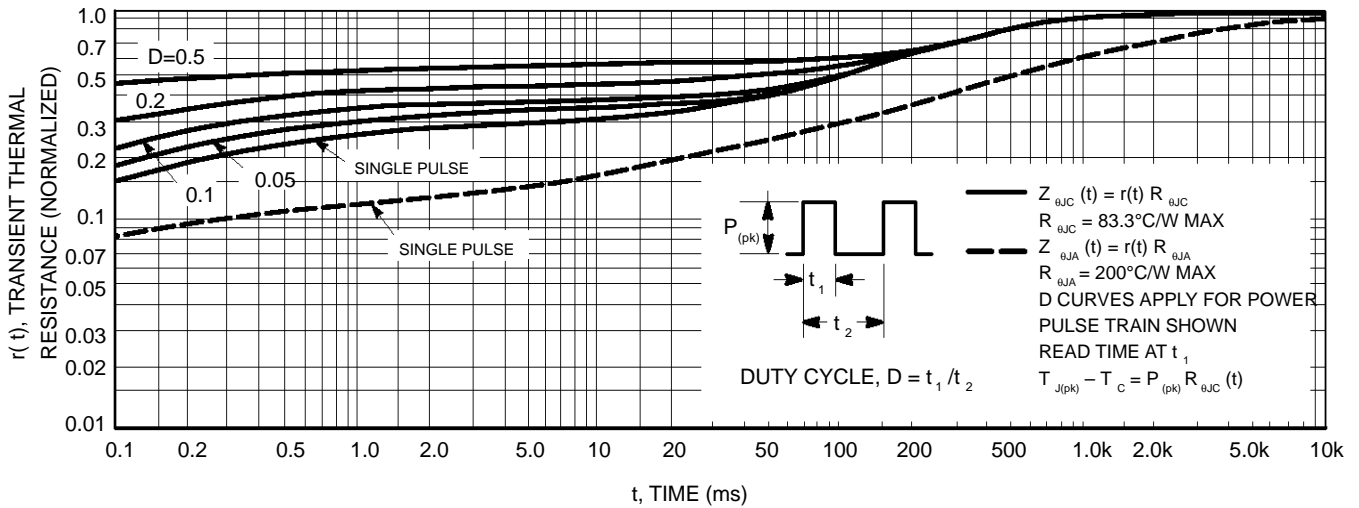

Figure 13. Thermal Response

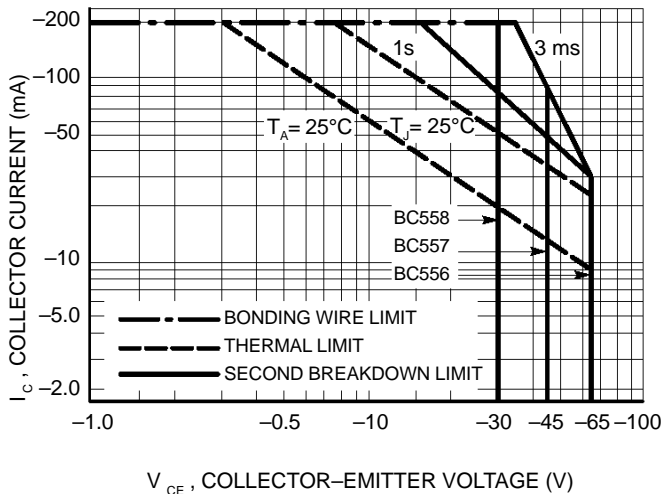

Figure 14. Active Region Safe Operating Area

The safe operating area curves indicate  $I_C - V_{CE}$  limits of the transistor that must be observed for reliable operation. Collector load lines for specific circuits must fall below the limits indicated by the applicable curve.

The data of Figure 14 is based upon  $T_{J(pk)} = 150^\circ\text{C}$ ;  $T_C$  or  $T_A$  is variable depending upon conditions. Pulse curves are valid for duty cycles to 10% provided  $T_{J(pk)} \leq 150^\circ\text{C}$ .  $T_{J(pk)}$  may be calculated from the data in Figure 13. At high case or ambient temperatures, thermal limitations will reduce the power that can be handled to values less than the limitations imposed by the secondary breakdown.

LBC856AWT1G, BWT1G LBC857AWT1G, BWT1G LBC858AWT1G, BWT1G, CWT1G

www.datasheet4u.com

SC-70 / SOT-323

NOTES:

1. DIMENSIONING AND TOLERANCING PER ANSI Y14.5M, 1982.
2. CONTROLLING DIMENSION: INCH.

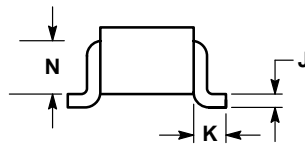
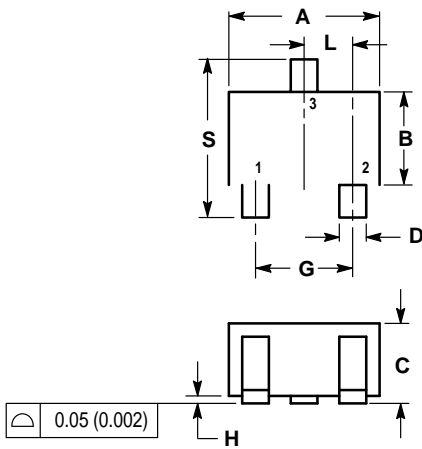

DIM	INCHES		MILLIMETERS	
	MIN	MAX	MIN	MAX
A	0.071	0.087	1.80	2.20
B	0.045	0.053	1.15	1.35
C	0.032	0.040	0.80	1.00
D	0.012	0.016	0.30	0.40
G	0.047	0.055	1.20	1.40
H	0.000	0.004	0.00	0.10
J	0.004	0.010	0.10	0.25
K	0.017 REF		0.425 REF	
L	0.026 BSC		0.650 BSC	
N	0.028 REF		0.700 REF	
S	0.079	0.095	2.00	2.40

- PIN 1. BASE  
 2. EMITTER  
 3. COLLECTOR

