

**250 mW Linear Power Amplifier and T/R Switch**  
**1.8 - 2.0 GHz**

**AM55-0004**  
**V2**

**Features**

- Operates Over Full PCN/PCS/PHS Bands
- Operates Over +3 V to +5 V Supply Voltage
- +24 dBm P<sub>1dB</sub> Typical at PA Out
- 35% PAE @ P<sub>1dB</sub> for Linear Operation
- On-Chip T/R Switch, Linear Operation to +30 dBm
- Low Cost SSOP-28 Plastic Package

**Description**

M/A-COM's AM55-0004 power amplifier/switch integrates a power amplifier and transmit/receive switch in a low cost SSOP package. The power amplifier delivers +24 dBm of linear power with high efficiency and can be operated at supply voltages as low as 2.7 V. It is ideally suited for QPSK or other linearly modulated systems in the 1.8 to 2.0 GHz frequency band. The power amplifier/switch is fully monolithic and requires only one output capacitor for power match. The T/R switch achieves good insertion loss and isolation without degrading the overall linearity. The AM55-0004 is ideally suited for final stage power amplification in linear TDD systems. The integrated switch is convenient for duplexing. The AM55-0004 can also be used as a driver stage for high power systems. Typical applications include Japanese PHS systems or PCN/PCS transmit chains. M/A-COM's AM55-0004 is fabricated using a mature 0.5-micron gate length GaAs process. The process features full passivation for increased performance and reliability.

**Electrical Specifications**

**Test conditions: Frequency: 1.9 GHz, VDD1 = VDD2 = 4.8 V ±10%, VG1 adjusted for 30 mA quiescent bias on VDD1, VG2 adjusted for 65 mA quiescent bias on VDD2, TA= +25°C**

Parameter	Units	Min.	Typ.	Max.
<b>Power Amplifier</b>				
Linear Gain	dB	22	24	
Power Output @ P <sub>1dB</sub> at PA OUT port	dBm	22.5	24	
Current From Positive Supply @ P <sub>1dB</sub>	mA	75	175	275
Input VSWR			2.0:1	
<b>T/R Switch</b>				
Insertion Loss	dB		0.6	1.0
Input Match			1.5:1	
Isolation	dB	15	20	

**SSOP-28**

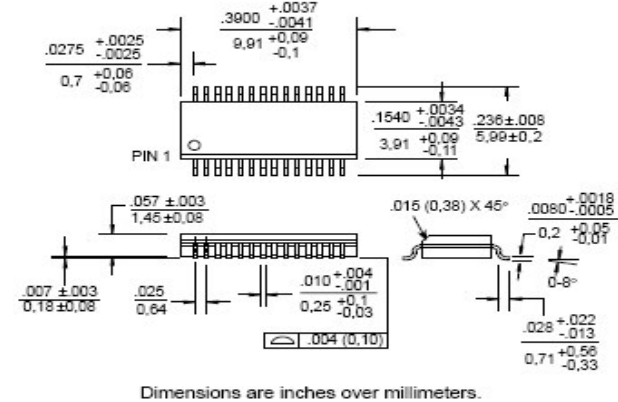

**Ordering Information**

Part Number	Package
AM55-0004	SSOP-28-Lead Plastic Packaging
AM55-0004TR	Forward Tape and Reel*
AM55-0004RTR	Reverse Tape and Reel*
AM55-0004SMB	Designer's Kit

\* If specific reel size is required, consult factory for part number assignment.

**250 mW Linear Power Amplifier and T/R Switch**  
**1.8 - 2.0 GHz**

**AM55-0004**  
**V2**

**Pin Configuration**

Pin No.	Pin Name	Description
1	GND	RF and DC Ground
2	VSW	Complimentary T/R Switch Control, -4 V Tx mode/0 V Rx mode
3	GND	RF and DC Ground
4	Tx IN	Transmit side of T/R switch
5	GND	RD and DC Ground
6	GND	RF and DC Ground
7	ANT IN/OUT	Common port of T/R switch which is connected to the antenna
8	GND	RF and DC Ground
9	Rx OUT	Receive side of T/R switch
10	GND	RF and DC Ground
11	GND	RF and DC Ground
12	V <sub>DD1</sub>	Positive bias for the first stage of PA, +2.7 to +6.0 volts
13	SAVE Tx	Sleep mode control of first stage of PA ONLY 0 V—first PA stage on -4 V—first PA stage off
14	GND	RF and DC Ground
15	GND	RF and DC Ground
16	PA IN	RF input of the Power Amplifier
17	GND	RF and DC Ground
18	V <sub>G1</sub>	Negative bias control for the first PA stage, voltage divider is on the MMIC, adjusted to set V <sub>DD1</sub> quiescent bias current, which is typically 30 mA. Input impedance : 10 k Ω
19	GND	RF and DC Ground
20	V <sub>G2</sub>	Negative bias control for the second PA stage, adjusted to set V <sub>DD2</sub> quiescent bias current, which is typically 65 mA. Input impedance : > 1 M Ω
21	GND	Second Stage RF and DC Ground
22	GND	Second Stage RF and DC Ground
23	GND	Second Stage RF and DC Ground
24	GND	Second Stage RF and DC Ground
25	PA OUT	RF output of the Power Amplifier
26	V <sub>DD2</sub>	Positive bias for the second stage of the PA, +2.7 to +6.0 volts
27	VSW	T/R Switch Control, 0 V Tx mode/ -4 V Rx mode
28	GND	RF and DC Ground

**Absolute Maximum Ratings** <sup>1</sup>

Parameter	Absolute Maximum
Max. Input Power <sup>2</sup>	+10 VDC
Operating Voltages <sup>2</sup>	V <sub>DD</sub> = 7V V <sub>GG</sub> = -5 V V <sub>DD</sub> - V <sub>GG</sub> = 8V
Operating Temperature	-40°C to +85°C
Storage Temperature	-65°C to +150°C

- Exceeding any one or combination of these limits may cause permanent damage to this device.
- Ambient temperature (T<sub>A</sub>) = +25°C.

**Truth Table**

Operating Mode	VSW	<u>VSW</u>	SAVE Tx
PA Tx	X	X	0 V
PA Sleep	X	X	-4.0 Volts
T/R Switch TX	0 Volts	-4.0 Volts	X
T/R Switch Rx	-4.0 Volts	0 Volts	X

X = Don't Care

**Functional Diagram and Pin Configuration**

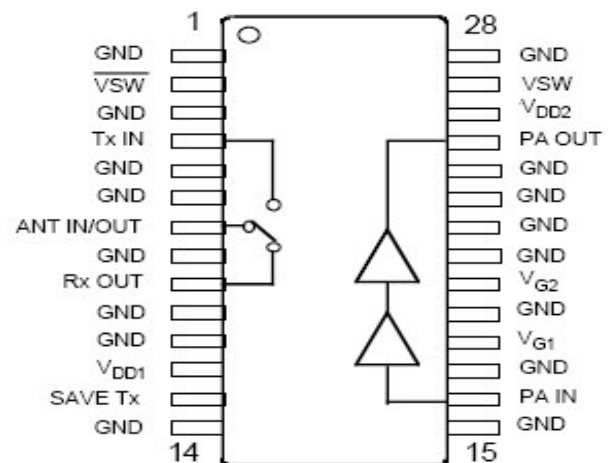

**250 mW Linear Power Amplifier and T/R Switch**  
**1.8 - 2.0 GHz**

**AM55-0004**  
**V2**

**Power Amplifier Small Signal Performance<sup>1</sup>**

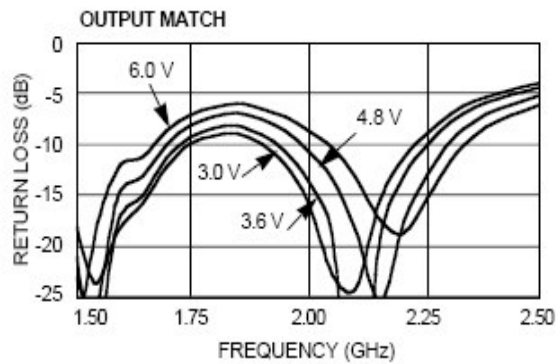
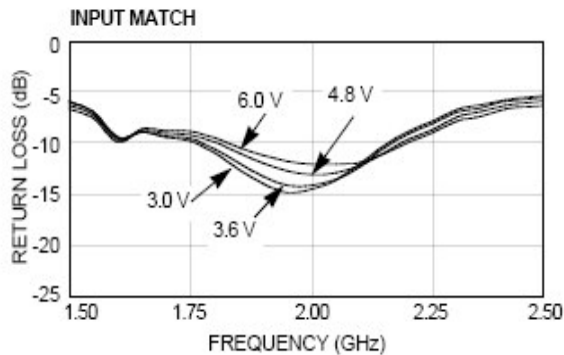
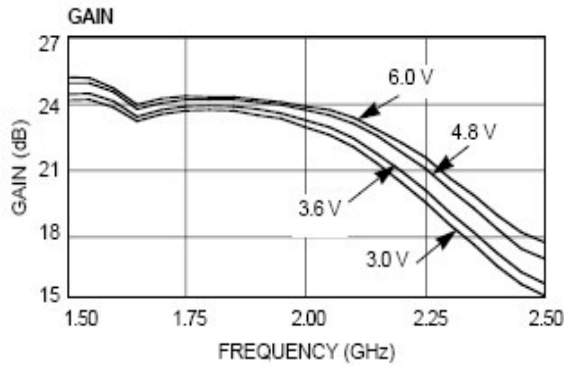

**Power Amplifier CW Performance at 1.9 GHz<sup>1</sup>**

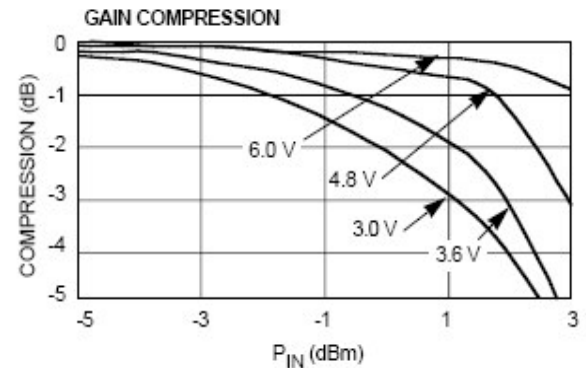
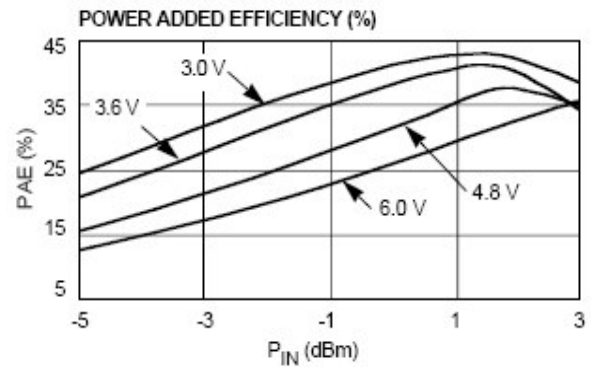
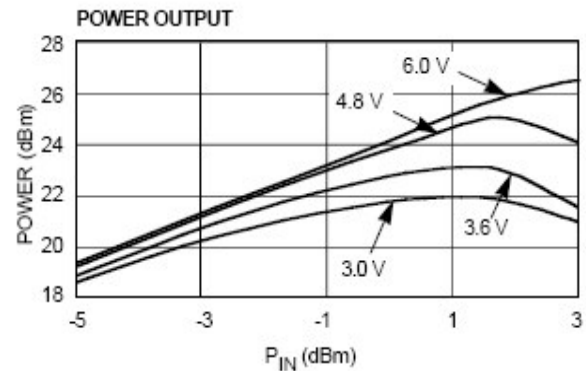

1. All data measured at  $T_A = +25^\circ\text{C}$  and  $V_{G1}$ ,  $V_{G2}$  adjusted for first stage quiescent current of 30 mA and second stage current of 65 mA, respectively.

**250 mW Linear Power Amplifier and T/R Switch**  
**1.8 - 2.0 GHz**

**AM55-0004**  
**V2**

**Power Amplifier Temperature Performance<sup>1</sup>**

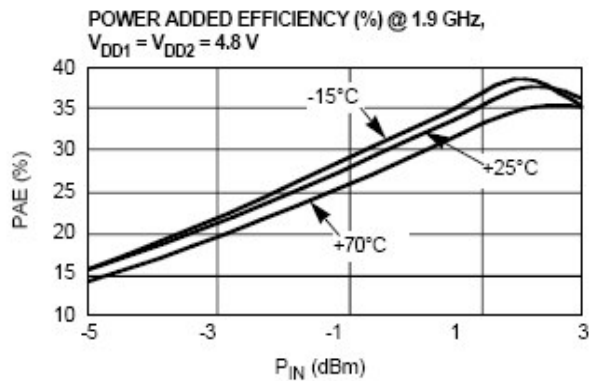
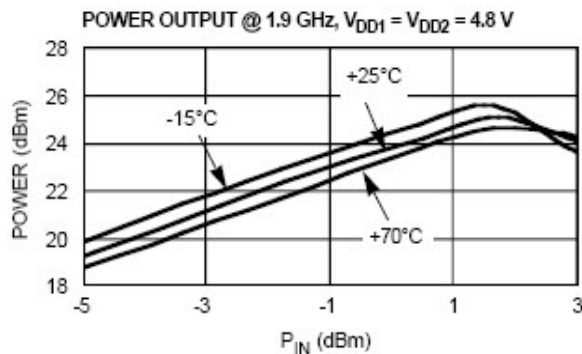
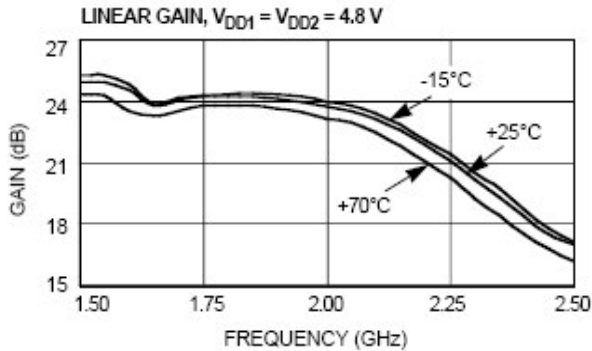

**Power Amplifier Spurious Response at Various Supply Voltages<sup>1</sup>**

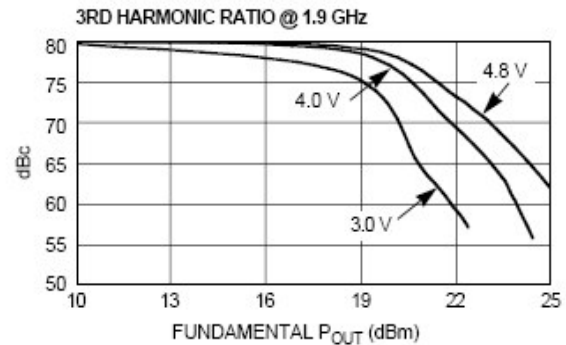
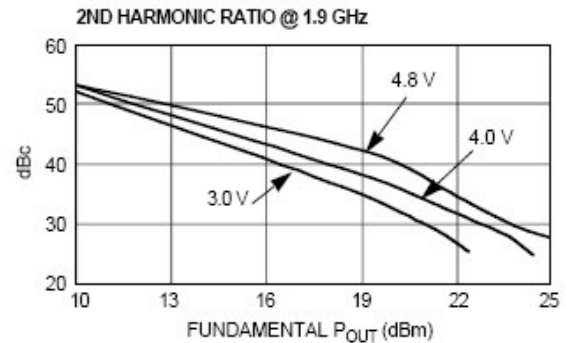
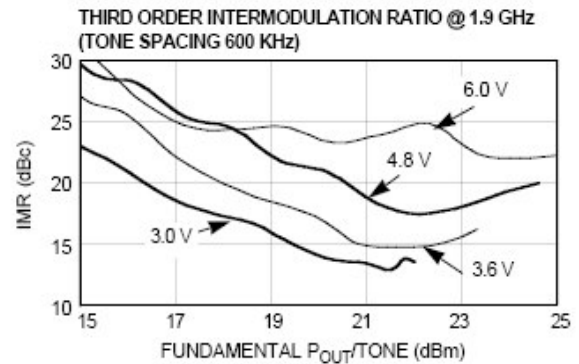

1. All data measured at  $T_A = +25^\circ\text{C}$  and  $V_{G1}$ ,  $V_{G2}$  adjusted for first stage quiescent current of 30 mA and second stage current of 65 mA, respectively.

**250 mW Linear Power Amplifier and T/R Switch**  
**1.8 - 2.0 GHz**

**AM55-0004**  
**V2**

**Power Amplifier Spectral Response Under Modulation Drive ( $\neq/4$  DQPSK,  $a = 0.5$ , 384 kB/sec, 9-bit PN code)**

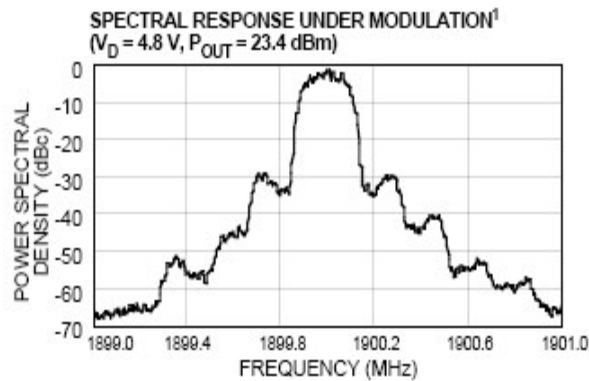
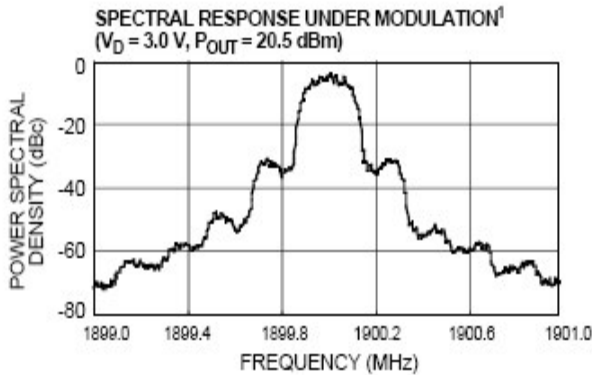

**Output Power Under Modulation <sup>2</sup>**

V <sub>D</sub> (volts)	P <sub>OUT</sub> (dBm)
3	20.5
3.6	21.4
4	22.2
4.8	23.4
6	23.7

- Spectral output is tested under the following conditions: Modulation scheme is  $\neq/4$  DQPSK with a bit transfer rate of 384 kB/sec and a root Nyquist filter with  $a = 0.5$  per RCR STD-28. The spectrum analyzer settings are as follows:  
Resolution bandwidth: 10 kHz  
Video bandwidth: 100 kHz  
Sweep time: 5 seconds

2. This chart documents the modulated output power delivered for a fixed adjacent channel interference (ACI) rejection of 55

**Transmit/Receive Switch Performance**

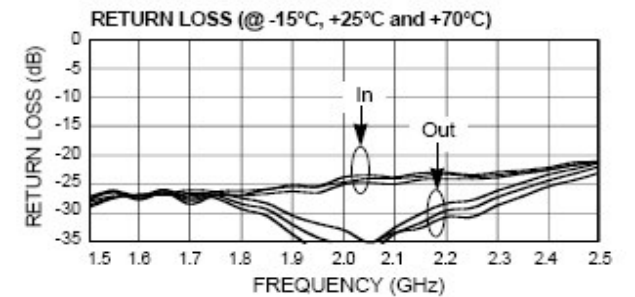
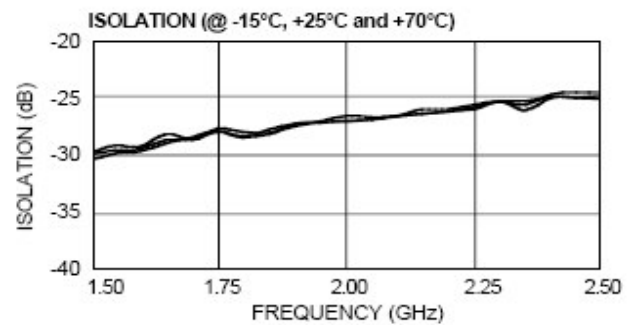
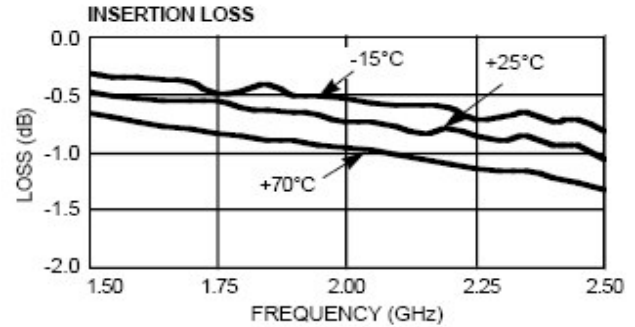

**250 mW Linear Power Amplifier and T/R Switch**  
**1.8 - 2.0 GHz**

**AM55-0004**  
**V2**

**Recommended PCB Configuration**

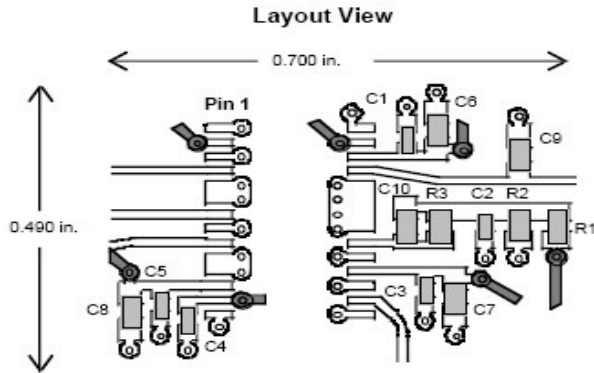

**Cross-Section View**

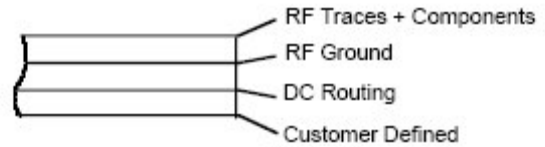

The PCB dielectric between RF traces and RF ground layers should be chosen to reduce RF discontinuities between 50- $\Omega$  lines and package pins. M/A-COM recommends an FR-4 dielectric thickness of 0.008 in. (0.2 mm), yielding a 50- $\Omega$  line width of 0.015 in. (0.38 mm). The recommended metalization thickness is 1 oz. copper. Shaded traces are vias to DC routing layer and traces on DC routing layer.

**External Circuitry Parts List**

Label	Value	Purpose
C1 - C5	1000 pF	Low Frequency bypass
C6 - C8	68 pF	RF bypass
C9	1.5 pF	Output power tuning
C10	15 pF	Reduces low frequency gain
R1	2.7 k $\Omega$	Voltage divider to $V_{G2}$
R2	1.5 k $\Omega$	Voltage divider to $V_{G2}$
R3	150 $\Omega$	Reduces low frequency gain
Tline	0.250 in. long	Power match

All off-chip components are low-cost surface mount components obtainable from multiple sources. (0.020 in. x 0.040 in. or 0.030 in. x 0.050 in.)

**Biasing Procedure**

The AM55-0004 requires that  $V_{GG}$  bias be applied prior to *any*  $V_{DD}$  bias. Permanent damage may occur if this procedure is not followed. All FETs in the PA will draw excessive current and damage internal circuitry.

**External Circuitry**

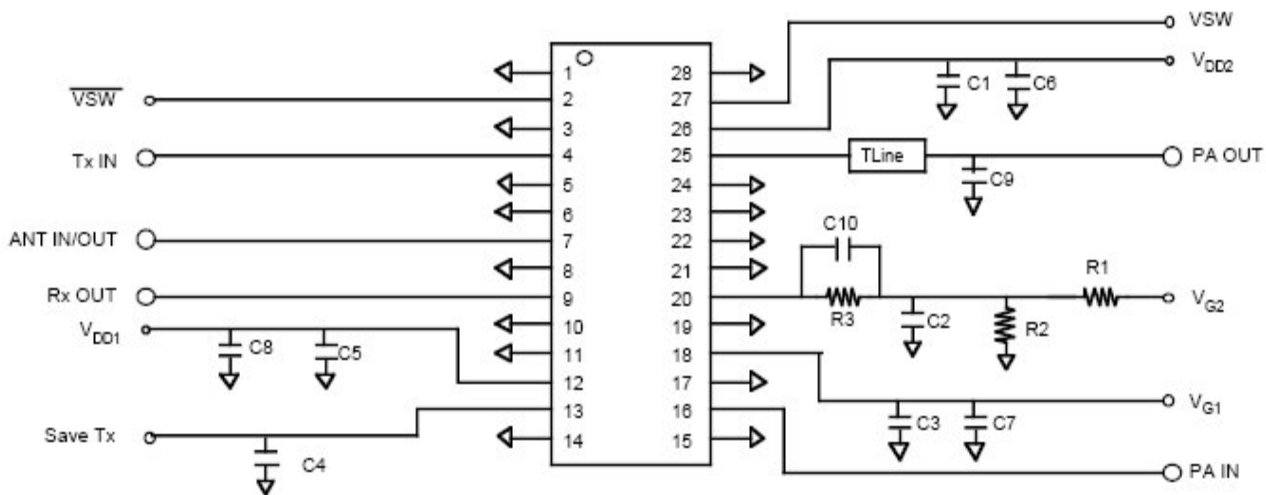



**250 mW Linear Power Amplifier and T/R Switch**  
**1.8 - 2.0 GHz**

**AM55-0004**  
**V2**

**Designer's Kit (AM55-0004SMB)**

The AM55-0004SMB Designer's Kit allows for immediate evaluation of M/A-COM's AM55-0004 integrated Power Amplifier and T/R Switch. The evaluation board consists of an AM55-0004, recommended external surface mount circuitry, RF connectors and a DC multipin connector, all mounted to a multi-layer FR-4 PCB. Other items included in the Designer's Kit: a floppy disk (with typical performance data and a .DXF file of the recommended PCB layout) and any additional Application Notes. The AM55-0004SMB PA/Switch evaluation PCB and block diagram are illustrated below with all functional ports labeled.

**P/A Switch Sample Board**

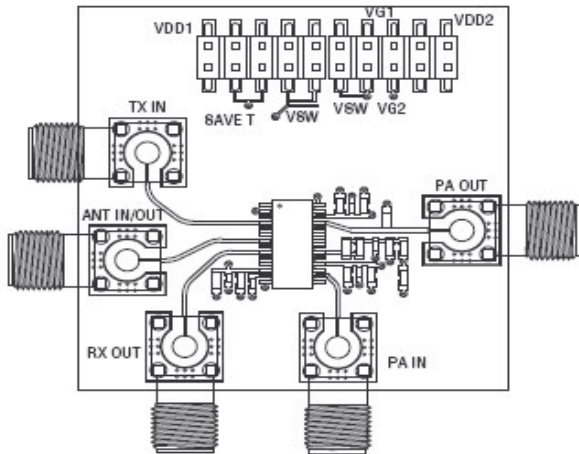

**Functional Block Diagram**

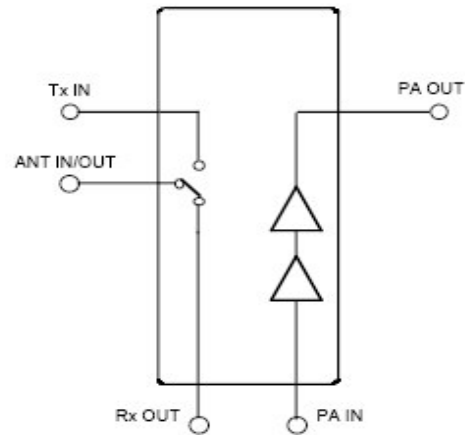

**DC Connector Pinout**

PCB DC Connector	Function	Device Pin Number
1	N/C	N/C
2	VDD1 (+ 4.8 V)	12
3	SAVE Tx (0 V/-4 V)	13
4	GND	N/C
5	SAVE Tx (0 V/-4 V)	13
6	VG1	18
7	VSW	2
8	GND	N/C
9	VSW	2
10	VG1	18

PCB DC Connector	Function	Device Pin Number
11	VSW	27
12	VG1	18
13	VSW	27
14	GND	N/C
15	VG2	20
16	VG1	18
17	N/C	N/C
18	VG2	20
19	N/C	N/C
20	VDD2 (+ 4.8 V)	26

7

M/A-COM Inc. and its affiliates reserve the right to make changes to the product(s) or information contained herein without notice. M/A-COM makes no warranty, representation or guarantee regarding the suitability of its products for any particular purpose, nor does M/A-COM assume any liability whatsoever arising out of the use or application of any product(s) or information.

- **North America** Tel: 800.366.2266 / Fax: 978.366.2266
- **Europe** Tel: 44.1908.574.200 / Fax: 44.1908.574.300
- **Asia/Pacific** Tel: 81.44.844.8296 / Fax: 81.44.844.8298

Visit [www.macom.com](http://www.macom.com) for additional data sheets and product information.

### AM55-0004SMB Biasing Procedure

In order to prevent transients which may damage the MMIC, please adhere to the following procedure.

- Turn on all power supplies and set all voltages to 0 volts BEFORE connecting the power supplies to the DC connector.
  - Apply -4.0 volt supply or GND to DC connector pin 9 (VSW, see truth table for desired mode).
  - Apply -4.0 volt supply or GND to DC connector pin 13 (VSW, see truth table for desired mode).
  - Apply a -4.0 volt supply to the DC connector pin 16 (VG1).
  - Apply a -4.0 volt supply to the DC connector pin 18 (VG2).
  - Apply a +4.8 volt supply to the DC connector pin 2 (VDD1).
  - Apply a +4.8 volt supply to the DC connector pin 20 (VDD2).
  - Apply GND to DC connector pin 5 (Save Tx).
  - Adjust VG1 supply for desired VDD1 quiescent current (typically 30 mA).
  - Adjust VG2 supply for desired VDD2 quiescent current (typically 65 mA).
  - Change voltage on DC connector pin 5 as required (Save Tx, see truth table for desired mode).
  - Apply RF power and test.
  - To power off, reverse above procedure
1. Set VG1 & VG2 to -4 V.
  2. Set VDD1 & VDD2 to 0 V.
  3. Set control voltage supplies to 0 V.
  4. Disconnect bias lines from DC connector.
  5. Turn off power supplies.

### Evaluation PCB and RF Connector Losses

Port Reference	Estimated Loss (dB)
PA IN	0.15
PA OUT	0.20
Tx IN	0.20
ANT IN/OUT	0.20
Rx OUT	0.20

The DC connector on the Designer's Kit PCB allows selection of all the device's operating modes.

It is accomplished by one or more of the following methods:

1. A mating female multi-pin connector (Newark Electronics Stock # 46F-4658, not included)
2. Wires soldered to the necessary pins (not included)
3. Clip leads (not included)
4. A combination of clip leads or wires and jumpers (jumpers included as required)