

# Complementary Silicon Plastic Power Transistors

... designed for use as high-frequency drivers in audio amplifiers.

- DC Current Gain Specified to 4.0 Amperes  
 $h_{FE} = 40$  (Min) @  $I_C = 3.0$  Adc  
 $= 20$  (Min) @  $I_C = 4.0$  Adc
- Collector-Emitter Sustaining Voltage —  
 $V_{CEO(sus)} = 120$  Vdc (Min) — MJE15028, MJE15029  
 $= 150$  Vdc (Min) — MJE15030, MJE15031
- High Current Gain — Bandwidth Product  
 $f_T = 30$  MHz (Min) @  $I_C = 500$  mAdc
- TO-220AB Compact Package

## MAXIMUM RATINGS

Rating	Symbol	MJE15028 MJE15029	MJE15030 MJE15031	Unit
Collector-Emitter Voltage	$V_{CEO}$	120	150	Vdc
Collector-Base Voltage	$V_{CB}$	120	150	Vdc
Emitter-Base Voltage	$V_{EB}$	5.0		Vdc
Collector Current — Continuous — Peak	$I_C$	8.0 16		Adc
Base Current	$I_B$	2.0		Adc
Total Power Dissipation @ $T_C = 25^\circ\text{C}$ Derate above $25^\circ\text{C}$	$P_D$	50 0.40		Watts W/ $^\circ\text{C}$
Total Power Dissipation @ $T_A = 25^\circ\text{C}$ Derate above $25^\circ\text{C}$	$P_D$	2.0 0.016		Watts W/ $^\circ\text{C}$
Operating and Storage Junction Temperature Range	$T_J, T_{stg}$	-65 to +150		$^\circ\text{C}$

## THERMAL CHARACTERISTICS

Characteristic	Symbol	Max	Unit
Thermal Resistance, Junction to Case	$R_{\theta JC}$	2.5	$^\circ\text{C/W}$
Thermal Resistance, Junction to Ambient	$R_{\theta JA}$	62.5	$^\circ\text{C/W}$

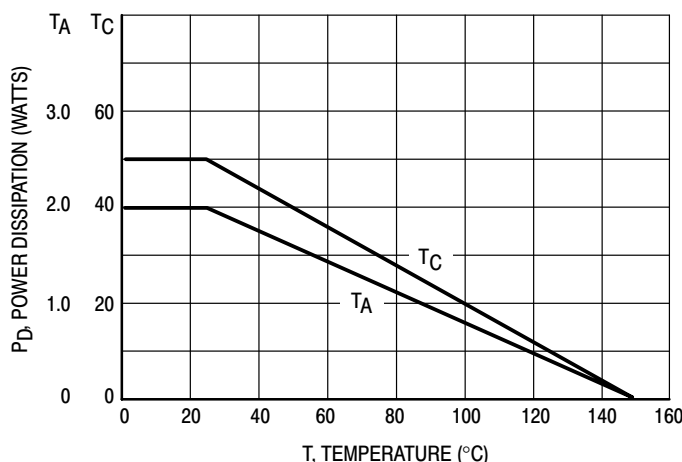


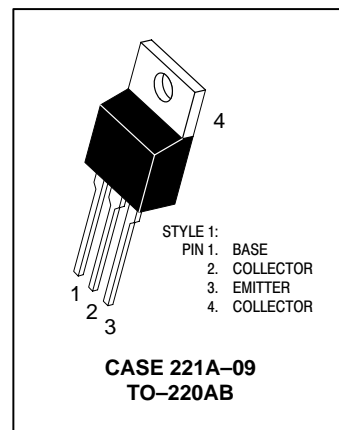
Figure 1. Power Derating

Preferred devices are ON Semiconductor recommended choices for future use and best overall value.

**NPN**  
**MJE15028\***  
**MJE15030\***  
**PNP**  
**MJE15029\***  
**MJE15031\***

\*ON Semiconductor Preferred Device

**8 AMPERE**  
**POWER TRANSISTORS**  
**COMPLEMENTARY**  
**SILICON**  
**120-150 VOLTS**  
**50 WATTS**



# MJE15028 MJE15030 MJE15029 MJE15031

## ELECTRICAL CHARACTERISTICS ( $T_C = 25^\circ\text{C}$ unless otherwise noted)

Characteristic	Symbol	Min	Max	Unit	
<b>OFF CHARACTERISTICS</b>					
Collector–Emitter Sustaining Voltage (1) ( $I_C = 10\text{ mA}$ , $I_B = 0$ )	MJE15028, MJE15029 MJE15030, MJE15031	$V_{CE(sus)}$	120 150	— —	Vdc
Collector Cutoff Current ( $V_{CE} = 120\text{ Vdc}$ , $I_B = 0$ ) ( $V_{CE} = 150\text{ Vdc}$ , $I_B = 0$ )	MJE15028, MJE15029 MJE15030, MJE15031	$I_{CEO}$	— —	0.1 0.1	mAdc
Collector Cutoff Current ( $V_{CB} = 120\text{ Vdc}$ , $I_E = 0$ ) ( $V_{CB} = 150\text{ Vdc}$ , $I_E = 0$ )	MJE15028, MJE15029 MJE15030, MJE15031	$I_{CBO}$	— —	10 10	$\mu\text{Adc}$
Emitter Cutoff Current ( $V_{BE} = 5.0\text{ Vdc}$ , $I_C = 0$ )		$I_{EBO}$	—	10	$\mu\text{Adc}$
<b>ON CHARACTERISTICS (1)</b>					
DC Current Gain ( $I_C = 0.1\text{ Adc}$ , $V_{CE} = 2.0\text{ Vdc}$ ) ( $I_C = 2.0\text{ Adc}$ , $V_{CE} = 2.0\text{ Vdc}$ ) ( $I_C = 3.0\text{ Adc}$ , $V_{CE} = 2.0\text{ Vdc}$ ) ( $I_C = 4.0\text{ Adc}$ , $V_{CE} = 2.0\text{ Vdc}$ )		$h_{FE}$	40 40 40 20	— — — —	—
DC Current Gain Linearity ( $V_{CE}$ From 2.0 V to 20 V, $I_C$ From 0.1 A to 3 A) (NPN TO PNP)		$h_{FE}$	<b>Typ</b> 2 3		
Collector–Emitter Saturation Voltage ( $I_C = 1.0\text{ Adc}$ , $I_B = 0.1\text{ Adc}$ )		$V_{CE(sat)}$	—	0.5	Vdc
Base–Emitter On Voltage ( $I_C = 1.0\text{ Adc}$ , $V_{CE} = 2.0\text{ Vdc}$ )		$V_{BE(on)}$	—	1.0	Vdc
<b>DYNAMIC CHARACTERISTICS</b>					
Current Gain — Bandwidth Product (2) ( $I_C = 500\text{ mA}$ , $V_{CE} = 10\text{ Vdc}$ , $f_{test} = 10\text{ MHz}$ )		$f_T$	30	—	MHz

(1) Pulse Test: Pulse Width  $\leq 300\ \mu\text{s}$ , Duty Cycle  $\leq 2.0\%$ .

(2)  $f_T = |h_{fe}| \cdot f_{test}$ .

MJE15028 MJE15030 MJE15029 MJE15031

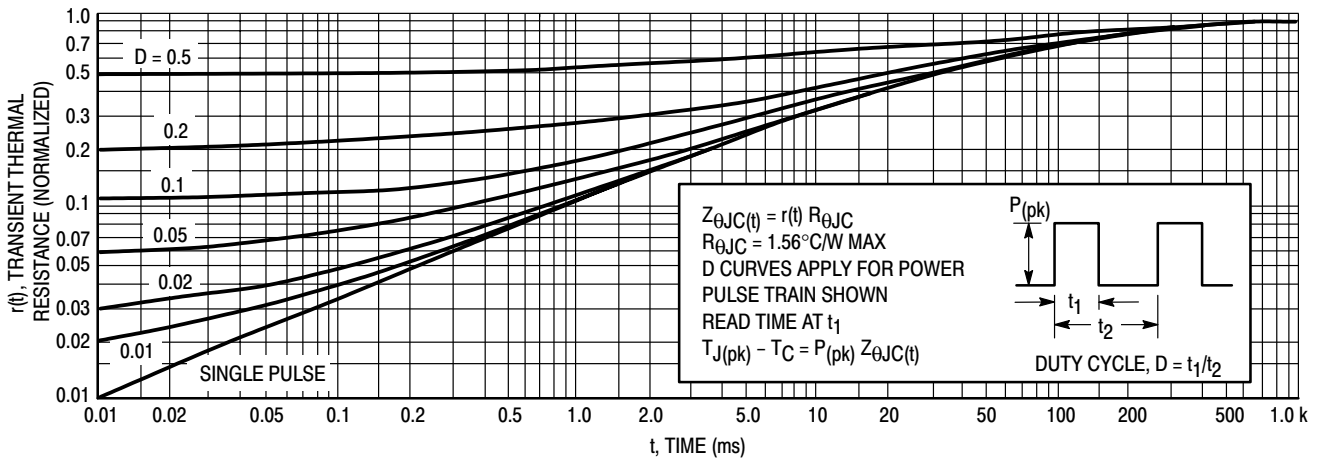


Figure 2. Thermal Response

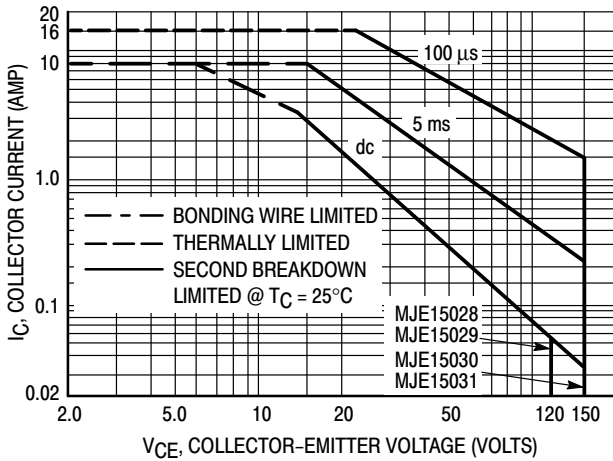


Figure 3. Forward Bias Safe Operating Area

There are two limitations on the power handling ability of a transistor: average junction temperature and second breakdown. Safe operating area curves indicate  $I_C - V_{CE}$  limits of the transistor that must be observed for reliable operation, i.e., the transistor must not be subjected to greater dissipation than the curves indicate.

The data of Figures 3 and 4 is based on  $T_{J(pk)} = 150^{\circ}\text{C}$ ;  $T_C$  is variable depending on conditions. Second breakdown pulse limits are valid for duty cycles to 10% provided  $T_{J(pk)} < 150^{\circ}\text{C}$ .  $T_{J(pk)}$  may be calculated from the data in Figure 2. At high case temperatures, thermal limitations will reduce the power that can be handled to values less than the limitations imposed by second breakdown.

MJE15028 MJE15030 MJE15029 MJE15031

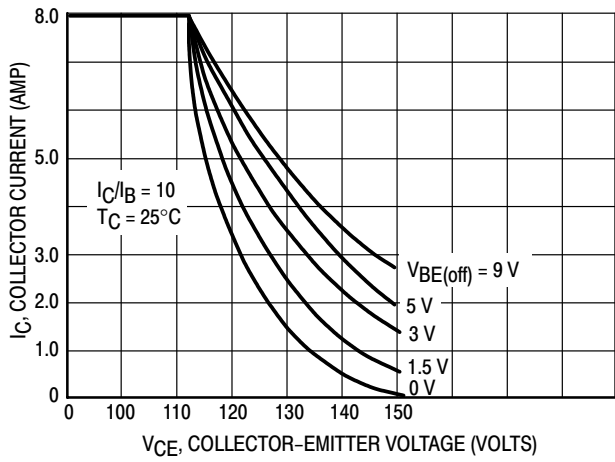


Figure 4. Reverse-Bias Switching Safe Operating Area

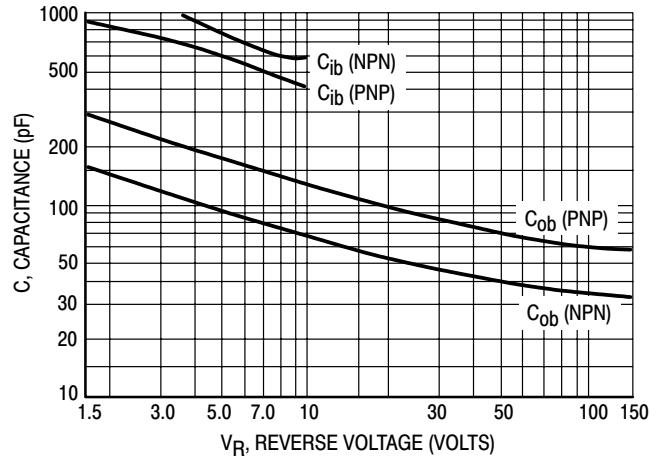


Figure 5. Capacitances

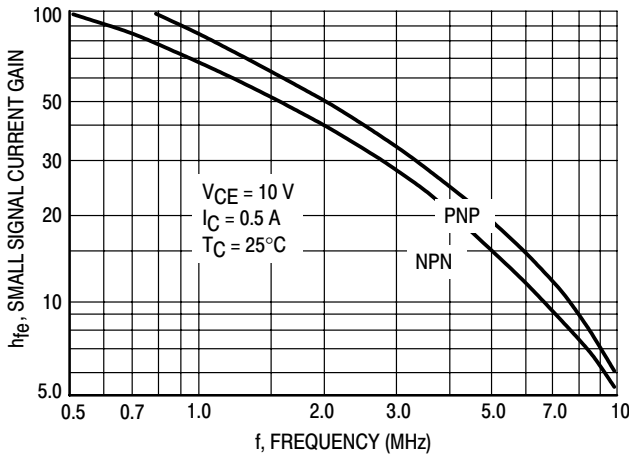


Figure 6. Small-Signal Current Gain

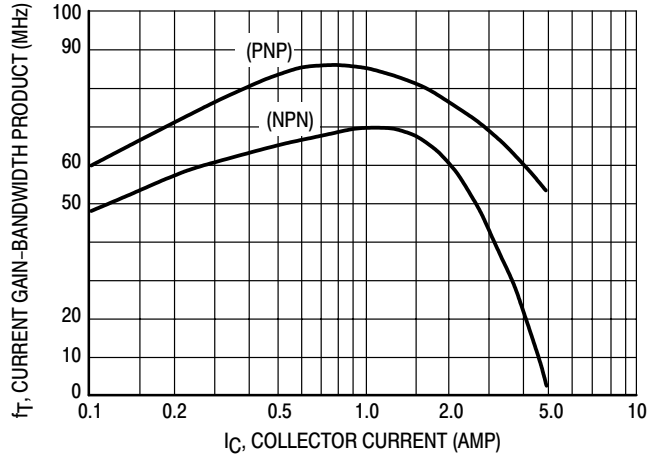
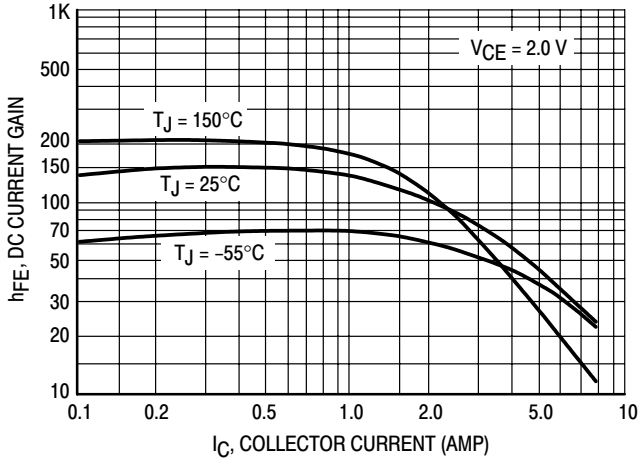


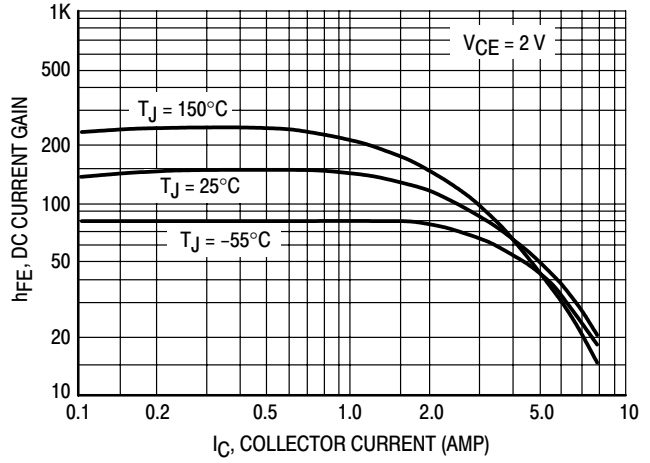
Figure 7. Current Gain-Bandwidth Product

# MJE15028 MJE15030 MJE15029 MJE15031

**NPN — MJE15028 MJE15030**

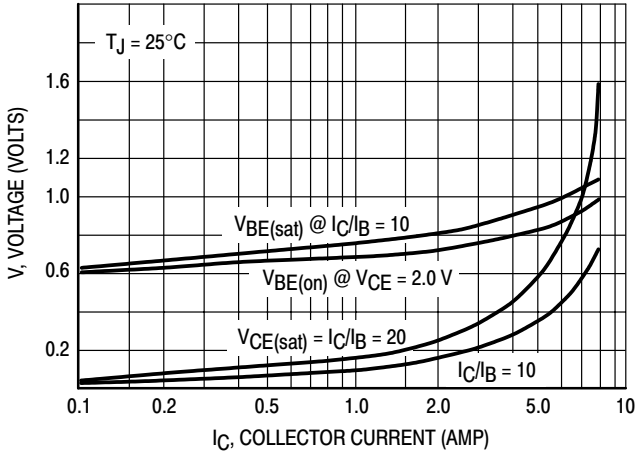


**PNP — MJE15029 MJE15031**

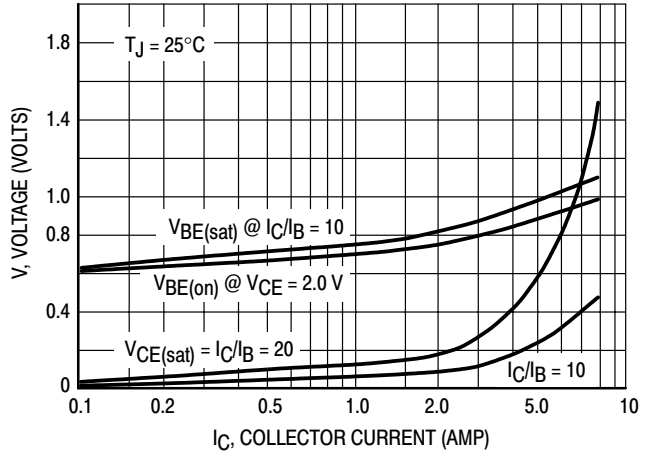


**Figure 8. DC Current Gain**

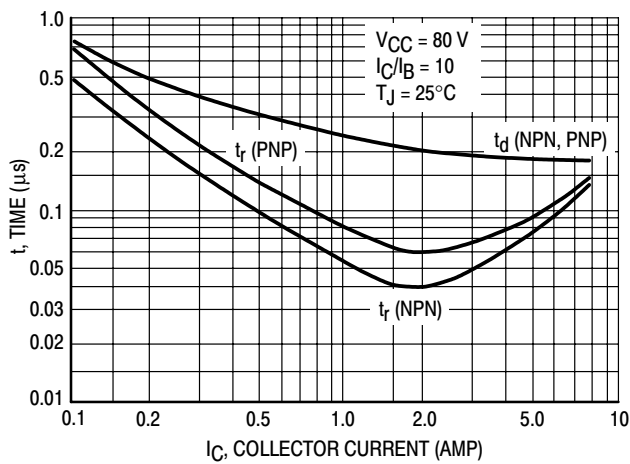
**NPN**



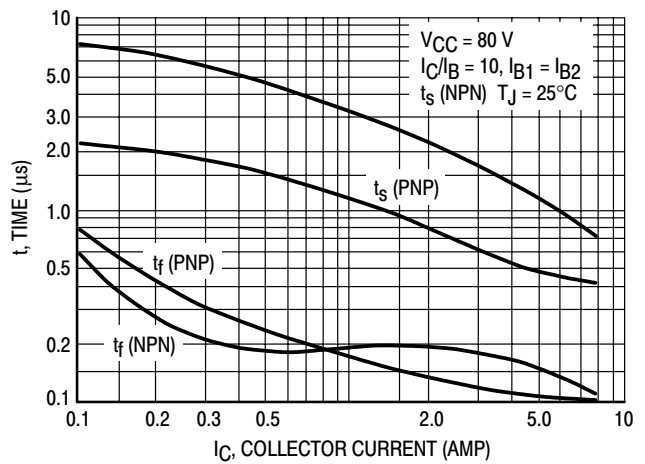
**PNP**



**Figure 9. "On" Voltage**



**Figure 10. Turn-On Times**

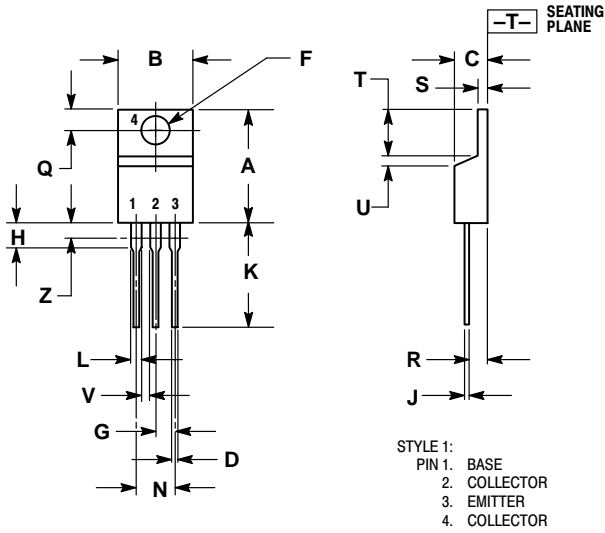


**Figure 11. Turn-Off Times**

# MJE15028 MJE15030 MJE15029 MJE15031

## PACKAGE DIMENSIONS

### TO-220AB CASE 221A-09 ISSUE AA



NOTES:

1. DIMENSIONING AND TOLERANCING PER ANSI Y14.5M, 1982.
2. CONTROLLING DIMENSION: INCH.
3. DIMENSION Z DEFINES A ZONE WHERE ALL BODY AND LEAD IRREGULARITIES ARE ALLOWED.

DIM	INCHES		MILLIMETERS	
	MIN	MAX	MIN	MAX
A	0.570	0.620	14.48	15.75
B	0.380	0.405	9.66	10.28
C	0.160	0.190	4.07	4.82
D	0.025	0.035	0.64	0.88
F	0.142	0.147	3.61	3.73
G	0.095	0.105	2.42	2.66
H	0.110	0.155	2.80	3.93
J	0.018	0.025	0.46	0.64
K	0.500	0.562	12.70	14.27
L	0.045	0.060	1.15	1.52
N	0.190	0.210	4.83	5.33
Q	0.100	0.120	2.54	3.04
R	0.080	0.110	2.04	2.79
S	0.045	0.055	1.15	1.39
T	0.235	0.255	5.97	6.47
U	0.000	0.050	0.00	1.27
V	0.045	---	1.15	---
Z	---	0.080	---	2.04

## Notes

**ON Semiconductor** and  are registered trademarks of Semiconductor Components Industries, LLC (SCILLC). SCILLC reserves the right to make changes without further notice to any products herein. SCILLC makes no warranty, representation or guarantee regarding the suitability of its products for any particular purpose, nor does SCILLC assume any liability arising out of the application or use of any product or circuit, and specifically disclaims any and all liability, including without limitation special, consequential or incidental damages. "Typical" parameters which may be provided in SCILLC data sheets and/or specifications can and do vary in different applications and actual performance may vary over time. All operating parameters, including "Typicals" must be validated for each customer application by customer's technical experts. SCILLC does not convey any license under its patent rights nor the rights of others. SCILLC products are not designed, intended, or authorized for use as components in systems intended for surgical implant into the body, or other applications intended to support or sustain life, or for any other application in which the failure of the SCILLC product could create a situation where personal injury or death may occur. Should Buyer purchase or use SCILLC products for any such unintended or unauthorized application, Buyer shall indemnify and hold SCILLC and its officers, employees, subsidiaries, affiliates, and distributors harmless against all claims, costs, damages, and expenses, and reasonable attorney fees arising out of, directly or indirectly, any claim of personal injury or death associated with such unintended or unauthorized use, even if such claim alleges that SCILLC was negligent regarding the design or manufacture of the part. SCILLC is an Equal Opportunity/Affirmative Action Employer.

## PUBLICATION ORDERING INFORMATION

### Literature Fulfillment:

Literature Distribution Center for ON Semiconductor  
P.O. Box 5163, Denver, Colorado 80217 USA  
**Phone:** 303-675-2175 or 800-344-3860 Toll Free USA/Canada  
**Fax:** 303-675-2176 or 800-344-3867 Toll Free USA/Canada  
**Email:** ONlit@hibbertco.com

**N. American Technical Support:** 800-282-9855 Toll Free USA/Canada

**JAPAN:** ON Semiconductor, Japan Customer Focus Center  
4-32-1 Nishi-Gotanda, Shinagawa-ku, Tokyo, Japan 141-0031  
**Phone:** 81-3-5740-2700  
**Email:** r14525@onsemi.com

**ON Semiconductor Website:** <http://onsemi.com>

For additional information, please contact your local Sales Representative.