

# 856931

## 710/740 MHz Duplexer

### Applications

- For Band 17 LTE applications
- LTE Band 17 handsets, data cards, mobile routers

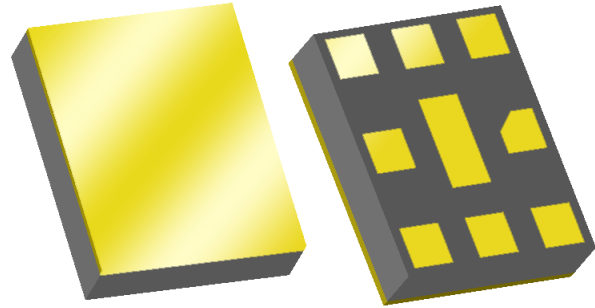

### Product Features

- For LTE Band 17 applications
- Usable bandwidth 12 MHz (each band)
- High Tx-Rx isolation
- Low loss
- High attenuation
- Single ended - Balanced Rx operation
- Ceramic Chip Scale Package (CSP)
- Hermetic
- RoHS compliant (2002/95/EC), Pb-free



### Functional Block Diagram

Top View

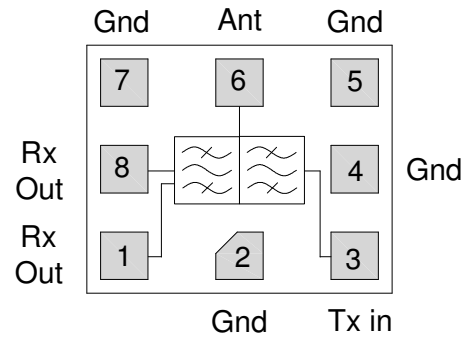

### General Description

856931 is a high-performance Surface Acoustic Wave duplexer designed to meet the strict LTE requirements for use in Band 17.

The 856931 is specifically designed to meet the high performance expectations of insertion loss, isolation and linearity in LTE systems operating in Band 17 applications under all operating conditions.

The 856931 uses common module packaging techniques to achieve the industry standard 2.5 x 2.0 mm<sup>2</sup> footprint. The duplexer exhibits excellent power handling capabilities.

### Pin Configuration

Pin #	SE-Balanced	Description
1,8		Rx output
3		Tx input
6		Antenna/Phasing inductor
2,4,5,7,9		Ground

### Ordering Information

Part No.	Description
856931	Packaged Part
856931-EVB	Evaluation Board

Standard T/R size = 10,000 units/reel.

## Preliminary Data Sheet

### Tx - Electrical Specifications <sup>(1)</sup>

Specified Temperature Range: <sup>(2)</sup> -20 to +90 °C

Parameter <sup>(3)</sup>	Conditions	Min	Typical <sup>(4)</sup>	Max	Units
<b>Ant-Tx Specification</b>					
Center Frequency		-	710	-	MHz
Maximum Insertion Loss	704 – 716 MHz	-	1.8	2.5	dB
Amplitude Variation	704 – 716 MHz (over any 5 MHz in-band)	-	0.7	1.2	dB p-p
Absolute Attenuation <sup>(5)</sup>	10 – 686 MHz	32	34	-	dB
	728 – 734 MHz	15	30	-	dB
	734 – 746 MHz	45	49	-	dB
	746 – 768 MHz	33	38	-	dB
	768 – 805 MHz	30	35	-	dB
	869 – 894 MHz	30	35	-	dB
	1408 – 1432 MHz	30	45	-	dB
	1565 – 1585 MHz	43	50	-	dB
	1597 – 1607 MHz	44	51	-	dB
	1805 – 1880 MHz	40	52	-	dB
	1930 – 1990 MHz	50	60	-	dB
	2110 – 2155 MHz	45	62	-	dB
	2155 – 2170 MHz	50	60	-	dB
2400 – 2484 MHz	45	60	-	dB	
2816 – 3000 MHz	30	55	-	dB	
Return Loss at Tx	704 – 716 MHz	10	12	-	dB
Return Loss at Antenna	704 – 716 MHz	10	12	-	dB
<b>Tx-Rx Specification</b>					
Isolation	704 – 716 MHz (Differential)	54	56	-	dB
	704 – 716 MHz (Common-mode)	54	56	-	dB
	734 – 746 MHz (Differential)	50	52	-	dB
	1408 – 1432 MHz	30	50	-	dB
	2112 – 2148 MHz	30	50	-	dB
	2816 – 3000 MHz	30	50	-	dB
Tx Impedance (single-ended) <sup>(6)</sup>		-	50	-	Ω
Ant Impedance (single-ended) <sup>(6)</sup>		-	50	-	Ω

#### Notes:

- All specifications are based on the TriQuint schematic for the main reference design shown on page 4
- In production, devices will be tested at room temperature to a guardbanded specification to ensure electrical compliance over temperature
- Electrical margin has been built into the design to account for the variations due to temperature drift and manufacturing tolerances
- Typical values are based on average measurements at room temperature
- Relative to zero dB
- This is the optimum impedance in order to achieve the performance shown

**Preliminary Data Sheet**

**Rx - Electrical Specifications <sup>(1)</sup>**

Specified Temperature Range: <sup>(2)</sup> -20 to +90 °C

Parameter <sup>(3)</sup>	Conditions	Min	Typical <sup>(4)</sup>	Max	Units
<b>Ant-Rx Specification</b>					
Center Frequency		-	740	-	MHz
Maximum Insertion Loss	734 – 746 MHz	-	1.9	2.5	dB
Amplitude Variation	734 – 746 MHz (over any 5 MHz in-band)	-	0.5	1.2	dB p-p
Absolute Attenuation <sup>(5)</sup>	10 – 674 MHz	45	48	-	dB
	674 – 686 MHz	53	58	-	dB
	686 – 704 MHz	35	50	-	dB
	704 – 716 MHz	50	53	-	dB
	716 – 722 MHz	32	53	-	dB
	776 – 793 MHz	32	35	-	dB
	793 – 805 MHz	40	42	-	dB
	805 – 2300 MHz	40	42	-	dB
	2300 – 3000 MHz	35	37	-	dB
Return Loss at Rx	734 – 746 MHz	10	12	-	dB
Return Loss at Antenna	734 – 746 MHz	10	12	-	dB
Output phase balance	734 – 746 MHz	-5.0	-	5.0	degree
Output amplitude balance	734 – 746 MHz (Over any 5MHz in-band)	-0.7	-	0.7	dB
IM2 product <sup>(6) (a,b)</sup>		-	-103	-	dBm
IM3 product <sup>(6) (c,d)</sup>		-	-102	-	dBm
ANT Impedance (single-ended) <sup>(7)</sup>		-	50	-	Ω
Rx Impedance (balanced) <sup>(7)</sup>		-	100	-	Ω

Notes:

- All specifications are based on the TriQuint schematic for the main reference design shown on page 4
- In production, devices will be tested at room temperature to a guardbanded specification to ensure electrical compliance over temperature
- Electrical margin has been built into the design to account for the variations due to temperature drift and manufacturing tolerances
- Typical values are based on average measurements at room temperature
- Relative to zero dB
- All power levels are referenced to the antenna port. Two CW tones are applied at frequencies f1 and f2, and the resultant intermodulation product in the Rx band is measured. The first tone is applied to the Tx port, in the range f1 = 704 to 716 MHz, at +21.5 dBm (referenced to the antenna port). The second tone is -15 dBm, applied to the antenna port at f2, with the following four cases:
  - f2 = 30 MHz
  - f2 = 2 \* f1 + 30 MHz
  - f2 = f1 - 30 MHz
  - f2 = 3 \* f1 + 30 MHz
 The intermodulation product is measured at f1 + 30 MHz.
- This is the optimum impedance in order to achieve the performance shown

**Reference Design –Ant- 50Ω SE In, Tx-50Ω SE Out , Rx-100Ω Bal Out**

**Schematic**

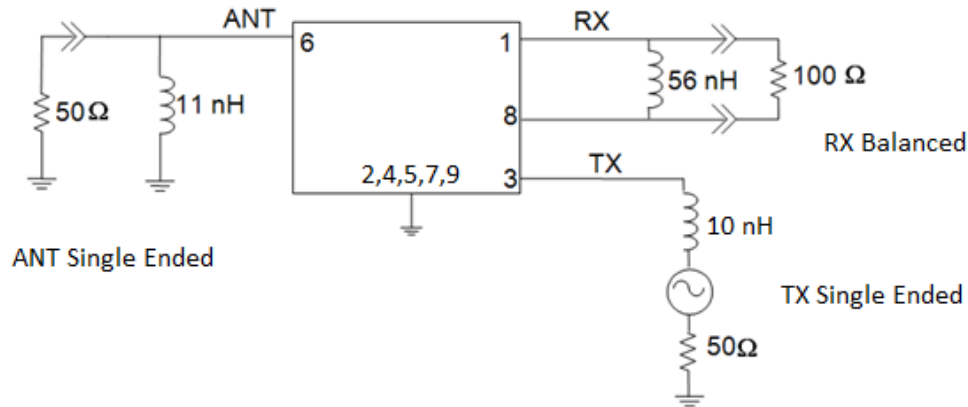

Notes:

1. Actual matching values may vary due to PCB layout and parasitic

**PC Board**

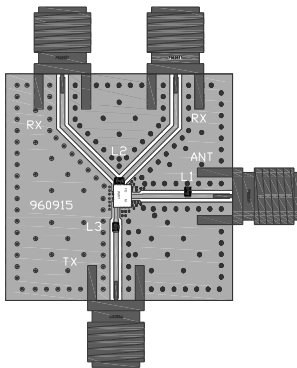

Notes:

- Top, middle & bottom layers: 1 oz copper
- Substrates: FR4 dielectric, .031" thick
- Finish plating: Nickel: 3-8μm thick, Gold: .03-.2μm thick
- Hole plating: Copper min .0008μm thick

**Mounting Configuration**

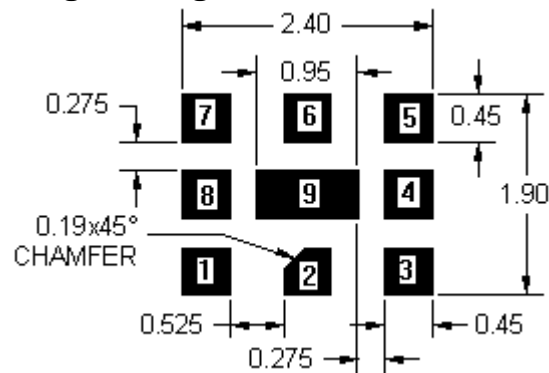

Notes:

1. Top view of the duplexer.
2. All dimensions are in millimeters.
3. This footprint represents a recommendation only.

**Bill of Material**

Reference Design	Value	Description	Manufacturer	Part Number
L1 at ANT	11 nH	Chip inductor, Wire wound, 0402, ±2%	MuRata	LQW15AN11NG00
L2 at Rx	56 nH	Chip inductor Wire-wound, 0402, ±3%	MuRata	LQW15AN56NH00
L3 at Tx	10 nH	Chip inductor Wire-wound, 0402, ±3%	MuRata	LQW15AN10NG00
SMA	N/A	SMA connector	Radiall USA Inc.	9602-1111-018
PCB	N/A	3-layer	multiple	N/A

**Tx - Typical Performance (at room temperature)**

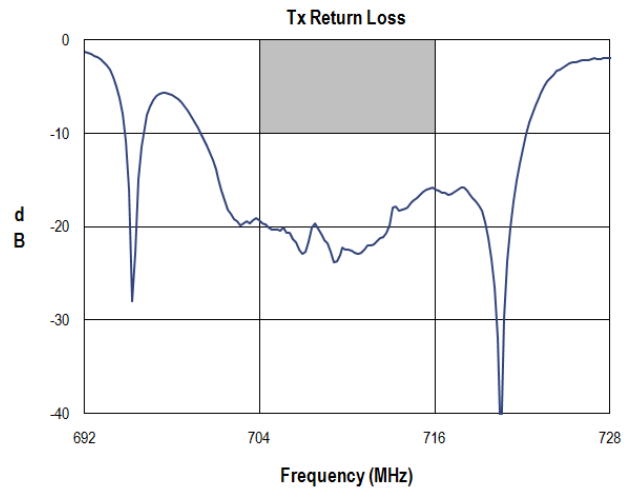
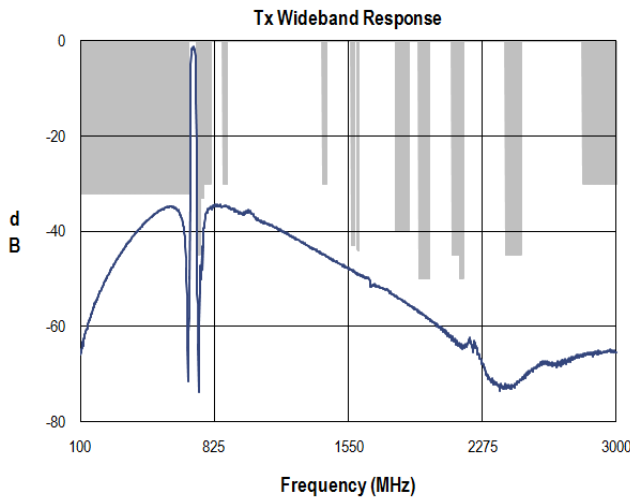
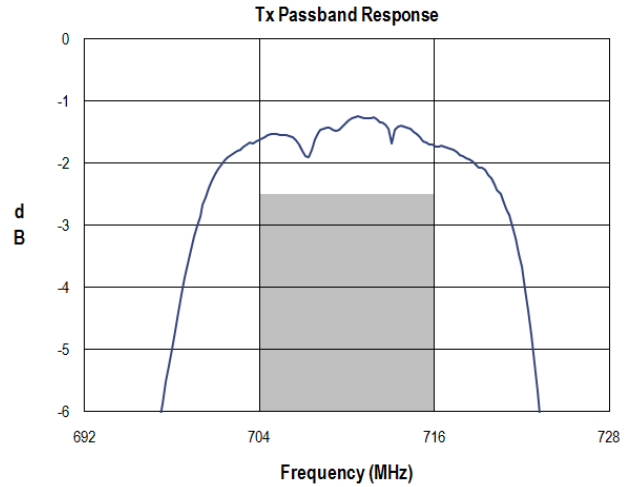
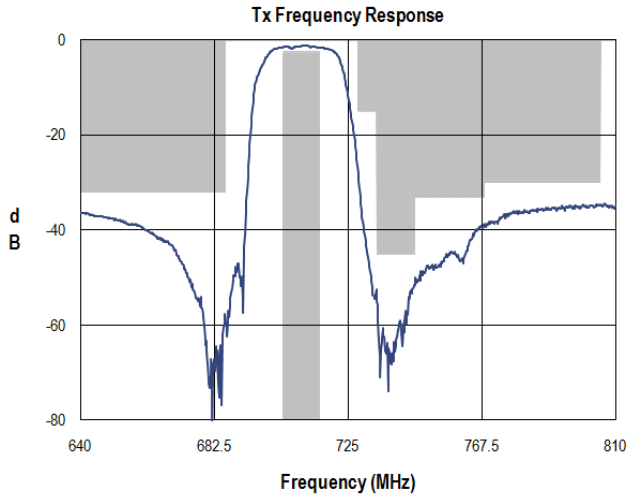

**Tx Path - Ant Port Impedance**

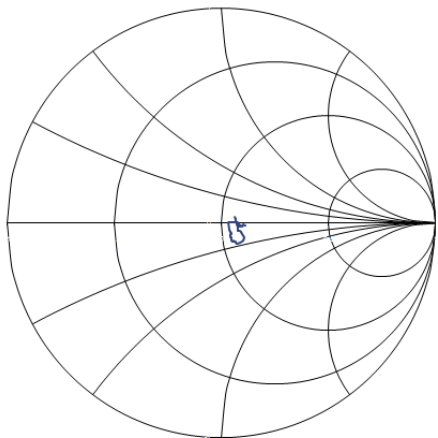

**Tx Port Impedance**

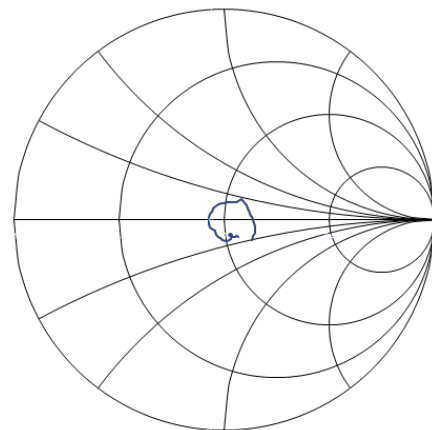

**Tx -Rx Isolation Typical Performance (at room temperature)**

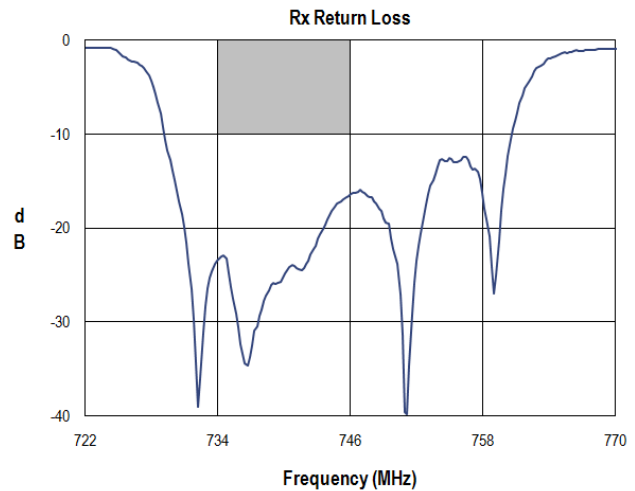
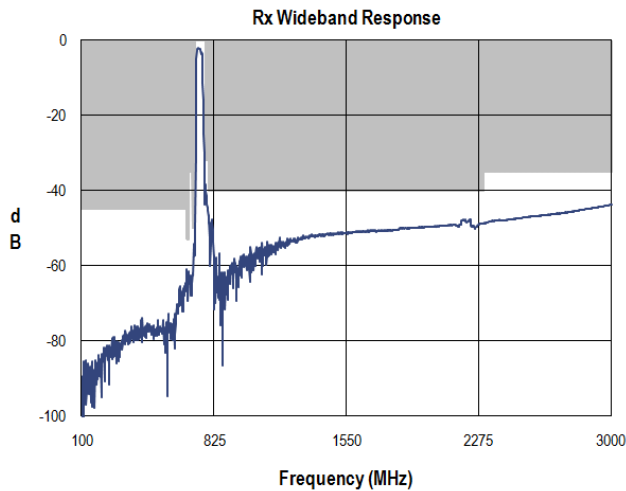
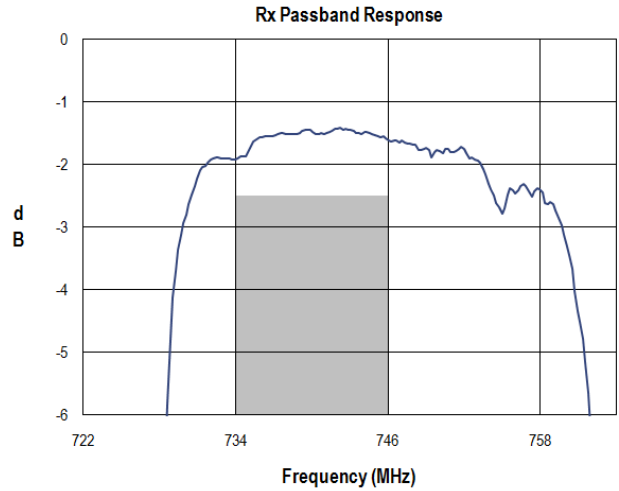
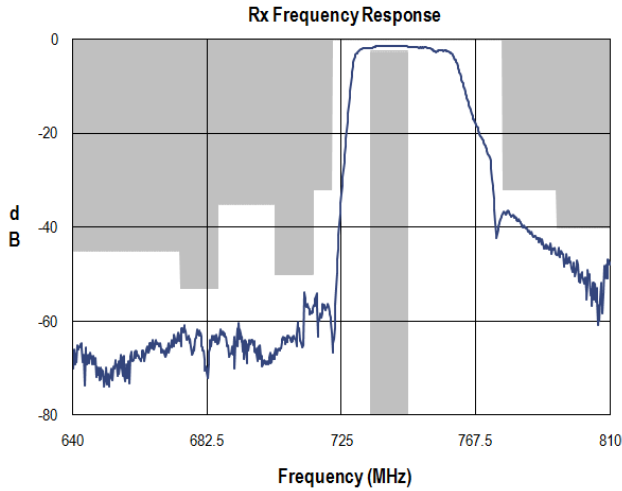

**Rx Path - Ant Port Impedance**

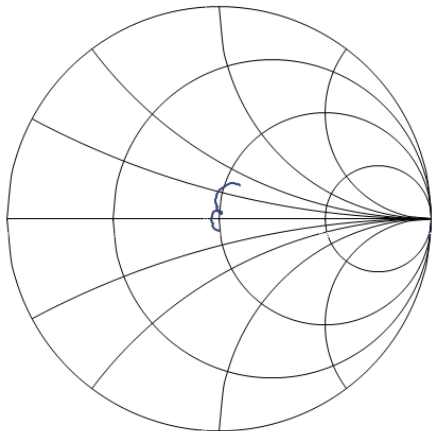

**Rx Port Impedance**

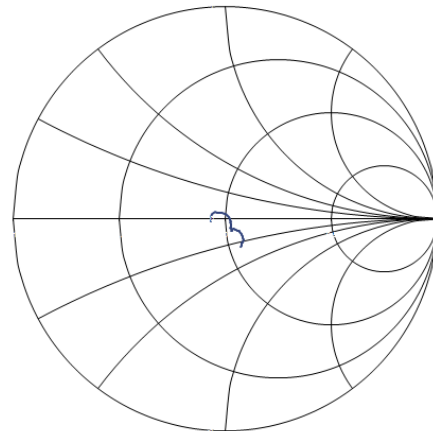

**Rx - Typical Performance (at room temperature)**

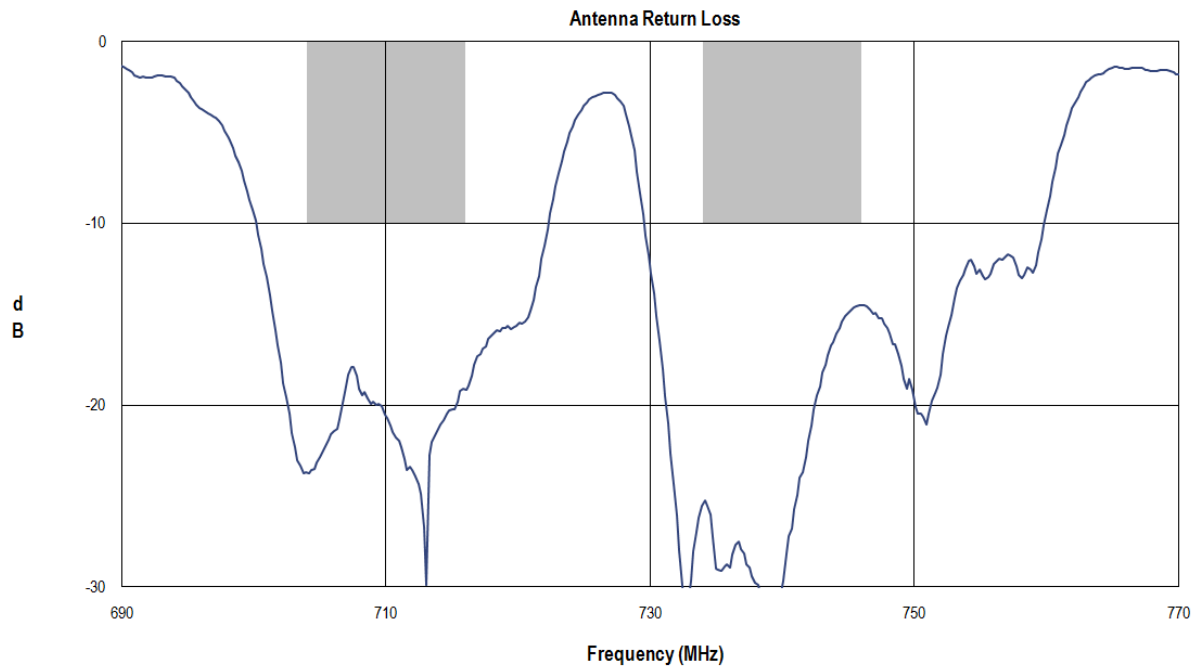
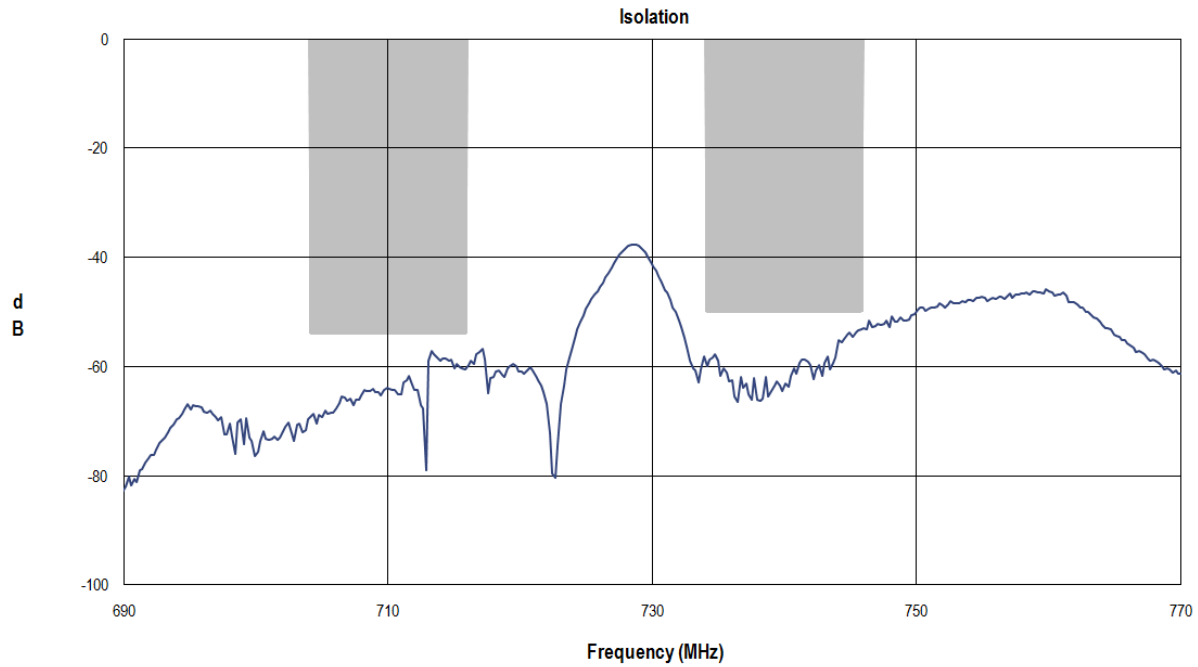

**Mechanical Information**

**Package Information, Dimensions and Marking**

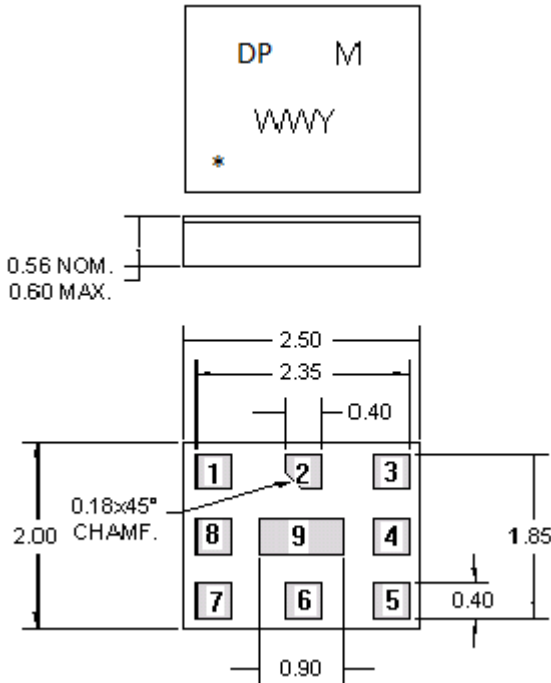

Package Style: CSP-10KT  
 Dimensions: 2.5 x 2.00 x 0.56 mm

Body:  $Al_2O_3$  ceramic  
 Lid: Kovar or Alloy 42, Au over Ni plated  
 Terminations: Au plating 0.5 - 1.0 $\mu$ m, over a 2-6 $\mu$ m Ni plating

All dimensions shown are nominal in millimeters  
 All tolerances are  $\pm 0.15$ mm except overall length and width  $\pm 0.10$ mm

The date code consists of: WW = 2 digit week,  
 Y = last digit of year, M = manufacturing site code

**Tape and Reel Information**

Standard T/R size = 10,000 units/reel. All dimensions are in millimeters

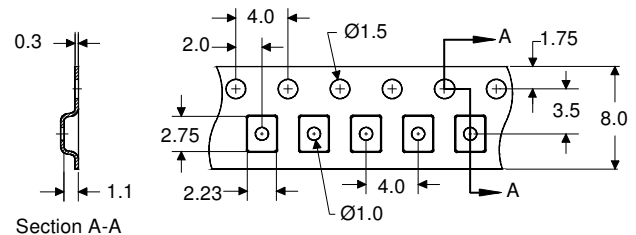
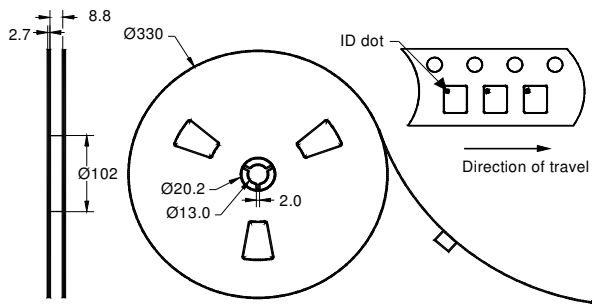

**Absolute Maximum Ratings**

Parameter	Rating
Operating Temperature	-20 to +90 °C
Storage Temperature	-40 to +90 °C
Input Power <sup>(1)</sup> at TX	+29 dBm

1. 55°C equivalent 5000 hours. All ports matched to 50 Ohms.

Operation of this device outside the parameter ranges given above may cause permanent damage.



## Product Compliance Information

### ESD Information



#### Caution! ESD-Sensitive Device

ESD Rating: Class 0

Value: Passes  $\leq 150$  V min.  
Test: Human Body Model (HBM)  
Standard: JEDEC Standard JESD22-A114

ESD Rating: Class A

Value: Passes  $\leq 150$  V min.  
Test: Machine Model (MM)  
Standard: JEDEC Standard JESD22-A115

### MSL Rating

Devices are Hermetic, therefore MSL is not applicable.

### Solderability

Compatible with the latest version of J-STD-020, lead free solder, 260°C

Refer to [Soldering Profile](#) for recommended guidelines.

This part is compliant with EU 2002/95/EC RoHS directive (Restrictions on the Use of Certain Hazardous Substances in Electrical and Electronic Equipment).

This product also has the following attributes:

- Halogen Free (Chlorine, Bromine)
- Antimony Free
- TBBP-A (C<sub>15</sub>H<sub>12</sub>Br<sub>4</sub>O<sub>2</sub>) Free
- PFOS Free
- SVHC Free

## Contact Information

For the latest specifications, additional product information, worldwide sales and distribution locations, and information about TriQuint:

**Web:** [www.triquint.com](http://www.triquint.com)      **Tel:** +1.407.886.8860  
**Email:** [info-sales@tqs.com](mailto:info-sales@tqs.com)      **Fax:** +1.407.886.7061

For technical questions and application information:

**Email:** [flapplication.engineering@tqs.com](mailto:flapplication.engineering@tqs.com)

## Important Notice

The information contained herein is believed to be reliable. TriQuint makes no warranties regarding the information contained herein. TriQuint assumes no responsibility or liability whatsoever for any of the information contained herein. TriQuint assumes no responsibility or liability whatsoever for the use of the information contained herein. The information contained herein is provided "AS IS, WHERE IS" and with all faults, and the entire risk associated with such information is entirely with the user. All information contained herein is subject to change without notice. Customers should obtain and verify the latest relevant information before placing orders for TriQuint products. The information contained herein or any use of such information does not grant, explicitly or implicitly, to any party any patent rights, licenses, or any other intellectual property rights, whether with regard to such information itself or anything described by such information.

TriQuint products are not warranted or authorized for use as critical components in medical, life-saving, or life-sustaining applications, or other applications where a failure would reasonably be expected to cause severe personal injury or death.