

Features

- Epitaxial Planar Die Construction
- Ideal for Medium Power Amplification and Switching
- High Current Gain
- Ultra-Small Surface Mount Package
- Also Available in Lead Free Version

Mechanical Data

- Case: SOT-323, Molded Plastic
- Case Material - UL Flammability Rating 94V-0
- Moisture sensitivity: Level 1 per J-STD-020A
- Terminals: Solderable per MIL-STD-202, Method 208
- Also Available in Lead Free Plating (Matte Tin Finish). Please see Ordering Information, Note 4, on Page 2
- Terminal Connections: See Diagram
- Marking (See Page 2): K1D
- Ordering & Date Code Information: See Page 2
- Weight: 0.006 grams (approx.)

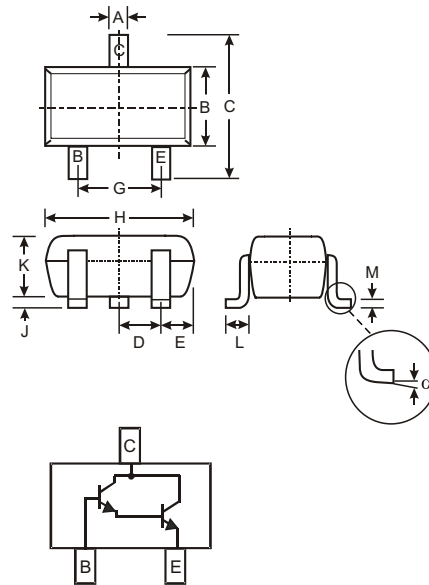

SOT-323		
Dim	Min	Max
A	0.25	0.40
B	1.15	1.35
C	2.00	2.20
D	0.65 Nominal	
E	0.30	0.40
G	1.20	1.40
H	1.80	2.20
J	0.0	0.10
K	0.90	1.00
L	0.25	0.40
M	0.10	0.18
α	0°	8°
All Dimensions in mm		

Maximum Ratings @ $T_A = 25^\circ\text{C}$ unless otherwise specified

Characteristic	Symbol	Value	Unit
Collector-Base Voltage	V_{CBO}	40	V
Collector-Emitter Voltage	V_{CEO}	40	V
Emitter-Base Voltage	V_{EBO}	12	V
Collector Current - Continuous (Note 1)	I_C	500	mA
Power Dissipation (Note 1)	P_d	200	mW
Thermal Resistance, Junction to Ambient (Note 1)	$R_{\theta JA}$	625	$^\circ\text{C/W}$
Operating and Storage and Temperature Range	T_j, T_{STG}	-55 to +150	$^\circ\text{C}$

Note: 1. Device mounted on FR-4 PCB, 1 inch x 0.85 inch x 0.062 inch; pad layout as shown on Diodes Inc. suggested pad layout document AP02001, which can be found on our website at <http://www.diodes.com/datasheets/ap02001.pdf>.

Electrical Characteristics @ T_A = 25°C unless otherwise specified

Characteristic	Symbol	Min	Max	Unit	Test Condition
OFF CHARACTERISTICS (Note 2)					
Collector-Base Breakdown Voltage	V _{(BR)CBO}	40	—	V	I _C = 100μA, I _E = 0
Collector-Emitter Breakdown Voltage	V _{(BR)CEO}	40	—	V	I _C = 100mA, I _B = 0
Emitter-Base Breakdown Voltage	V _{(BR)EBO}	12	—	V	I _E = 10μA, I _C = 0
Collector Cutoff Current	I _{CBO}	—	50	nA	V _{CB} = 30V, I _E = 0
Collector Cutoff Current	I _{CEO}	—	1.0	μA	V _{CE} = 25V, I _B = 0
Emitter Cutoff Current	I _{EBO}	—	50	nA	V _{EB} = 10V, I _C = 0
ON CHARACTERISTICS (Note 2)					
DC Current Gain	h _{FE}	10,000 20,000 14,000	100,000 200,000 140,000	—	I _C = 10mA, V _{CE} = 5.0V I _C = 100mA, V _{CE} = 5.0V I _C = 500mA, V _{CE} = 5.0V
Collector-Emitter Saturation Voltage	V _{CE(SAT)}	—	1.2 1.5	V	I _C = 50mA, I _B = 0.5mA I _C = 500mA, I _B = 0.5mA
Base-Emitter Saturation Voltage	V _{BE(SAT)}	—	2.0	V	I _C = 500mA, I _B = 0.5mA
Base-Emitter On Voltage	V _{BE(ON)}	—	1.75	V	I _C = 50mA, V _{CE} = 5.0V
SMALL SIGNAL CHARACTERISTICS					
Output Capacitance	C _{obo}	8.0 Typical		pF	V _{CB} = 10V, f = 1.0MHz, I _E = 0
Input Capacitance	C _{ibo}	15 Typical		pF	V _{EB} = 0.5V, f = 1.0MHz, I _C = 0

Ordering Information (Note 3)

Device	Packaging	Shipping
MMST6427-7	SOT-323	3000/Tape & Reel

- Notes:
2. Short duration test pulse used to minimize self-heating effect.
 3. For Packaging Details, go to our website at <http://www.diodes.com/datasheets/ap02007.pdf>.
 4. For Lead Free version (with Lead Free terminal finish) part number, please add "-F" suffix to part number above.
Example: MMST6427-7-F.

Marking Information

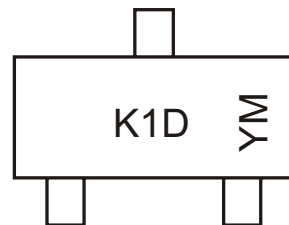

K1D= Product Type Marking Code
 YM = Date Code Marking
 Y = Year ex: N = 2002
 M = Month ex: 9 = September

Date Code Key

Year	1998	1999	2000	2001	2002	2003	2004	2005	2006	2007	2008	2009
Code	J	K	L	M	N	P	R	S	T	U	V	W

Month	Jan	Feb	March	Apr	May	Jun	Jul	Aug	Sep	Oct	Nov	Dec
Code	1	2	3	4	5	6	7	8	9	O	N	D

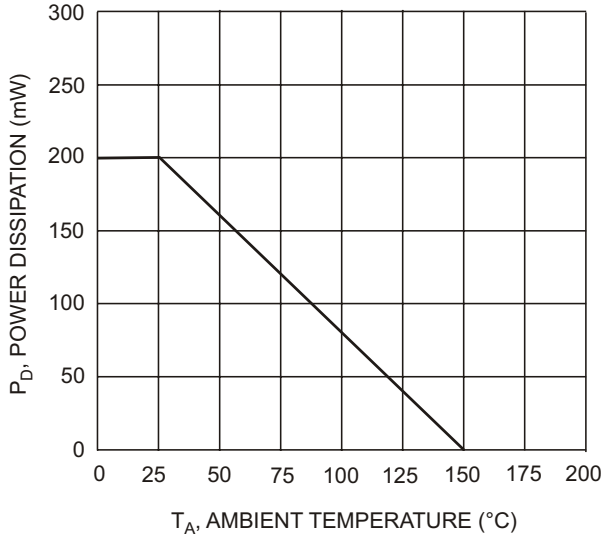

T_A , AMBIENT TEMPERATURE ($^{\circ}C$)
Fig. 1, Max Power Dissipation vs Ambient Temperature

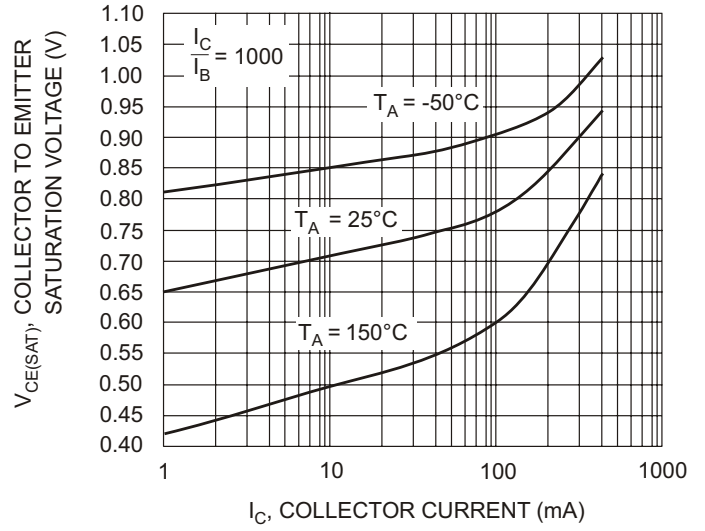

I_C , COLLECTOR CURRENT (mA)
Fig. 2, Collector Emitter Saturation Voltage vs. Collector Current

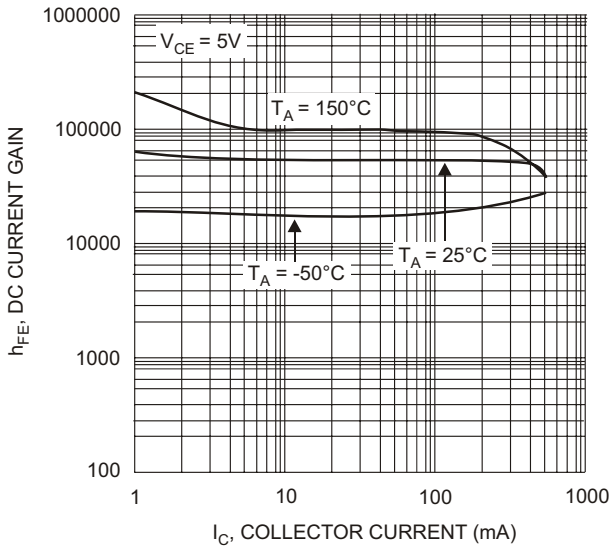

I_C , COLLECTOR CURRENT (mA)
Fig. 3, DC Current Gain vs Collector Current

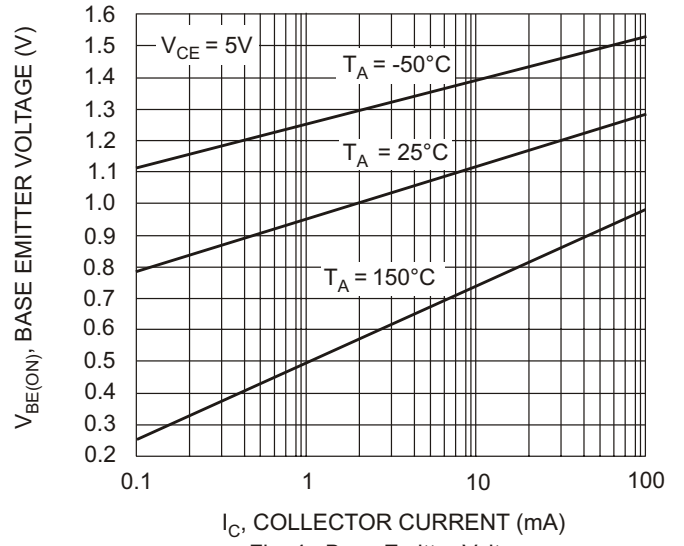

I_C , COLLECTOR CURRENT (mA)
Fig. 4, Base Emitter Voltage vs. Collector Current

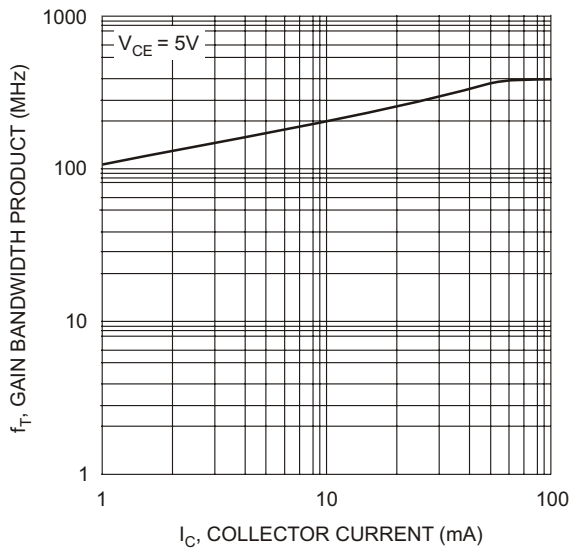

I_C , COLLECTOR CURRENT (mA)
Fig. 5, Gain Bandwidth Product vs Collector Current