

## LQ084V3DG01 TFT-LCD Module

### Product Specification

August 2007

Strong 2 VGA LCD Module featuring  
400 nits brightness with 600:1 contrast.

Full Specifications Listing

PREPARED BY:	<b>SHARP</b>	SPEC No. LCY-W07805
APPROVED BY:		FILE No.
		ISSUED: Aug.14.2007
		PAGE : 20pages
	MOBILE LIQUID CRYSTAL DISPLAY GROUP SHARP CORPORATION <b>SPECIFICATION</b>	APPLICABLE GROUP MOBILE LIQUID CRYSTAL DISPLAY GROUP

DEVICE SPECIFICATION FOR  
  
**TFT-LCD module**  
  
 MODEL No. LQ084V3DG01

These parts have corresponded with the RoHS directive.

CUSTOMER'S APPROVAL

DATE \_\_\_\_\_

BY \_\_\_\_\_

PRESENTED

BY

K. YAMAMOTO

General Manager

Mobile LCD Merchandise Design Center

WUXI SHARP ELECTRONIC COMPONENTS CO., LTD.

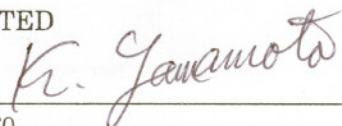



**NOTICE**

This publication is the proprietary of SHARP and is copyrighted, with all rights reserved. Under the copyright laws, no part of this publication may be reproduced or transmitted in any form or by any means, electronic or mechanical for any purpose, in whole or in part, without the express written permission of SHARP. Express written permission is also required before any use of this publication may be made by a third party.

The application circuit examples in this publication are provided to explain the representative applications of SHARP's devices and are not intended to guarantee any circuit design or permit any industrial property right or other rights to be executed. SHARP takes no responsibility for any problems related to any industrial property right or a third party resulting from the use of SHARP's devices, except for those resulting directly from device manufacturing processes.

In the absence of confirmation by device specification sheets, SHARP takes no responsibility for any defects that occur in equipment using any of SHARP's devices, shown in catalogs, data books, etc. Contact SHARP in order to obtain the latest device specification sheets before using any SHARP's device.

SHARP reserves the right to make changes in the specifications, characteristics, data, materials, structures and other contents described herein at any time without notice in order to improve design or reliability. Contact SHARP in order to obtain the latest specification sheets before using any SHARP's device. Manufacturing locations are also subject to change without notice.

Observe the following points when using any device in this publication. SHARP takes no responsibility for damage caused by improper use of the devices.

The devices in this publication are designed for general electronic equipment use.

The appropriate design measures should be taken to ensure reliability and safety when SHARP's devices are used for equipment such as:

- Transportation control and safety equipment(i.e.,aircraft, trains, automobiles, etc.)
- Traffic signals • Gas leakage sensor breakers • Alarm equipment • Various safety devices etc.

SHARP's devices shall not be used for equipment that requires extremely high level of reliability, such as:

- Military and space applications      • Nuclear power control equipment
- Medical equipment for life support

Contact a SHARP representative, in advance, when intending to use SHARP's devices for any "specific" applications other than those recommended by SHARP.

Contact and consult with a SHARP representative if there are any questions about the contents of this publication.

## 1 Applicable TFT-LCD module

This specification applies to the color TFT-LCD module, LQ084V3DG01.

## 2 Overview

This module is a color active matrix transmissive LCD module incorporating amorphous silicon TFT (Thin Film Transistor).

It is composed of a color TFT-LCD panel, driver ICs, control circuits and power supply circuitry and a backlight unit. Graphics and texts can be displayed on a 640 x RGB x 480 dots panel with 262,144 colors by feeding 18 bit data signal (6bit/each of R,G,B), 4(four) timing signals, +3.3V DC power supply for TFT-LCD and AC power supply for backlight.

(Note: Backlight-driving DC/AC inverter is not built in this module.)

- Fine images with stripe aligned 307,200 pixels on 8.4 inch diagonal screen
- Adapting a wide viewing angle technology [best viewing angle: 6 o'clock direction]
- High contrast, thanks to active matrix drive system
- AG(Anti Glare) polarizing filter
- Light and slim compact module (12 o'clock direction is also available by the function to flip the screen horizontally or vertically)
- Natural coloring reproducibility by employing normally-white-mode, which has good nature in coloring
- Image inversion both horizontally and vertically
- This module is adapted to RoHS compliance.

## 3 Mechanical Specifications

items	specifications	unit
Display size (Diagonal)	21.4 (8.4")	cm
Active display area	170.88 (H) x 128.16 (V)	mm
Pixel format	640(H) x RGB x 480(V)	dot
	(1 pixel=R+G+B dots)	-
Pixel pitch	0.267 (H) x 0.267(V)	mm
Pixel configuration	R,G,B vertical stripe	-
LCD mode	Normally white/Twisted Nematic	-
Dimension *	199.5 (W) x 149.5 (H) x 11.6(D)	mm
Mass	400 (max)	g

\*. Protrusion such as backlight harness is not included.

Fig.1 shows dimensions of the module.

## 4 Input Signal Assignment

### 4.1 TFT-LCD Panel driving section

CN1                      Used connector: IMSA-9637S-33Y902 (IRISO ELECTRONICS CO.,LTD.)

Pin No.	Symbol	Function	Polarity
1	GND	—	
2	CK	Clock signal for sampling each datum	
3	Hsync	Horizontal Sync signal	Negative
4	Vsync	Vertical Sync signal	Negative
5	GND		
6	R0	RED Data signal (LSB)	
7	R1	RED Data signal	
8	R2	RED Data signal	
9	R3	RED Data signal	
10	R4	RED Data signal	
11	R5	RED Data signal (MSB)	
12	GND		
13	G0	GREEN data signal (LSB)	
14	G1	GREEN data signal	
15	G2	GREEN data signal	
16	G3	GREEN data signal	
17	G4	GREEN data signal	
18	G5	GREEN data signal (MSB)	
19	GND		
20	B0	BLUE data signal (LSB)	
21	B1	BLUE data signal	
22	B2	BLUE data signal	
23	B3	BLUE data signal	
24	B4	BLUE data signal	
25	B5	BLUE data signal (MSB)	
26	GND		
27	ENAB	Data Enable signal (Control signal for image location in horizontal direction)	[Note 4-1]
28	Vcc	Power supply in	
29	Vcc	Power supply in	
30	R/L	Horizontal scanning direction control signal (Rightwards/Leftwards)	[Note 4-2]
31	U/D	Vertical scanning direction control signal (Upwards/downwards)	[Note 4-2]
32	NC		
33	GND		

The front shield case and back shield case is internally grounded to GND of the module.

[Note 4-1]

The horizontal display location is designated and controlled by rising timing of ENAB signal.

However if ENAB signal is fixed to “Low”, display location is designated by the default setting in the module.

(Don't use the module by fixing ENAB to “High”) .....See: Chapter 7-2

[Note 4-2]

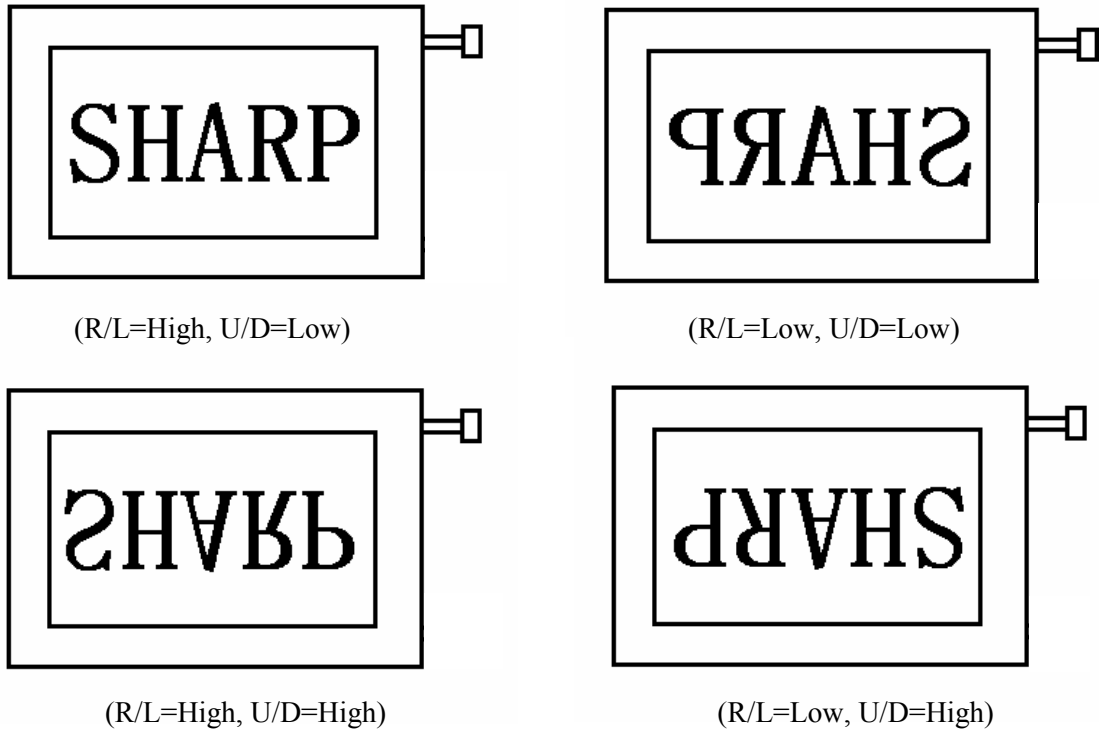

4.2 Backlight section

Employed connector: BHR-04VS-1 (JST)

Adapted connector: SM04 (4.0) B-BHS (JST)

CN2

Pin no.	Symbol	Function
1	V <sub>HIGH</sub>	Power supply for lamp (High voltage side)
2	V <sub>HIGH</sub>	Power supply for lamp (High voltage side)
3	NC	This is electrically opened.
4	V <sub>LOW</sub>	Power supply for lamp (Low voltage side)

**【Note】**

The input voltage wave forms to terminal ① and terminal ② should be in a same phase.

It has the possibility to discharge abnormally between the terminals in case of input in a reversed phase.

5 Absolute Maximum Ratings

Parameter	Symbol	Condition	Ratings	Unit	Remark
Input voltage	V <sub>I</sub>	Ta=25°C	-0.3 ~ V <sub>cc</sub> +0.3	V	[Note 5-1]
Supply voltage	V <sub>cc</sub>	Ta=25°C	0 ~ +4.0	V	-
Storage temperature	T <sub>stg</sub>	-	-30 ~ +80	°C	[Note 5-2,3,4]
Operating temperature (Panel surface)	T <sub>opp</sub>	-	-30 ~ +80	°C	

[Note 5-1] CK, R0 ~ R5, G0 ~ G5, B0 ~ B5, Hsync, Vsync, ENAB, R/L and U/D

[Note 5-2] Humidity: Less than 95%RH at Ta ≤ 40°C and

Maximum wet-bulb temperature must not exceed 39°C at Ta>40°C, with no condensation.

[Note 5-3] The operating temperature only guarantees operation of the circuit. For contrast, speed response, and other factors related to display quality, judgment is done using the ambient temperature Ta = +25°C.

[Note 5-4] This rating applies to all parts of the module and should not be exceeded.

6 Electrical characteristics

6.1 TFT-LCD Panel driving section

Ta = 25°C

Parameter	Symbol	Min	Typ	Max	Unit	Remarks
Supply voltage	V <sub>CC</sub>	+3.0	+3.3	+3.6	V	[Note6-1]
Current dissipation	I <sub>CC</sub>	-	200	360	mA	[Note6-2]V <sub>CC</sub> =3.3V
Allowed input ripple voltage	V <sub>RF</sub>	-	-	100	mV p-p	
Input voltage (“Low” state)	V <sub>IL</sub>	-	-	0.8	V	[Note6-3]
Input voltage (“High” state)	V <sub>IH</sub>	2.1	-	-	V	
Input leakage current (low)	I <sub>OL1</sub>	-10.0	-	10.0	μA	V <sub>I</sub> =0V [Note6-4]
	I <sub>OL2</sub>	-800	-	-	μA	V <sub>I</sub> =0V [Note6-5]
	I <sub>OL3</sub>	-10.0	-	10.0	μA	V <sub>I</sub> =0V [Note6-6]
Input leakage current (High)	I <sub>OH1</sub>	-10.0	-	10.0	μA	V <sub>I</sub> =V <sub>CC</sub> [Note6-4]
	I <sub>OH2</sub>	-10.0	-	10.0	μA	V <sub>I</sub> =V <sub>CC</sub> [Note6-5]
	I <sub>OH3</sub>	-	-	800	μA	V <sub>I</sub> =V <sub>CC</sub> [Note6-6]

[Note6-1] V<sub>CC</sub> turn-on/off conditions

- 0 < t<sub>1</sub> ≤ 15ms
- 0 < t<sub>2</sub> ≤ 10ms
- 0 < t<sub>3</sub> ≤ 100ms
- 0 < t<sub>4</sub> ≤ 1s
- t<sub>5</sub> > 200ms

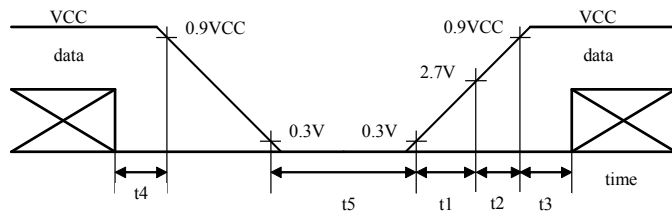

V<sub>CC</sub>-dip conditions

- 1) At 2.5V ≤ V<sub>CC</sub>  
t<sub>d</sub> ≤ 10ms
- 2) At V<sub>CC</sub> < 2.5V  
V<sub>CC</sub> dip conditions should also follow the V<sub>CC</sub> turn-on/off conditions

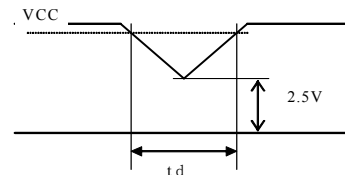

[Note6-2] Current dissipation (Typ.):

When Monochrome 16 level-gray-bar pattern is displayed (Figure below, Refer Page 10 for details of RGB)

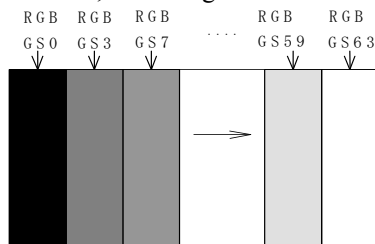

Current dissipation(Max):

When VS(V63) and V0 stripe pattern are displayed alternately at intervals of two lines. (Figure below, Refer Page 10 for details of RGB)

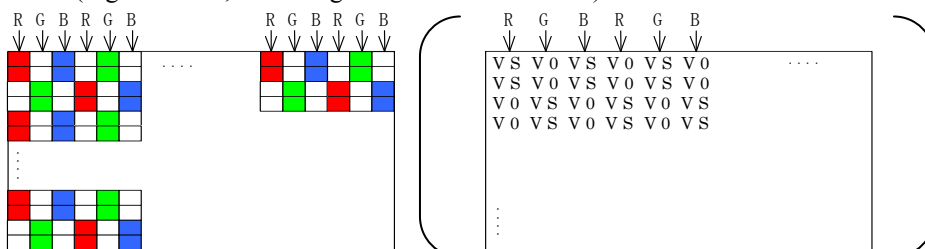



[Note6-3] CK, R0~R5, G0~G5, B0~B5, Hsync, Vsync, ENAB, R/L and U/D

[Note6-4] CK, R0~R5, G0~G5, B0~B5, Hsync, Vsync, and ENAB

[Note6-5] R/L

[Note6-6] U/D

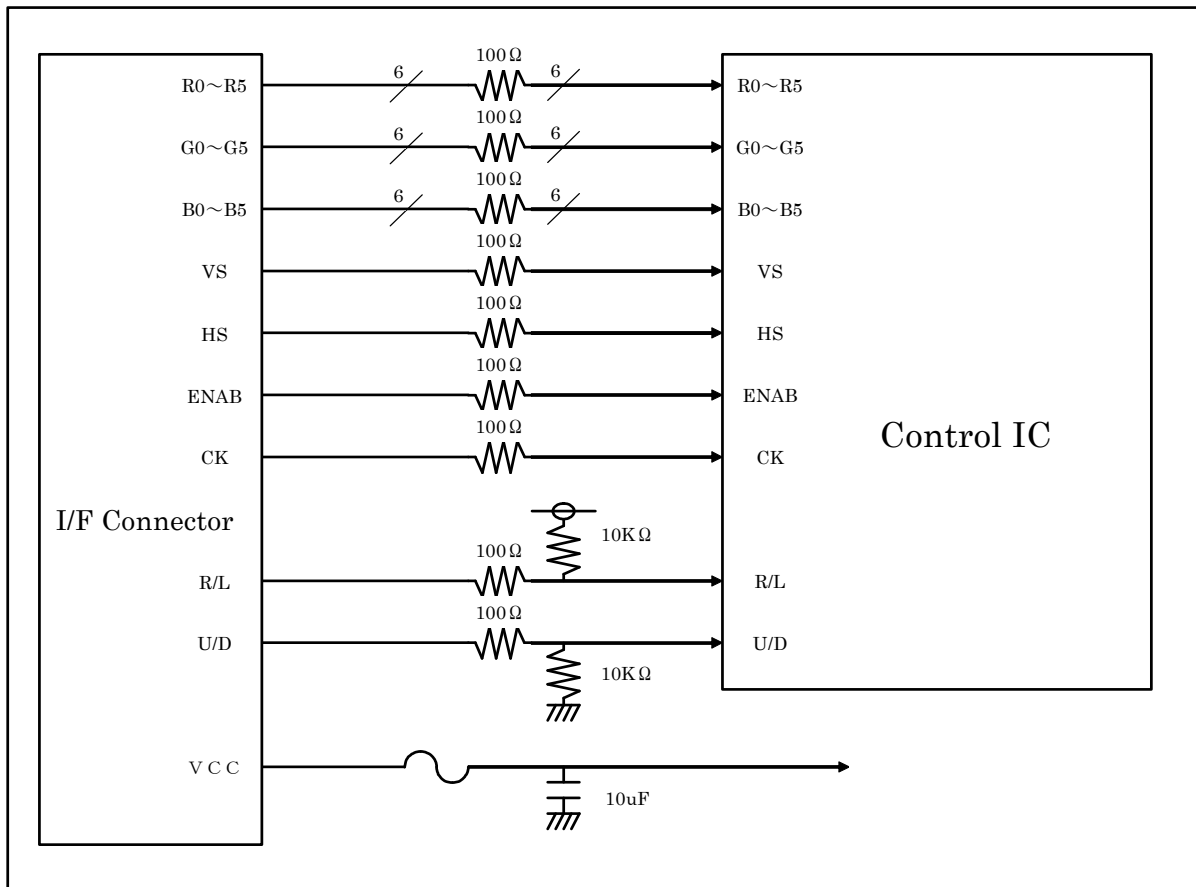

## 6.2 Backlight driving Section

The backlight system is an edge-lighting type with two CCFTs (Cold Cathode Fluorescent Tube).

The characteristics of single lamp are shown in the following table.

※Recommended inverter(TDK : CXA-0463)

Ta=25°C

Parameter	Symbol	Min.	Typ.	Max.	Unit	Remarks
Lamp voltage	VL	380	420	460	V rms	IL=6mA rms
Lamp current	IL	3.0	6.0	6.5	mA rms	[Note6-7]
Lamp power consumption	PL	-	2.5	-	W	
Lamp frequency	fL	50	-	80	KHz	Recommend 55kHz
Kick-off voltage [Note6-1]	Vs	-	-	890	V rms	Ta=25°C [Note6-8]
		-	-	1070		Ta=-30°C [Note6-8]
Lamp life time	LL	-	50,000	-	hour	[Note6-9]

[Note6-7] Lamp current is measured with current meter for high frequency as shown below.

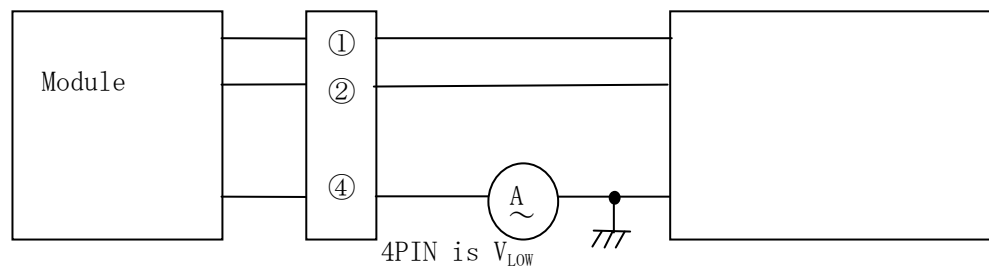

[Note6-8] The open output voltage of the inverter shall be maintained for more than 1sec;

otherwise the lamp may not be turned on.

The input voltage wave forms to terminal ① and terminal ② should be in a same phase. It has the possibility to discharge abnormally between the terminals in case of input of a reversed phase.

For the sake of the safety, please so design the inveter as to prevent abnormal discharge when one of the two lamps is broken or reaches the end of life.

[Note6-9] The data for lamp is for your reference, because lamp is consumable component.

a) Lamp life time is defined by either 1or 2 below. (Continuous turning on at Ta=25°C, IL=6mA rms)

① When a brightness of lamp surface became 50% of the initial value under the standard condition.

② When a kick-off voltage in Ta= -30°C exceeded maximum value ((1070) Vrms) at the output of inverter circuitry

b) In case of operating under lower temp. environment, the lamp exhaustion is accelerated and the brightness becomes lower.

(Continuous operating for around 1 month under lower temp. condition may reduce the brightness to half of the original brightness.)

In case of such usage under lower temp. environment, periodical lampexchange is recommended

[Note] The performance of the backlight, for example life time or brightness, is much influenced by the characteristics of the DC-AC inverter for the lamp. When you design or order the inverter, please make sure that an inadequate lighting caused by the mismatch of the backlight and the inverter (miss-lighting, flicker, etc.) never occur. When you confirm it, the module should be operated in the same condition as it is installed in your instrument.

## 7 Timing Characteristics of Input Signals

Timing diagrams of input signal are shown in Fig.2.

### 7.1 Timing Characteristics

Parameter	Symbol	Min.	Typ.	Max.	Unit	Remark	
Clock	Frequency	1/Tc	-	25.18	28.33	MHz	
	“High” time	Tch	5	-	-	ns	
	“Low” time	Tcl	10	-	-	ns	
Data	Setup time	Tds	5	-	-	ns	
	Hold time	Tdh	10	-	-	ns	
Hsync	Period	TH	30.00	31.78		μs	
			750	800	900	clock	
	Pulse width	THp	2	96	200	clock	
Vsync	Period	TV	515	525	560	line	
	Frequency	1/Tv	50	60	-	Hz	[Note7-1]
	Pulse width	TVp	1	-	34	line	
Horizontal display period	THd	640	640	640	clock		
Phase difference between Hsync and clock	THc	10	-	Tc-10	ns		
Phase difference between Hsync and Vsync	TVh	0	-	TH-THp	clock		
Vertical display period	TVs	34	34	34	line		

Note7-1) In case of lower frequency, the deterioration of display quality, flicker etc., may occur.

Please use this module in more than 50Hz.(1/Tv)

### 7.2 Display Position in horizontal direction

Display position in horizontal direction is designated by rising timing of ENAB signal.

Parameter	Symbol	MIN	TYP	MAX	Unit	Note
ENAB signal	Setup time	Tes	5	-	Tc -10	ns
	Pulse width	Tep	2	640	TH-10	clock
Phase difference between Hsync and ENAB signal	THE	44	-	TH-664	clock	

When ENAB is fixed to “Low”, the horizontal display will starts from the clock C104 (clock) as shown in Fig.2. When the phase difference is not greater than 104 clock, hold ENAB terminal in “High” state for more than (104-THe), otherwise display will start from C104 (clock).

### 7.3 Display position in vertical direction

Display start position in vertical direction is fixed to the 34th line.

### 7.4 Input signal and display on the screen

Display position of input data

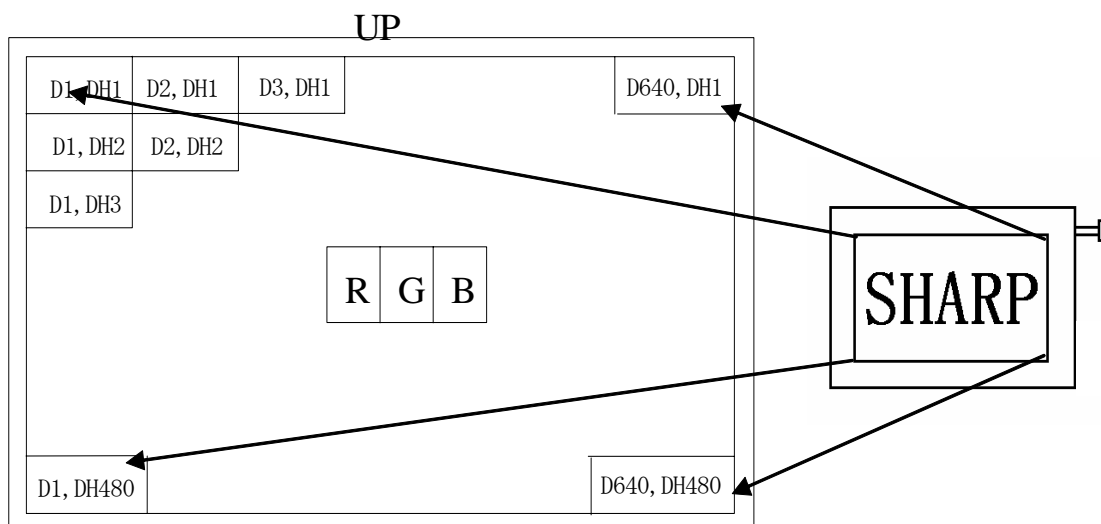

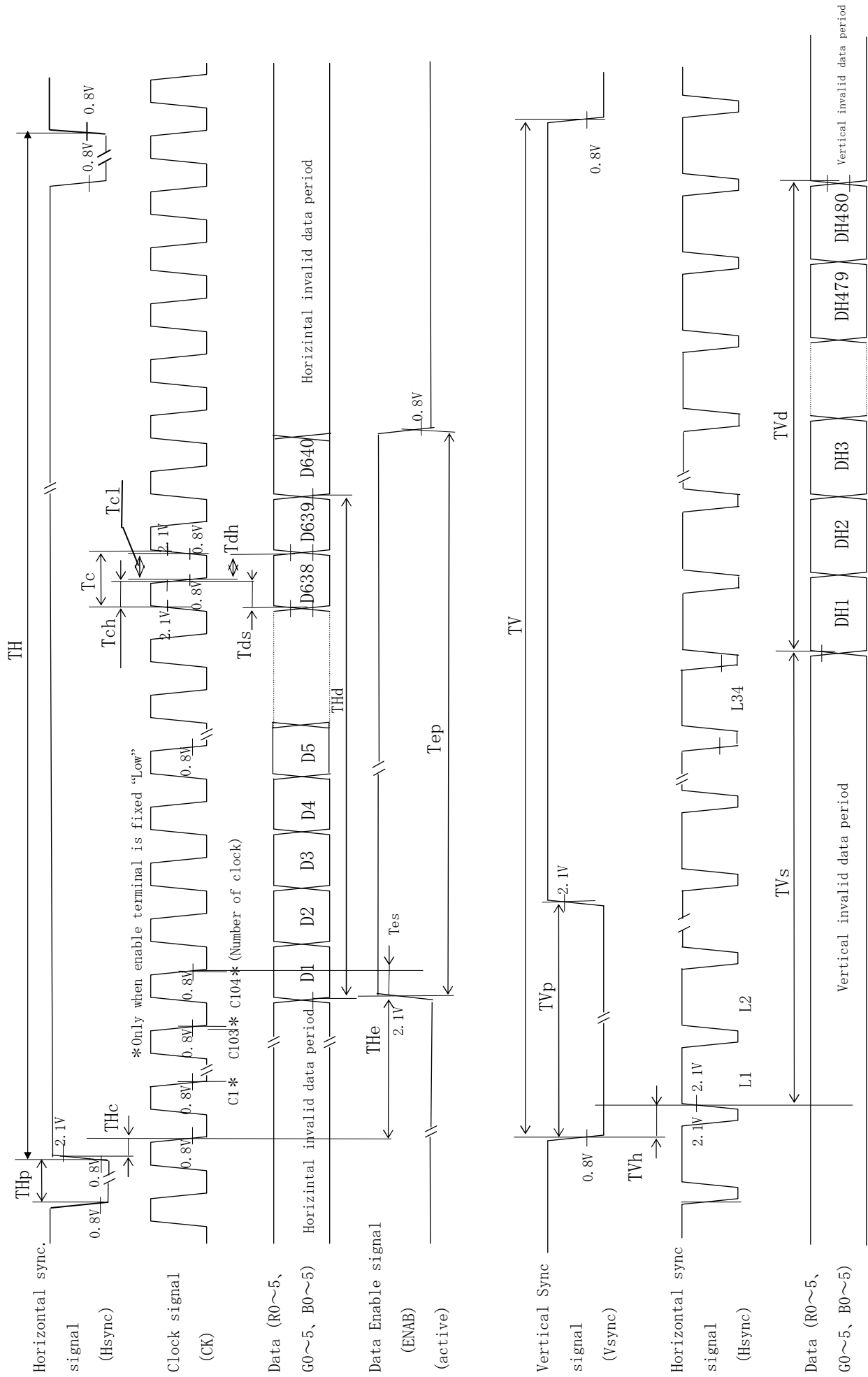

Fig 2. Input signal waveforms

8 Input Signals, Basic Display Colors and Gray Scale of Each Color

	Colors & Gray scale	Data signal																		
		Gray Scale	R0	R1	R2	R3	R4	R5	G0	G1	G2	G3	G4	G5	B0	B1	B2	B3	B4	B5
Basic Color	Black	-	0	0	0	0	0	0	0	0	0	0	0	0	0	0	0	0	0	0
	Blue	-	0	0	0	0	0	0	0	0	0	0	0	0	1	1	1	1	1	1
	Green	-	0	0	0	0	0	0	1	1	1	1	1	1	0	0	0	0	0	0
	Cyan	-	0	0	0	0	0	0	1	1	1	1	1	1	1	1	1	1	1	1
	Red	-	1	1	1	1	1	1	0	0	0	0	0	0	0	0	0	0	0	0
	Magenta	-	1	1	1	1	1	1	0	0	0	0	0	0	1	1	1	1	1	1
	Yellow	-	1	1	1	1	1	1	1	1	1	1	1	1	0	0	0	0	0	0
	White	-	1	1	1	1	1	1	1	1	1	1	1	1	1	1	1	1	1	1
Gray Scale of Red	Black	GS0	0	0	0	0	0	0	0	0	0	0	0	0	0	0	0	0	0	0
	↑	GS1	1	0	0	0	0	0	0	0	0	0	0	0	0	0	0	0	0	0
	Darker	GS2	0	1	0	0	0	0	0	0	0	0	0	0	0	0	0	0	0	0
	↑	↓				↓					↓					↓				
	↓	↓				↓					↓					↓				
	Brighter	GS61	1	0	1	1	1	1	0	0	0	0	0	0	0	0	0	0	0	0
	↓	GS62	0	1	1	1	1	1	0	0	0	0	0	0	0	0	0	0	0	0
	Red	GS63	1	1	1	1	1	1	0	0	0	0	0	0	0	0	0	0	0	0
Gray Scale of Green	Black	GS0	0	0	0	0	0	0	0	0	0	0	0	0	0	0	0	0	0	0
	↑	GS1	0	0	0	0	0	0	1	0	0	0	0	0	0	0	0	0	0	0
	Darker	GS2	0	0	0	0	0	0	0	1	0	0	0	0	0	0	0	0	0	0
	↑	↓				↓					↓					↓				
	↓	↓				↓					↓					↓				
	Brighter	GS61	0	0	0	0	0	0	1	0	1	1	1	1	0	0	0	0	0	0
	↓	GS62	0	0	0	0	0	0	0	1	1	1	1	1	0	0	0	0	0	0
	Green	GS63	0	0	0	0	0	0	1	1	1	1	1	1	0	0	0	0	0	0
Gray Scale of Blue	Black	GS0	0	0	0	0	0	0	0	0	0	0	0	0	0	0	0	0	0	0
	↑	GS1	0	0	0	0	0	0	0	0	0	0	0	0	1	0	0	0	0	0
	Darker	GS2	0	0	0	0	0	0	0	0	0	0	0	0	0	1	0	0	0	0
	↑	↓				↓					↓					↓				
	↓	↓				↓					↓					↓				
	Brighter	GS61	0	0	0	0	0	0	0	0	0	0	0	0	1	0	1	1	1	1
	↓	GS62	0	0	0	0	0	0	0	0	0	0	0	0	0	1	1	1	1	1
	Blue	GS63	0	0	0	0	0	0	0	0	0	0	0	0	1	1	1	1	1	1

0: Low level voltage, 1: High level voltage

Each basic color can be displayed in 64 gray scales from 6 bit data signals. According to the combination of total 18 bit data signals, the 262,144-color display can be achieved on the screen.

9 Optical Specification

Ta=25°C, Vcc=+3.3V

Parameter	Symbol	Condition	Min.	Typ.	Max.	Unit	Remark	
Viewing angle Range	Horizontal	CR≥10	50	65	-	° (Deg.)	[Note9-1,4]	
	Vertical		θ 11	40	55	-		° (Deg.)
			θ 12	45	60	-		° (Deg.)
Contrast ratio	CR max	Best viewing angle	400	600	-	-	[Note9-2]	
Response time	Rise	θ = 0°	-	5	15	ms	[Note9-3]	
	Fall		-	21	40	ms		
Chromaticity of white	x	IL=6mArms	0.263	0.313	0.363	-	[Note9-4]	
	y		0.279	0.329	0.379	-		
Luminance	Y		320	400	-	cd/m <sup>2</sup>		

The optical specifications are measured 30 minute after turning lamp on and in a dark room or equivalent condition, according to the method shown in below.

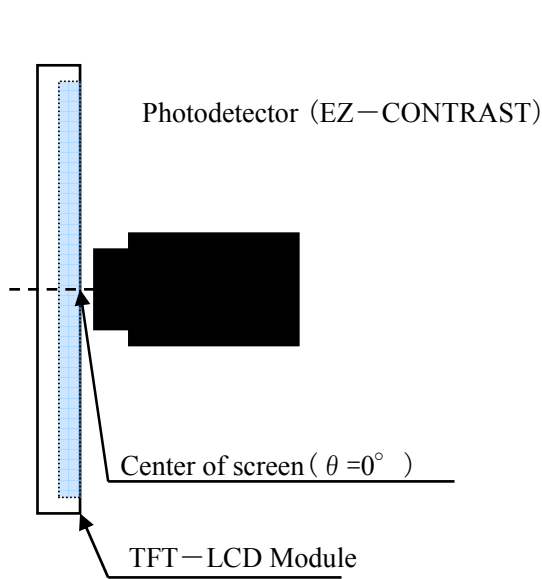

Fig2-1 Viewing angle measurement method

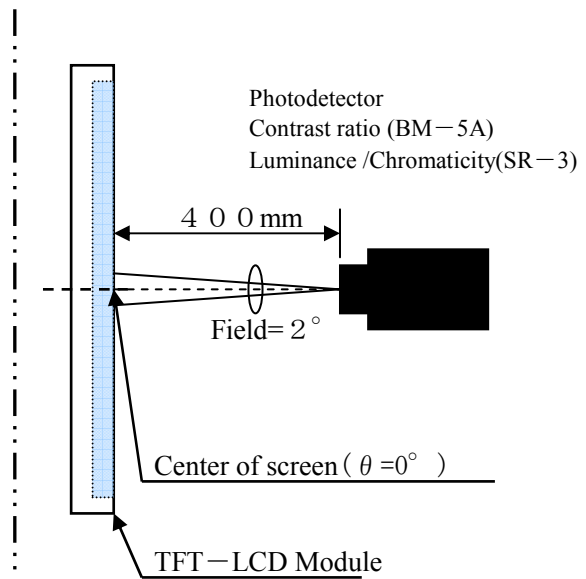
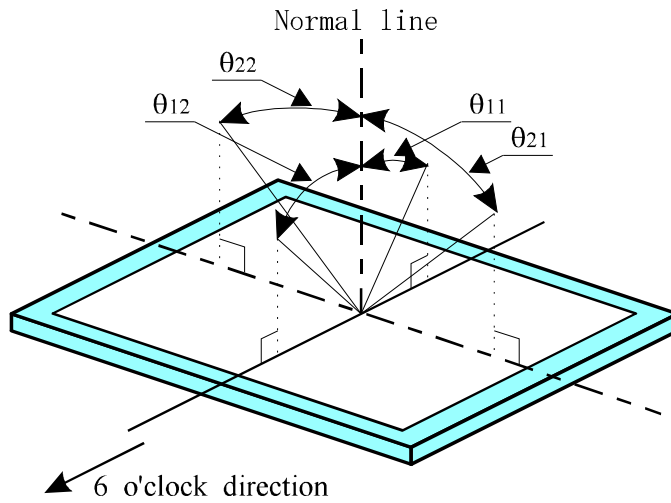

Fig2-2 Luminance/Contrast ratio/Response time/Chromaticity measurement method

Fig2 Optical characteristics measurement method

[Note9-1] Definitions of viewing angle range:



The best viewing angle of this module is slightly leaned to 6 o'clock from normal line. In the field where  $\theta_{12}$  exceeds this angle, gray-scale is reversed partially. The gray-scale in the field of 12 o'clock direction is brighter than that of 6 o'clock direction and isn't reversed.

[Note9-2] Definition of contrast ratio:

The contrast ratio is defined as the following.

$$\text{Contrast Ratio (CR)} = \frac{\text{Luminance (brightness) with all pixels white}}{\text{Luminance (brightness) with all pixels black}}$$

[Note9-3] Definition of response time:

The response time is defined as the following figure and shall be measured by switching the input signal between "black" and "white" alternatively.

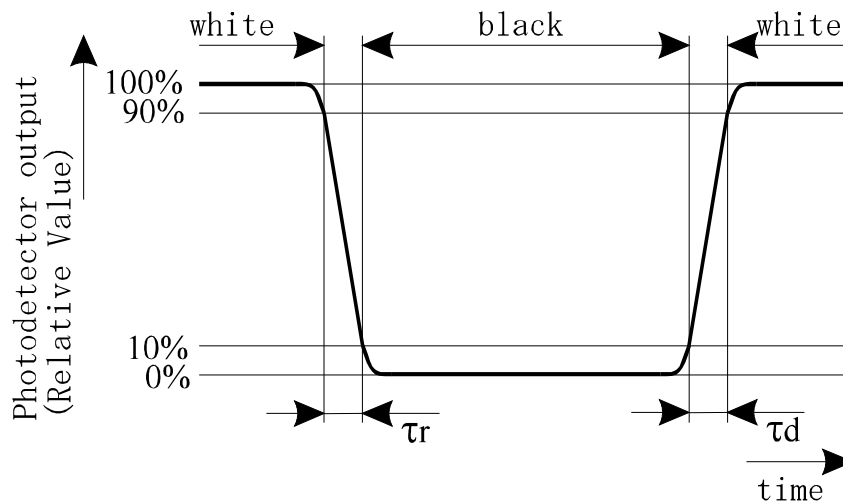

[Note9-4] This parameter should be measured at the center of the screen and 30 minutes after turn-on.

Inverter frequency: 55 kHz

The characteristics are measured when the driver circuit is not powered.

## 10 Display Qualities

Please refer to the Outgoing Inspection Standard.

## 11 Handling Instruction

### 11.1 Assembling the module

- 1) The TFT-LCD module is designed to be mounted on equipment using the mounting hole in the four corners of the module at the rear side. On mounting the module, as the nominal diameter 3.0mm tapping screw (fastening torque is  $0.45 \sim 0.60 \text{N} \cdot \text{m}$ ) is recommended, be sure to fix the module on the same plane, taking care not to wrap or twist the module.
- 2) Please power off the module before you connect or disconnect input connector.
- 3) Make sure to connect module's metal shield case to GND of inverter circuit. If its connection is not made perfectly, some of the following problems may occur.
  - a) Increase of noise caused by backlight
  - b) Unstable output from inverter circuit
  - c) Possibly over-heat in some section

### 11.2 Instruction for assembling

- 1) Since the front polarizer is easily damaged, pay attention to avoid rubbing with something hard or sharp.
- 2) How to eliminate dust on polarizer.
  - Blow dust away by  $\text{N}_2$  blower having measures of electrostatics
  - Since the front polarizer is easily damaged, wiping dust off is not adequate. If the polarizer is soiled, it is suggested to peel dust off by using adhesive surface of adhesive tape.
- 3) When the metal section [shield case or shield back case] is soiled, wipe it off with dry and soft cloth. If not so easy, breathe upon it then wipe off. If the water droplet or fat is left for long term, it may cause stain or tarnish, it should be wipe off immediately.
- 4) Since TFT-LCD panel is made of glass substrate, dropping the panel or banging it against hard objects may cause cracking or fragmentation.
- 5) Since CMOS LSIs are incorporated in this module, please pay special care to electrostatic while handling it, and earth human body.

### 11.3 Caution in product design

The notes and cautions below should be followed when product is designed with this module.

The module should be protected with cover to prevent salt content and/or water droplet.

Take enough shielding countermeasure not to interfere to peripheral electronic device.



11.4 Others

The LCD has the nature that its performance is degradation by ultra-violet light. Don't leave the LCD module in direct sunlight or strong ultra violet ray.

If stored at the temperatures lower than the rated storage temperature, the LC may freeze and it may cause LCD panel damage. If storage temperature exceeds the specified rating, the molecular orientation of the LC may change to that of a liquid, and they may not revert to their original state. Store the module in normal room temperature.

The inductive loss caused by routing of lamp lead wire, which is closed to conductive section, may require the kick-off voltage greater than specified kick-off voltage.

The liquid crystal may leak out when the LCD is broken. If the liquid crystal drip into the eyes or mouth washes it out immediately.

The caution to other ordinal electronic component should be followed also.

Don't use or store the module in corrosive gas environment.

12 Packing Form

12.1 Fig.3 shows packaging form.

12.2 Carton stock conditions

- a) Maximum number of Carton being stuck: 6
- b) Maximum number of product contained: 10 Unit
- c) Carton size: 408mm (W) x 203mm (H) x 244mm (D)
- d) Total mass (for 10Unit): Approximately 6kg
- e) Carton stock environment:
  - 1) Temperature: 0 ~ 40°C
  - 2) Humidity: Up to 60%RH
  - 3) Ambiance: No gases bite into electronic components and wiring materials
  - 4) Period: Approximately 3month
  - 5) Unpacking: To prevent LCD module from damaging by ESD, unpack the module with effective measure after controlling humidity 50%RH or more.

13 Marking of product name

SHARP		MADE IN CHINA		Model name
LQ084V3DG01		07Y00001 Q A		Country of origin
COLD CATHODE FLUORESCENT LAMP IN LCD PANEL CONTAINS A SMALL AMOUNT OF MERCURY, PLEASE FOLLOW LOCAL ORDINANCES OR REGULATIONS FOR DISPOSAL. 当該液晶ディスプレイパネルは蛍光管が組込まれていますので、地方自治体の条例、または、規則に従って廃棄して下さい。				Revision marks (A, B, C, ...)
HIGH VOLTAGE CAUTION		RISK OF ELECTRIC SHOCK DISCONNECT THE ELECTRIC POWER BEFORE SERVICING		Interoffice control code (Q, L, etc.)
				Serial No. contents
				Production year (ex. 2007 → "07")
				Production month (JAN:A, FEB:B, ..., DEC:L)
				Serial number( 00001 ~ )

14 Miscellaneous

- a) Variable resistor has been set optimally before shipment, so do not change any adjusted value. If adjusted value is changed, the specification may be not satisfied.
- b) Don't disassemble this module, it may cause malfunction.
- c) Image retention may occur when the fixed image is display for long time.
- d) Liquid crystal panel drive input FFC/FPC specification
  - The following FFC/FPC is recommended for input connector.  
[IMSA-9637S-33Y902 (IRISO Electronics co.,ltd.) , 33pin 0.5mm pitch)]
  - The terminal of FFC/FPC of input connector recommend to be gold or gold plated.  
Because point of contact of the connection is gold plated.
- e) When any question or issue occurs, it shall be solved by mutual discussion.

15 Reliability Test Items

No.	Test parameter	Conditions
1	High temperature storage test	Leaves the module at Ta=80°C for 240h
2	Low temperature storage test	Leaves the module at Ta=-30°C for 240h
3	High temperature & high humidity operation test	Operates the module at Ta=40°C;90~95%RH for 240h (No condensation)
4	High temperature operation test	Operates the module with +80°C at panel surface for 240h
5	Low temperature operation test	Operates the module at Ta=-30°C for 240h
6	Strength against ESD	±200V·200pF [0Ω] one time for each terminal
7	Shock test (non- operating)	Max. acceleration : 686m/s <sup>2</sup> (70G) Pulse width : 6ms, half sine wave Direction : ±X,±Y,±Z once for each direction.
8	Vibration test (non- operating)	Frequency : 10~57Hz/Vibration width (one side):0.15mm : 58~500Hz/ acceleration:19.6m/s <sup>2</sup> Sweep time : 11 minutes Test period : 3 hours (1 hour for each direction of X,Y,Z)
9	Thermal shock test	-30°C[0.5h] ~ +80°C[0.5h] /50 cycle

[Result Evaluation Criteria]

Under the display quality test conditions with normal operation state, these shall be no change which may affect practical display function.

[Note] The directions of X, Y, Z are defined as below:

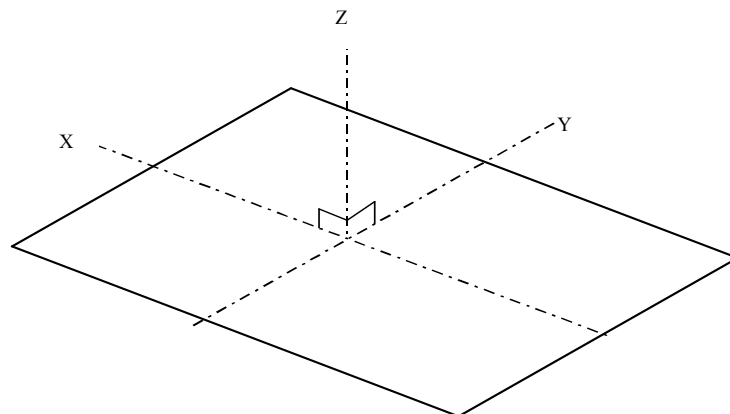

SHARP

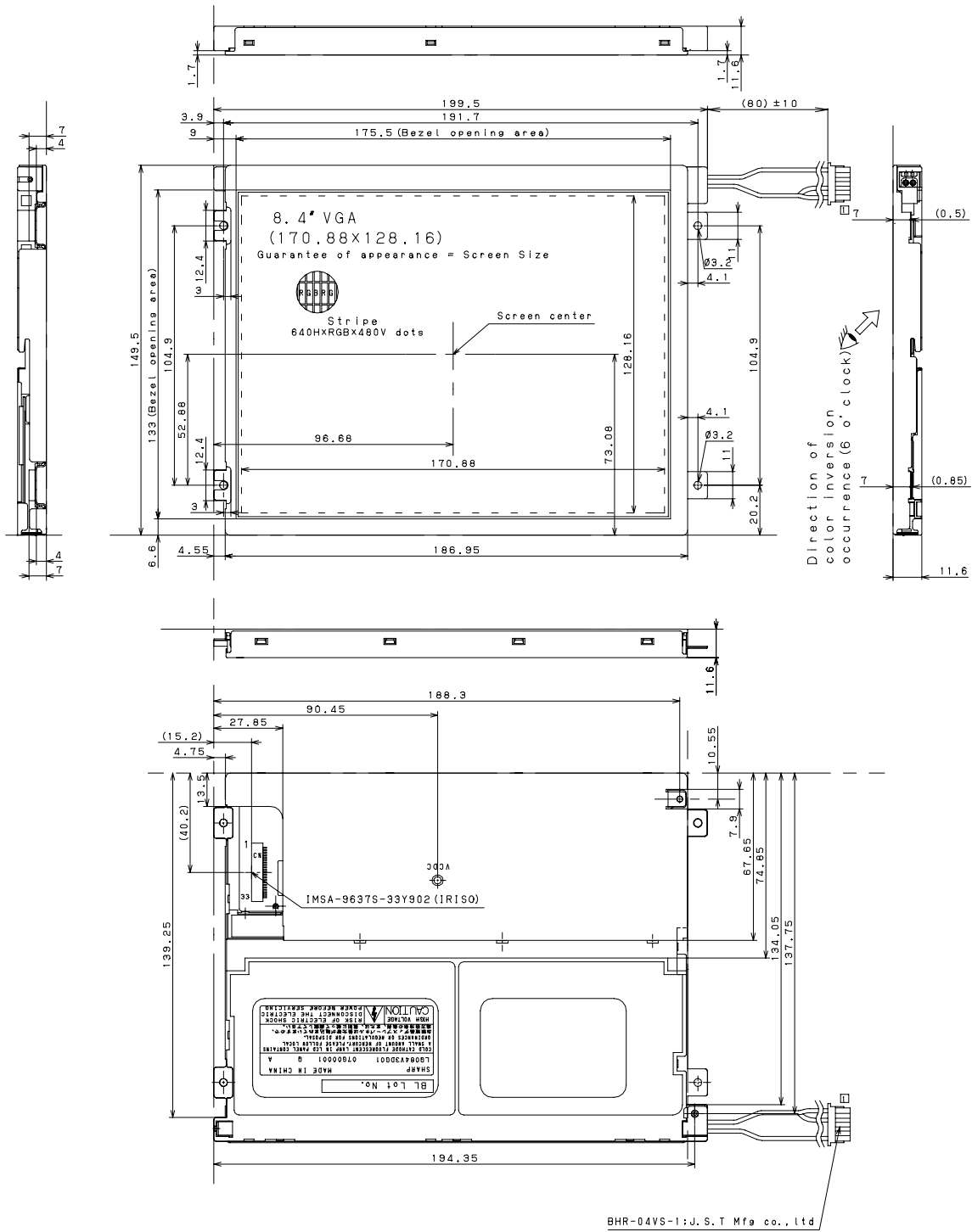

General tolerance is  $\pm 0.5$ .

Take care in set design to hide the scratches and bubbles appeared on the polarizer or other frame area which is located outside of active area.

unit:mm	Please do not copy this material and do not disclose this to third party.		▲		
DATE	2007.07.30	SCALE	▲		
MODEL	LQ01841V3DGI01111	free	▲	No.	DATE REVISION
DRAWING No	LCM11-01725A	size A2	▲	ENGINEERING DEPARTMENT MOBILE LCD DIVISION MOBILE LIQUID CRYSTAL DISPLAY GROUP SHARP CORPORATION	

FIG.1 OUTLINE DIMENSIONS

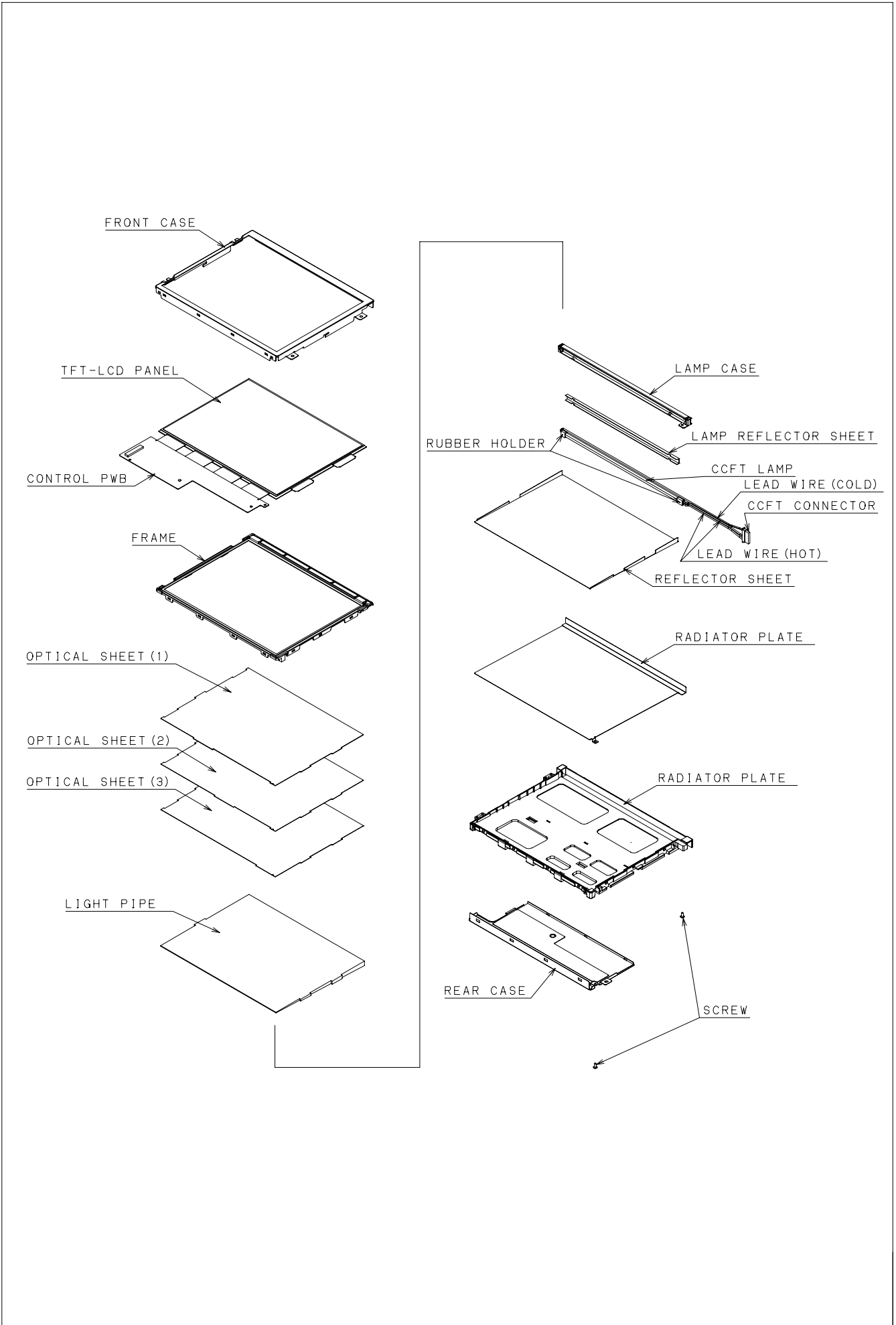

FIG.2 MODULE CONFIGURATION

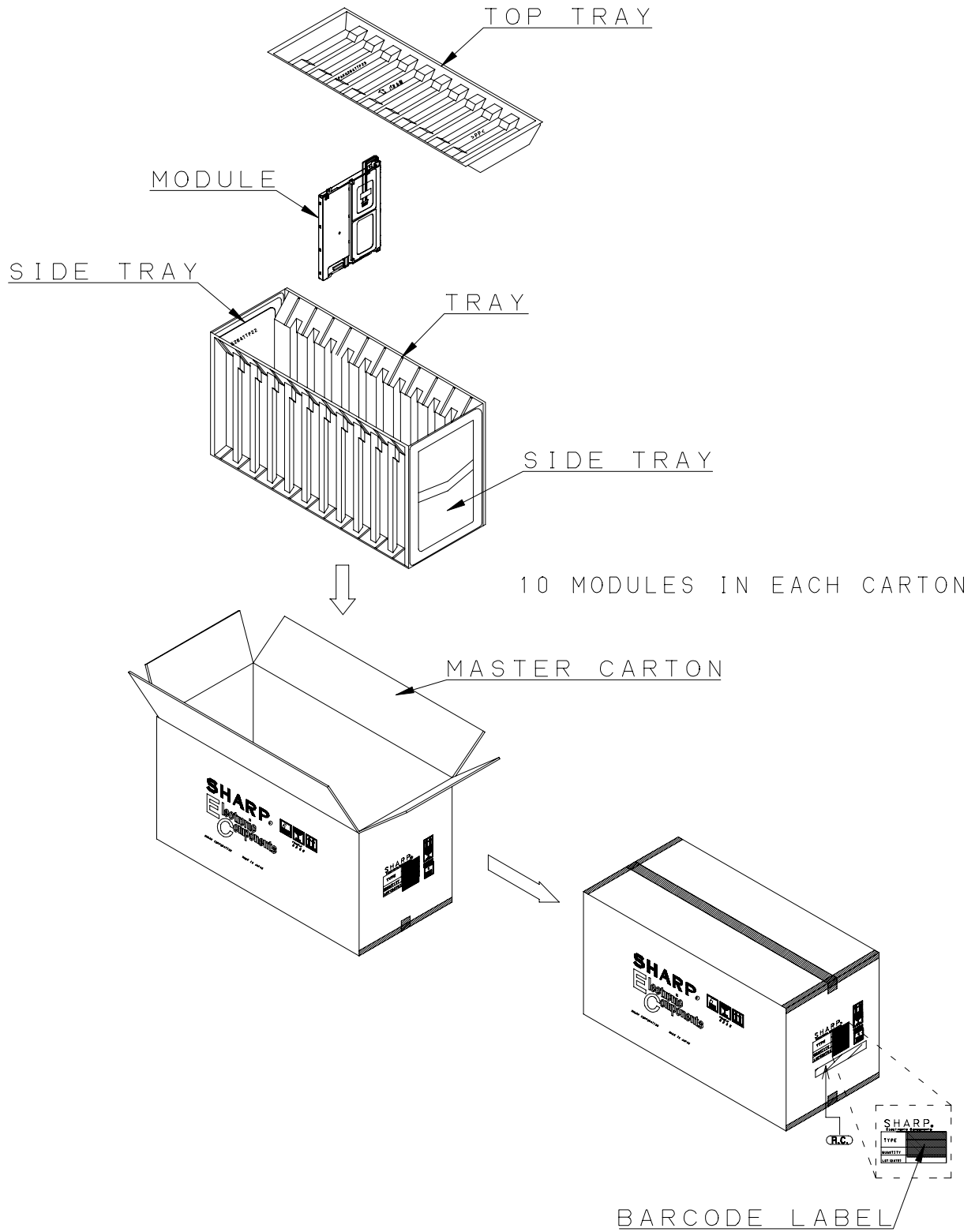

FIG.3 PACKING FORM

# LCD Specification

## LCD Group



### NORTH AMERICA

Sharp Microelectronics of the Americas  
5700 NW Pacific Rim Blvd.  
Camas, WA 98607, U.S.A.  
Phone: (1) 360-834-2500  
Fax: (1) 360-834-8903  
www.sharpsma.com

### TAIWAN

Sharp Electronic Components  
(Taiwan) Corporation  
8F-A, No. 16, Sec. 4, Nanking E. Rd.  
Taipei, Taiwan, Republic of China  
Phone: (886) 2-2577-7341  
Fax: (886) 2-2577-7326/2-2577-7328

### CHINA

Sharp Microelectronics of China  
(Shanghai) Co., Ltd.  
28 Xin Jin Qiao Road King Tower 16F  
Pudong Shanghai, 201206 P.R. China  
Phone: (86) 21-5854-7710/21-5834-6056  
Fax: (86) 21-5854-4340/21-5834-6057  
Head Office:  
No. 360, Bashen Road,  
Xin Development Bldg. 22  
Waigaoqiao Free Trade Zone Shanghai  
200131 P.R. China  
Email: smc@china.global.sharp.co.jp

### EUROPE

Sharp Microelectronics Europe  
Division of Sharp Electronics (Europe) GmbH  
Sonninstrasse 3  
20097 Hamburg, Germany  
Phone: (49) 40-2376-2286  
Fax: (49) 40-2376-2232  
www.sharpsme.com

### SINGAPORE

Sharp Electronics (Singapore) PTE., Ltd.  
438A, Alexandra Road, #05-01/02  
Alexandra Technopark,  
Singapore 119967  
Phone: (65) 271-3566  
Fax: (65) 271-3855

### KOREA

Sharp Electronic Components  
(Korea) Corporation  
RM 501 Geosung B/D, 541  
Dohwa-dong, Mapo-ku  
Seoul 121-701, Korea  
Phone: (82) 2-711-5813 ~ 8  
Fax: (82) 2-711-5819

### JAPAN

Sharp Corporation  
Electronic Components & Devices  
22-22 Nagaïke-cho, Abeno-Ku  
Osaka 545-8522, Japan  
Phone: (81) 6-6621-1221  
Fax: (81) 6117-725300/6117-725301  
www.sharp-world.com

### HONG KONG

Sharp-Roxy (Hong Kong) Ltd.  
3rd Business Division,  
17/F, Admiralty Centre, Tower 1  
18 Harcourt Road, Hong Kong  
Phone: (852) 28229311  
Fax: (852) 28660779  
www.sharp.com.hk  
Shenzhen Representative Office:  
Room 13B1, Tower C,  
Electronics Science & Technology Building  
Shen Nan Zhong Road  
Shenzhen, P.R. China  
Phone: (86) 755-3273731  
Fax: (86) 755-3273735

SPECIFICATIONS ARE SUBJECT TO CHANGE WITHOUT NOTICE.

Suggested applications (if any) are for standard use; See Important Restrictions for limitations on special applications. See Limited Warranty for SHARP's product warranty.

The Limited Warranty is in lieu, and exclusive of, all other warranties, express or implied.

ALL EXPRESS AND IMPLIED WARRANTIES, INCLUDING THE WARRANTIES OF MERCHANTABILITY, FITNESS FOR USE AND FITNESS FOR A PARTICULAR PURPOSE, ARE SPECIFICALLY EXCLUDED. In no event will SHARP be liable, or responsible in any way, for any incidental or consequential economic or property damage.