

## Power Schottky Rectifier - 20Amp 150Volt

**Features**

- Plastic package has Underwriters Laboratory Flammability Classifications 94V-0
- High Junction Temperature Capability
- Low forward voltage, high current capability
- High surge capacity
- Low power loss, high efficiency
- ESD performance human body mode > 6 KV

**Application**

- AC/DC Switching Adaptor and other Switching Power Supply

**Absolute maximum ratings**

Symbol	Ratings	Unit	Conditions
IF(AV)	20	A	Average Forward Current
VRRM	150	V	Repetitive Peak Reverse Voltage
IFSM	150	A	Peak Forward Surge Current
VF	0.63	V	Forward Voltage Drop
Tj, Tstg	-50 to +175	°C	Operating and Storage Temperature

**Electrical characteristics**

Parameters	Symbol	Ratings	Conditions
Maximum Instantaneous Forward Voltage	VF	0.79V	Per Leg at IF = 10A Tc = 25°C
		0.63V	Tc = 125°C
Maximum Reverse Leakage Current	IR	0.05mA	Per Leg at VR = 150V Tc = 25°C
		10mA	Tc = 125°C
Typical Thermal Resistance, Junction to Case	Rθ(j-c)	2.2 °C/W	Per Leg TO-220AB
		4.5 °C/W	ITO-220AB

June 2012 / Rev.6.8

# MBR20L150CT/FCT

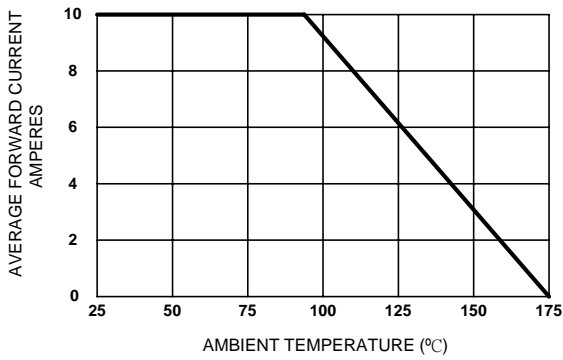

Figure 1. Forward Current Derating Curve

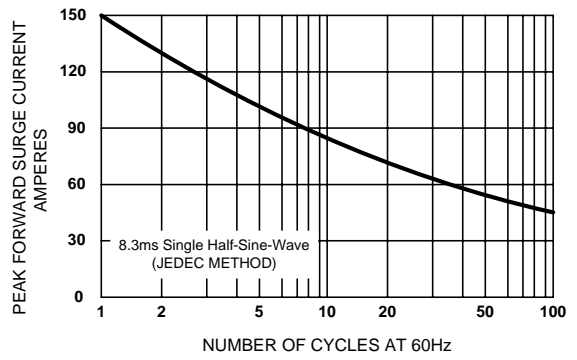

Figure 2. Maximum Non-repetitive Surge Current

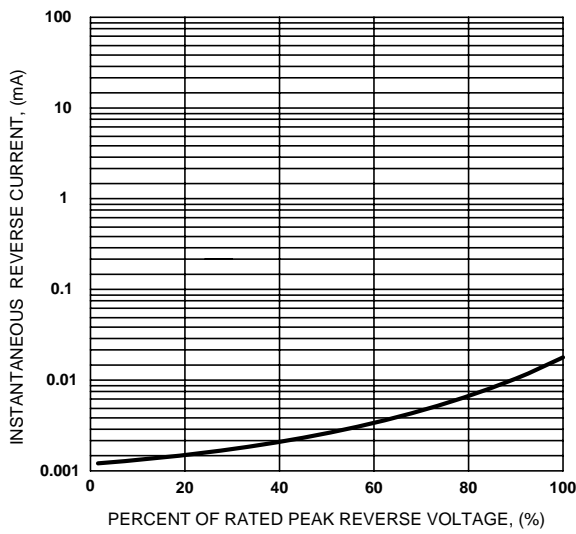

Figure 3. Typical Reverse Characteristics

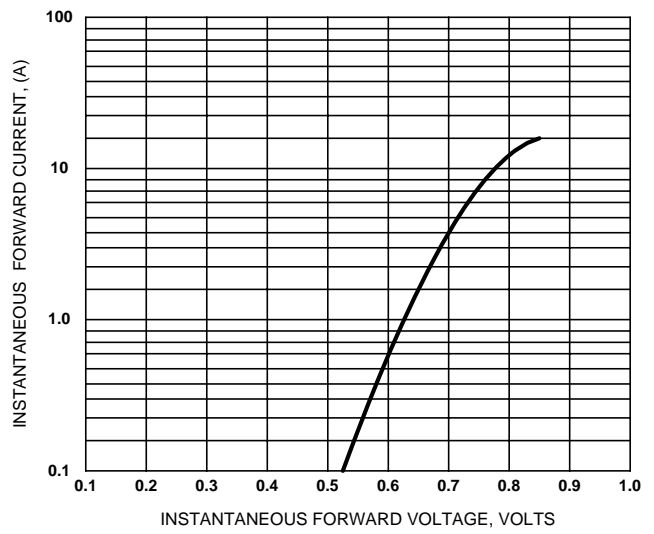

Figure 4. Typical Forward Characteristics

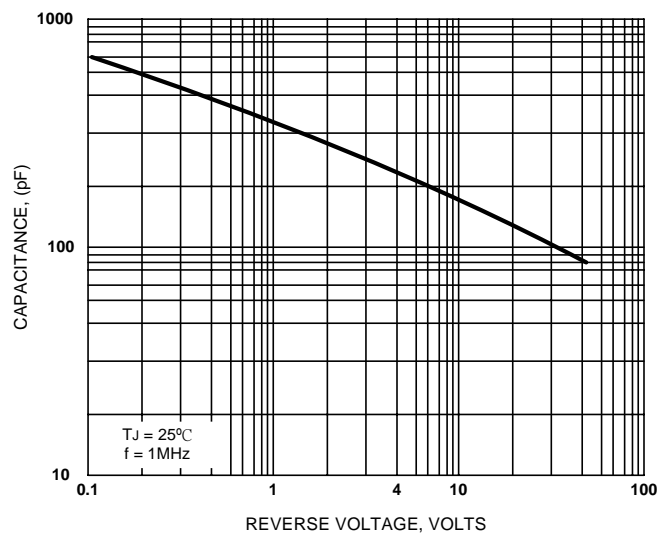

Figure 5. Typical Junction Capacitance



Sirectifier Global Corp., Delaware, U.S.A.

U.S.A.: [sgc@sirectsemi.com](mailto:sgc@sirectsemi.com) France: [ss@sirectsemi.com](mailto:ss@sirectsemi.com) Taiwan: [se@sirectsemi.com](mailto:se@sirectsemi.com) Hong Kong: [hk@sirectsemi.com](mailto:hk@sirectsemi.com)  
 China: [st@sirectsemi.com](mailto:st@sirectsemi.com) Thailand: [th@sirectsemi.com](mailto:th@sirectsemi.com) Philippines: [aiac@sirectsemi.com](mailto:aiac@sirectsemi.com) Belize: [belize@sirectsemi.com](mailto:belize@sirectsemi.com)

**MBR20L150CT**

**TO-220AB**

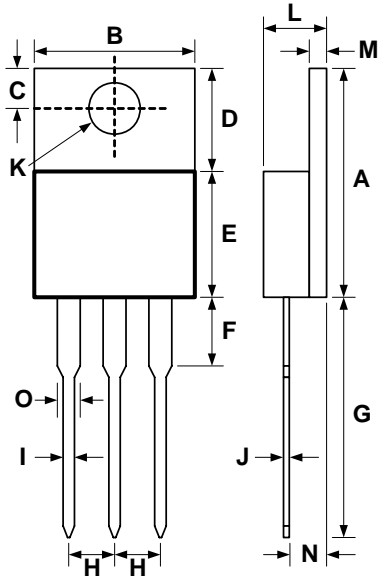

DIMENSIONS					
DIM	INCHES		MM		NOTE
	MIN	MAX	MIN	MAX	
A	.579	.606	14.70	15.40	
B	.392	.411	9.95	10.45	
C	.104	.116	2.65	2.95	
D	.248	.272	6.30	6.90	
E	.325	.350	8.25	8.90	
F	.126	.157	3.20	4.00	
G	.492	.551	12.50	14.00	
H	.096	.108	2.45	2.75	
I	.028	.039	0.70	1.00	
J	.010	.022	0.25	0.55	
K	.146	.157	3.70	4.00	
L	.167	.187	4.25	4.75	
M	.045	.057	1.15	1.45	
N	.089	.114	2.25	2.90	
O	.047	.055	1.20	1.40	

**MBR20L150FCT**

**ITO-220AB**

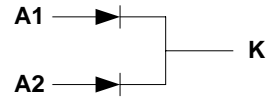
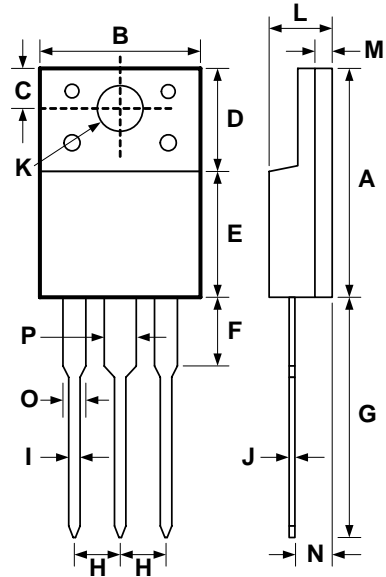

DIMENSIONS					
DIM	INCHES		MM		NOTE
	MIN	MAX	MIN	MAX	
A	.577	.600	14.65	15.25	
B	.386	.406	9.80	10.30	
C	.098	.114	2.50	2.90	
D	.258	.274	6.55	6.95	
E	.315	.331	8.00	8.40	
F	.110	.161	2.80	4.10	
G	.508	.571	12.90	14.50	
H	.089	.106	2.25	2.70	
I	.020	.033	0.50	0.85	
J	.020	.028	0.50	0.70	
K	.120	.138	3.05	3.50	
L	.169	.185	4.30	4.70	
M	.051	.063	1.30	1.60	
N	.079	.112	2.00	2.85	
O	.043	.055	1.10	1.40	
P	.051	.071	1.30	1.80	