



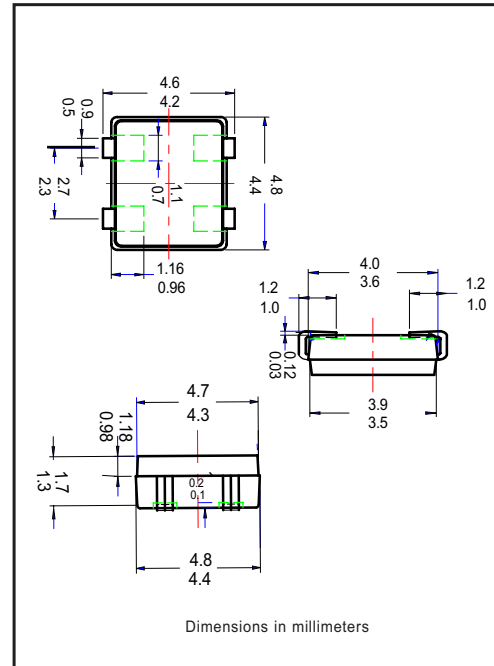
**SCHOTTKY BARRIER BRIDGE RECTIFIER**  
VOLTAGE RANGE 80 TO 200 Volts CURRENT 2.0 Ampere

**FEATURES**

- \* Low switching noise
- \* Low forward voltage drop
- \* High current capability
- \* High switching capability
- \* High surge capability
- \* High reliability

**MECHANICAL DATA**

- \* Case: Molded plastic
- \* Epoxy: Device has UL flammability classification 94V-0
- \* Lead: MIL-STD-202E method 208C guaranteed
- \* Mounting position: Any
- \* Weight: 0.134 gram



**MAXIMUM RATINGS AND ELECTRICAL CHARACTERISTICS**

Ratings at 25 °C ambient temperature unless otherwise specified.

**MAXIMUM RATINGS (@ TA=25 °C unless otherwise noted)**

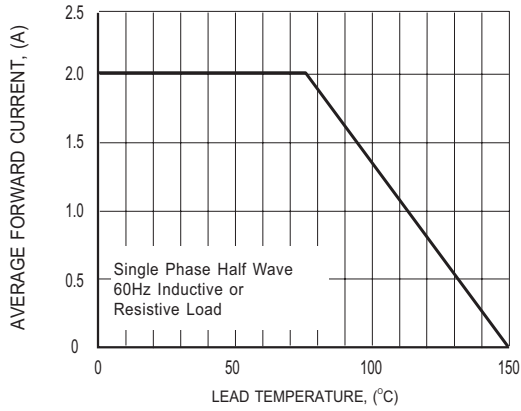
RATINGS	SYMBOL	2KMD80SJ	2KMD100SJ	2KMD150SJ	2KMD200SJ	UNITS
Maximum Recurrent Peak Reverse Voltage	$V_{RRM}$	80	100	150	200	Volts
Maximum RMS Voltage	$V_{RMS}$	56	70	105	140	Volts
Maximum DC Blocking Voltage	$V_{DC}$	80	100	150	200	Volts
Maximum Average Forward Rectified Current at Derating Lead Temperature	$I_O$	2.0				Amps
Peak Forward Surge Current 8.3 ms single half sine-wave superimposed on rated load (JEDEC method)	$I_{FSM}$	60				Amps
Typical Thermal Resistance (Note 1)	$R_{\theta JA}$	50				°C/W
	$R_{\theta JL}$	15				
Typical Junction Capacitance (Note 3)	$C_J$	110				pF
Operating Temperature Range	$T_J$	150				°C
Storage Temperature Range	$T_{STG}$	-55 to + 150				°C

**ELECTRICAL CHARACTERISTICS (@TA=25 °C unless otherwise noted)**

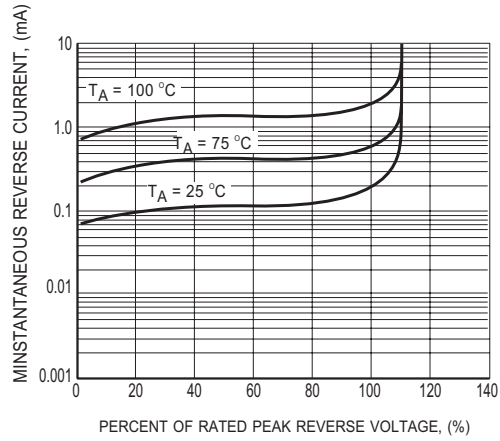
CHARACTERISTICS	SYMBOL	2KMD80SJ THRU 2KMD200SJ			UNITS
Maximum Instantaneous Forward Voltage at 2.0 A DC	$V_F$	0.85			Volts
Maximum Average Reverse Current at Rated DC Blocking Voltage	$I_R$	@ $T_A = 25^\circ\text{C}$	200		uA
		@ $T_A = 100^\circ\text{C}$	2		mA

- NOTES : 1. Thermal Resistance : At 9.5mm lead lengths, PCB mounted.  
2. Measured at 1 MHz and applied reverse voltage of 4.0 volts.  
3. "Fully ROHS compliant", "100% Sn plating (Pb-free)".

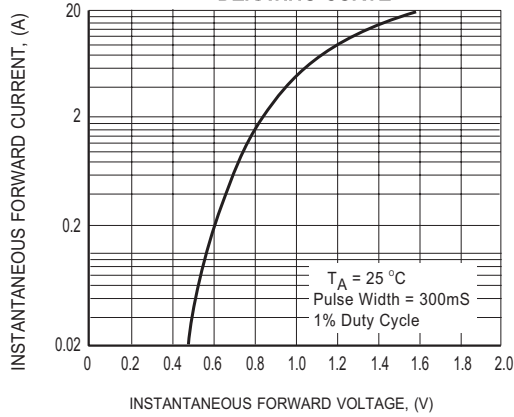
## RATING AND CHARACTERISTICS CURVES ( 2KMD80SJ THRU 2KMD200SJ )



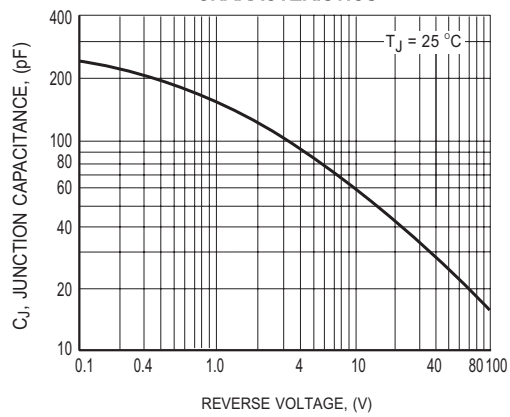
**FIG.1 TYPICAL FORWARD CURRENT DERATING CURVE**



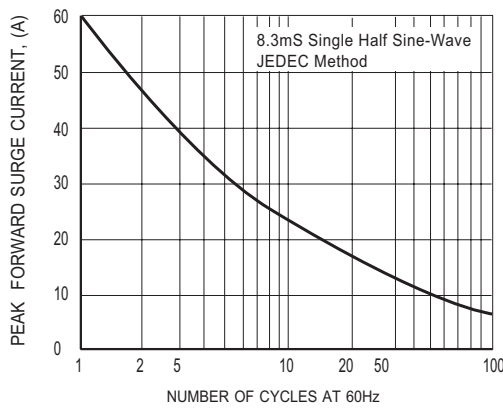
**FIG.2 TYPICAL REVERSE CHARACTERISTICS**



**FIG.3 TYPICAL INSTANTANEOUS FORWARD CHARACTERISTICS**

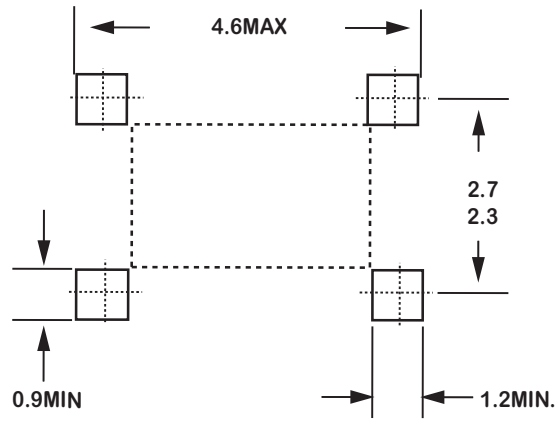


**FIG.4 TYPICAL JUNCTION CAPACITANCE**



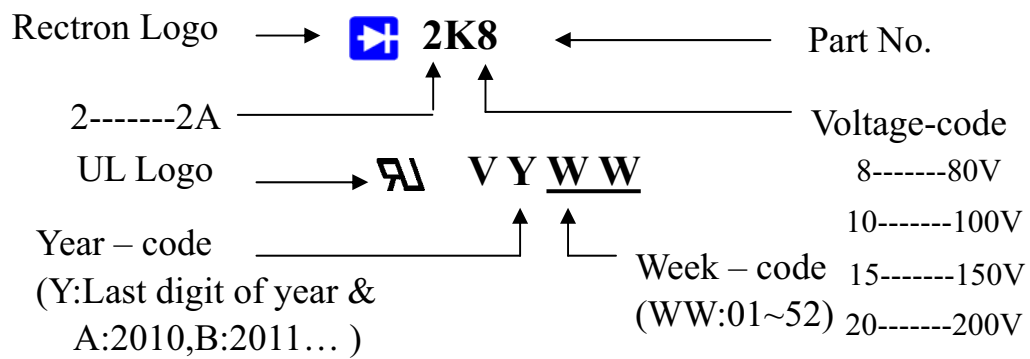
**FIG.5 MAXIMUM NON-REPETITIVE FORWARD SURGE CURRENT**

## Mounting Pad Layout



Dimensions in millimeters

## Marking Description



## PACKAGING OF DIODE AND BRIDGE RECTIFIERS

### REEL PACK

PACKAGE	PACKING CODE	EA PER REEL	COMPONENT SPACE(mm)	TAPE SPACE (mm)	REEL DIA (mm)	CARTON SIZE (mm)	EA PER CARTON	GROSS WEIGHT(Kg)
MDSJ	-T	500	---	---	178	390*205*310	16,000	---
MDSJ	-W	3,000	---	---	330	355*360*350	48,000	15.50

## DISCLAIMER NOTICE

Rectron Inc reserves the right to make changes without notice to any product specification herein, to make corrections, modifications, enhancements or other changes. Rectron Inc or anyone on its behalf assumes no responsibility or liability for any errors or inaccuracies. Data sheet specifications and its information contained are intended to provide a product description only. "Typical" parameters which may be included on RECTRON data sheets and/ or specifications can and do vary in different applications and actual performance may vary over time. Rectron Inc does not assume any liability arising out of the application or use of any product or circuit.

Rectron products are not designed, intended or authorized for use in medical, life-saving implant or other applications intended for life-sustaining or other related applications where a failure or malfunction of component or circuitry may directly or indirectly cause injury or threaten a life without expressed written approval of Rectron Inc. Customers using or selling Rectron components for use in such applications do so at their own risk and shall agree to fully indemnify Rectron Inc and its subsidiaries harmless against all claims, damages and expenditures.