



### Features

- ◇ For IF SAW filter
- ◇ High attenuation
- ◇ Single-ended operation
- ◇ Dual In-line Package
- ◇ RoHS compliant (2002/95/EC), Pb-free

### Specifications

Parameter	Unit	Minimum	Typical	Maximum
Center Frequency	MHz	204.4	204.5	204.6
Insertion Loss	dB	-	21.6	26
1 dB Bandwidth	MHz	-	3.61	-
3 dB Bandwidth	MHz	3.8	3.88	-
40 dB Bandwidth	MHz	-	4.97	5.02
Passband Variation	dB	-	0.6	1
Group Delay Variation( $f_0 \pm 1.5\text{MHz}$ )	nsec	-	120	200
Absolute Delay	usec	-	2.47	-
Ultimate Rejection	dB	45	48	-
Material Temperature coefficient	KHz/°C	0.2		
Substrate Material	-	Qz		
Ambient Temperature	°C	25		
Operating Temperature Range	°C	-40	-	+85
Storage Temperature Range	°C	-45	-	+105
DC Voltage	V	0		
Input Power	dBm	-	-	10
ESD Class	-	1B		
Package Size	DIP2712 (27.0x12.8x4.7mm3)			

#### Notes:

1. All specifications are based on the test circuit shown;
2. In production, all specifications are measured by Agilent Network analyzer and full 2 port calibration at room temperature;
3. Electrical margin has been built into the design to account for the variations due to temperature drift and manufacturing tolerances;
4. This is the optimum impedance in order to achieve the performance show.

	<b>SIPAT Co., Ltd.</b> ( CETC No.26 Research Institute ) #14 Nanping Huayuan Road, Chongqing, China, 400060	Part Number	LBS20501	
		Rev. Date	2009-04-24	
		Ver.	1.0	Page 1/3

### Matching Configuration

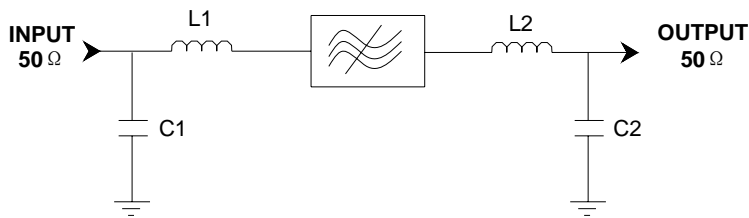

**L1=33nH L2=27nH**  
**C1=39pF C2=27pF**  
**Source/Load Impedance=50 ohm**

Notes - Component values may change depending  
on board layout.

### Package Dimension

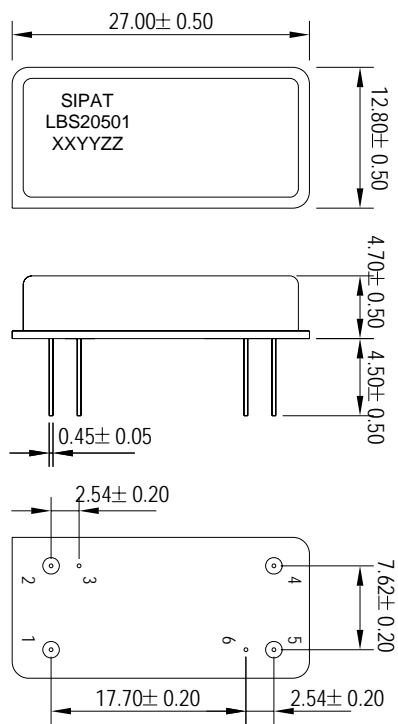

#### Pad Configuration:

Input 1  
Output 5  
Ground All Others

#### Marking Configuration:

- 1) SIPAT: Manufacturer Name
- 2) LBS20501: Part Number
- 3) XXYY: Date(Year/month)
- 4) ZZ: Identified Code

Package: DIP2712

Unit: mm



**SIPAT Co., Ltd.**  
( CETC No.26 Research Institute )  
#14 Nanping Huayuan Road,  
Chongqing, China, 400060

Part Number	LBS20501	
Rev. Date	2009-04-24	
Ver.	1.0	Page 2/3

*Typical Performance*

Frequency Respond

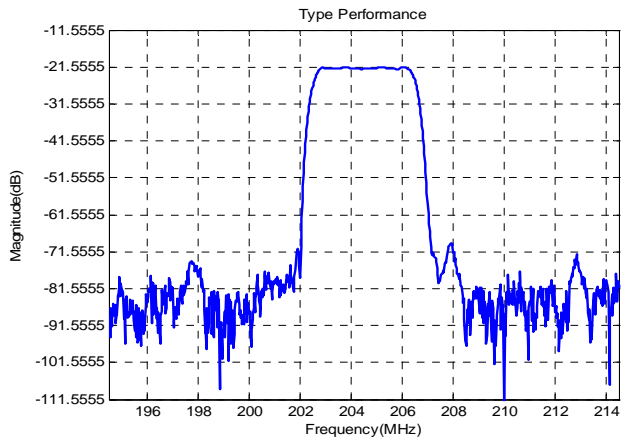

Horizontal: 2MHz/Div

Vertical: 10dB/Div

Passband Respond

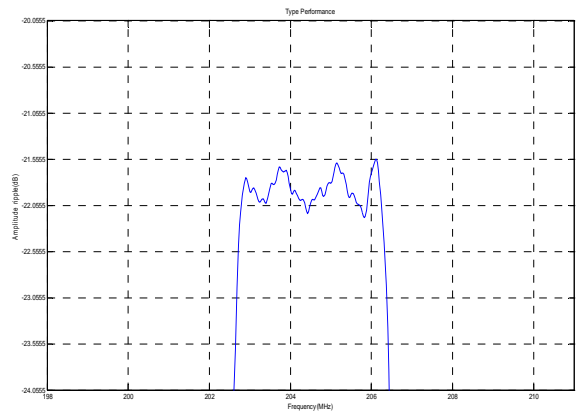

Horizontal: 2MHz/Div

Vertical: 0.5dB/Div

Group Delay Variation( $f_0 \pm 1.5\text{MHz}$ )

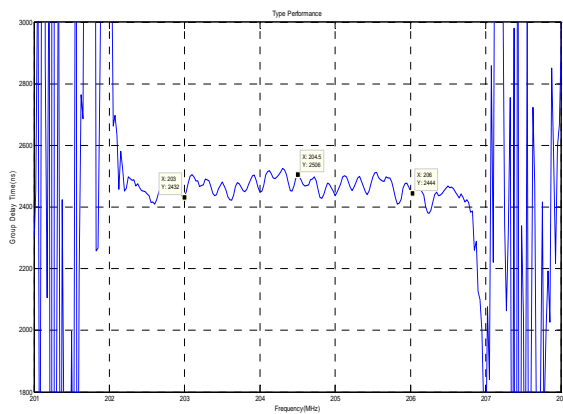

Horizontal: 1MHz/Div

Vertical: 200ns/Div

Phase Linearity( $f_0 \pm 1.5\text{MHz}$ )

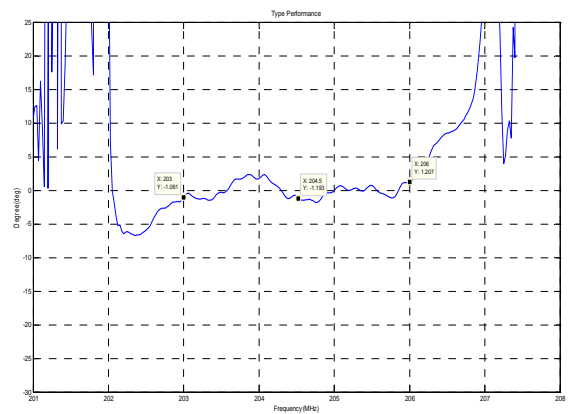

Horizontal: 1MHz/Div

Vertical: 5deg/Div

Smith Chart S11

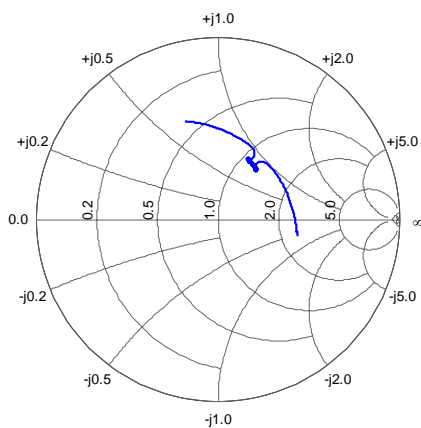

Smith Chart S22

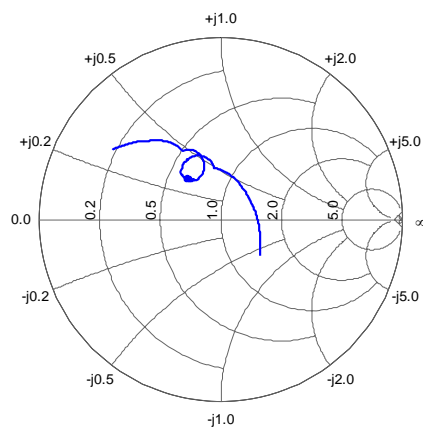

**SIPAT Co., Ltd.**  
( CETC No.26 Research Institute )  
#14 Nanping Huayuan Road,  
Chongqing, China, 400060

Part Number

LBS20501

Rev. Date

2009-04-24

Ver.

1.0

Page 3/3