

TOSHIBA Photocoupler GaAs Ired & Photo-Transistor

TLP624, TLP624-2, TLP624-4

Programmable Controllers
AC/DC-Input Module
Telecommunication

The TOSHIBA TLP624, -2 and -4 consist of a gallium arsenide infrared emitting diode optically coupled to a photo-transistor.
The TLP624-2 offers two isolated channels in an eight lead plastic DIP, while the TLP624-4 provides four isolated channels in a sixteen lead plastic DIP.

- Collector-emitter voltage: 55V min.
- Current transfer ratio

Classification	Current Transfer Ratio(min)			Marking of classification
	Ta = 25°C		Ta = -25~75°C	
Rank BV	If=1mA VCE=0.5V	If=0.5mA VCE=1.5V	If=1mA VCE=0.5V	BV
Standard	200%	100%	100%	BV,blank

- Isolation voltage: 5000V_{rms} min.
- UL recognized: UL1577, file No.E67349
- BSI approved: BS EN60065: 1994 Certificate No.7426
BS EN60950: 1992 Certificate No.7427
- Note: Application type name for certification test, please use standard product type name, i.e.
TLP624(BV): TLP624
TLP624-2(BV): TLP624-2

Pin Configurations(top view)

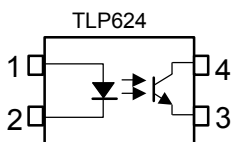

- 1. Anode
- 2. Cathode
- 3. Emitter
- 4. Collector

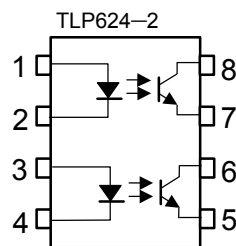

- 1,3 : Anode
- 2,4 : Cathode
- 5,7 : Emitter
- 6,8 : Collector

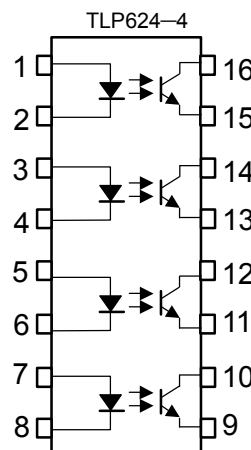

- 1,3,5,7: Anode
- 2,4,6,8: Cathode
- 9,11,13,15: Emitter
- 10,12,14,16: Collector

Unit in mm

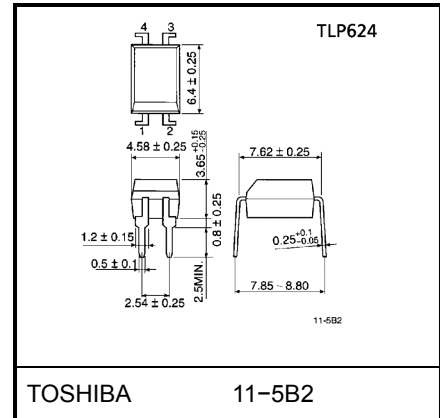

Weight: 0.26 g

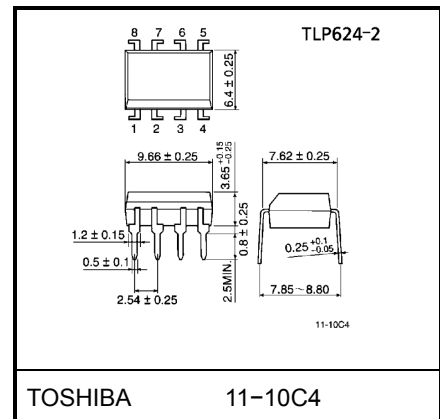

Weight: 0.54 g

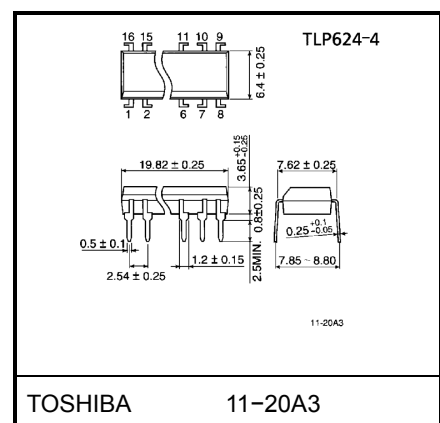

Weight: 1.1 g

Maximum Ratings (Ta = 25°C)

Characteristic		Symbol	Rating		Unit
			TLP624	TLP624-2 TLP624-4	
LED	Forward current	I_F	60	50	mA
	Forward current derating	$\Delta I_F / ^\circ\text{C}$	-0.7(Ta \geq 39°C)	-0.5(Ta \geq 25°C)	mA / °C
	Pulse forward current	I_{FP}	1(100 μ s, pulse, 100pps)		A
	Power dissipation(1 Circuit)	P_D	100	70	mW
	Power dissipation derating (Ta \geq 25°C, 1 Circuit)	$\Delta P_D / ^\circ\text{C}$	-1.0	-0.7	mW / °C
	Reverse voltage	V_R	5		V
	Junction temperature	T_j	125		°C
Detector	Collector-emitter voltage	V_{CEO}	55		V
	Emitter-collector voltage	V_{ECO}	7		V
	Collector current	I_C	50		mA
	Collector power dissipation(1 circuit)	P_C	150	100	mW
	Collector power dissipation derating (Ta \geq 25°C, 1 Circuit)	$\Delta P_C / ^\circ\text{C}$	-1.5	-1.0	mW / °C
	Junction temperature	T_j	125		°C
Storage temperature range		T_{stg}	-55~125		°C
Operating temperature range		P_{opr}	-55~100		°C
Lead soldering temperature		T_{sol}	260(10s)		°C
Total package power dissipation(1 Circuit)		P_T	250	150	mW
Total package power dissipation derating (Ta \geq 25°C, 1 Circuit)		$\Delta P_T / ^\circ\text{C}$	-2.5	-1.5	mW / °C
Isolation voltage (Note 1)		BV_S	5000(AC, 1min., RH \leq 60%)		Vrms

(Note 1) Device considered a two terminal device: LED side pins shorted together, and detector side pins shorted together.

Recommended Operating Conditions

Characteristic	Symbol	Min.	Typ.	Max.	Unit
Supply voltage	V_{CC}	—	5	24	V
Forward current	I_F	—	1.6	20	mA
Collector current	I_C	—	1	10	mA
Operating temperature	T_{opr}	-25	—	75	°C

Individual Electrical Characteristics (Ta = 25°C)

Characteristic		Symbol	Test Condition	Min.	Typ.	Max.	Unit
LED	Forward voltage	V_F	$I_F = 10\text{mA}$	1.0	1.15	1.3	V
	Reverse current	I_R	$V_R = 5\text{V}$	—	—	10	μA
	Capacitance	C_T	$V = 0, f = 1\text{MHz}$	—	30	—	pF
Detector	Collector-emitter breakdown voltage	$V_{(BR)CEO}$	$I_C = 0.5\text{mA}$	55	—	—	V
	Emitter-collector breakdown voltage	$V_{(BR)ECO}$	$I_E = 0.1\text{mA}$	7	—	—	V
	Collector dark current	I_{CEO}	$V_{CE} = 24\text{V}$	—	10	100	nA
			$V_{CE} = 24\text{V}, T_a = 85^\circ\text{C}$	—	2	50	μA
Capacitance collector to emitter	C_{CE}	$V=0, f=1\text{MHz}$	—	12	—	pF	

Coupled Electrical Characteristics (Ta = 25°C)

Characteristic	Symbol	Test Condition	Min.	Typ.	Max.	Unit
Current transfer ratio	I_C / I_F	$I_F = 1\text{mA}, V_{CE} = 0.5\text{V}$ Rank BV	100	—	1200	%
			200	—	1200	
Low input CTR	I_C / I_F (low)	$I_F = 0.5\text{mA}, V_{CE} = 1.5\text{V}$ Rank BV	50	—	—	%
			100	—	—	
Collector-emitter saturation voltage	V_{CE} (sat)	$I_C = 0.5\text{mA}, I_F = 1\text{mA}$ $I_C = 1\text{mA}, I_F = 1\text{mA}$ Rank BV	—	—	0.4	V
			—	0.2	—	
			—	—	0.4	

Coupled Electrical Characteristics (Ta = -25°C~75°C)

Characteristic	Symbol	Test Condition	Min.	Typ.	Max.	Unit
Current transfer ratio	I_C / I_F	$I_F = 1\text{mA}, V_{CE} = 0.5\text{V}$ Rank BV	50	—	—	%
			100	—	—	
Low input CTR	I_C / I_F (low)	$I_F = 0.5\text{mA}, V_{CE} = 1.5\text{V}$ Rank BV	—	50	—	%
			—	100	—	

Isolation Characteristics (Ta = 25°C)

Characteristic	Symbol	Test Condition	Min.	Typ.	Max.	Unit
Capacitance input to output	C _S	V _S = 0, f = 1MHz	—	0.8	—	pF
Isolation resistance	R _S	V _S = 500V	5×10 ¹⁰	10 ¹⁴	—	Ω
Isolation voltage	BV _S	AC, 1minute	5000	—	—	V _{rms}
		AC, 1second, in oil	—	10000	—	
		DC, 1 minute, in oil	—	10000	—	V _{dc}

Switching Characteristics (Ta = 25°C)

Characteristic	Symbol	Test Condition	Min.	Typ.	Max.	Unit
Rise time	t _r	V _{CC} = 10V, I _C = 2mA R _L = 100Ω	—	8	—	μs
Fall time	t _f		—	8	—	
Turn-on time	t _{on}		—	10	—	
Turn-off time	t _{off}		—	8	—	
Turn-on time	t _{ON}	R _L = 4.7 kΩ (Fig.1) V _{CC} = 5 V, I _F = 1.6mA	—	10	—	μs
Storage time	t _S		—	50	—	
Turn-off time	T _{OFF}		—	300	—	

Fig. 1 Switching time test circuit

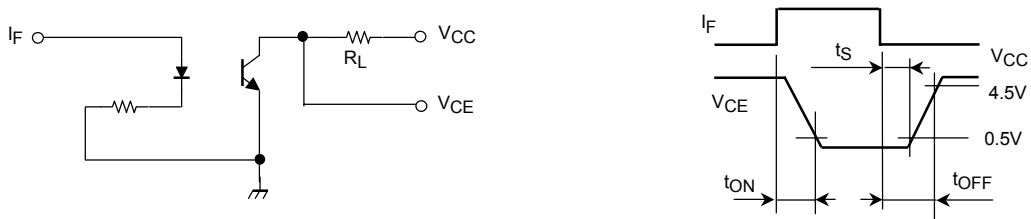

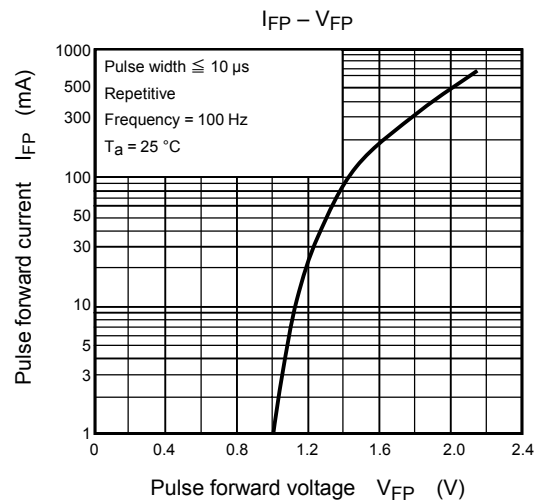
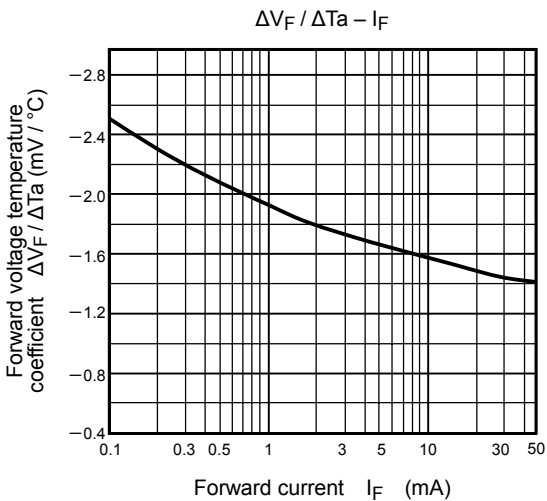
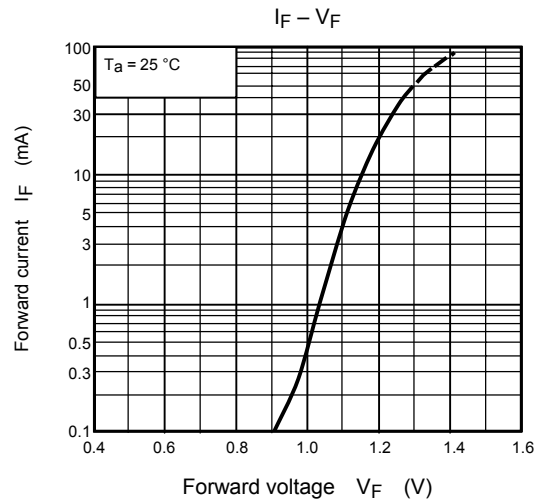
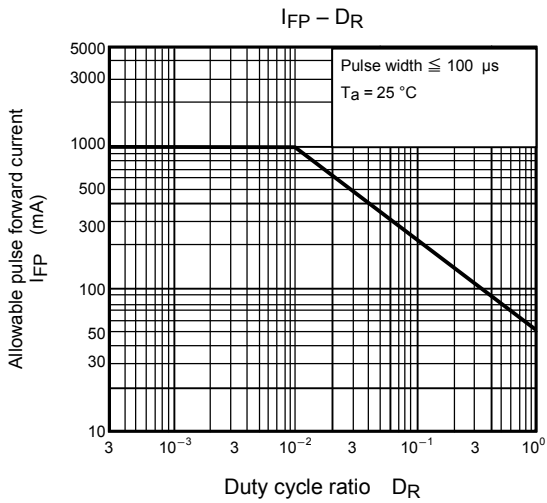
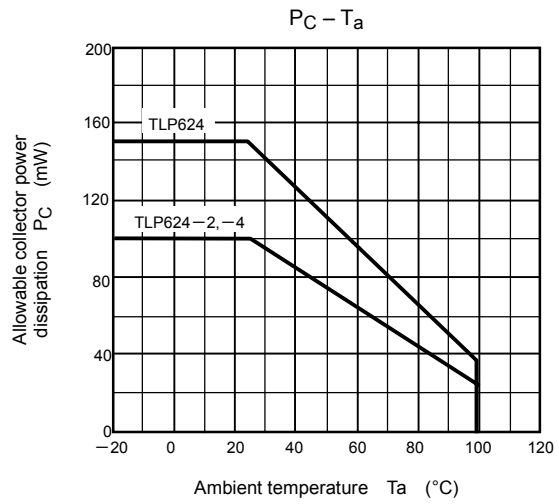
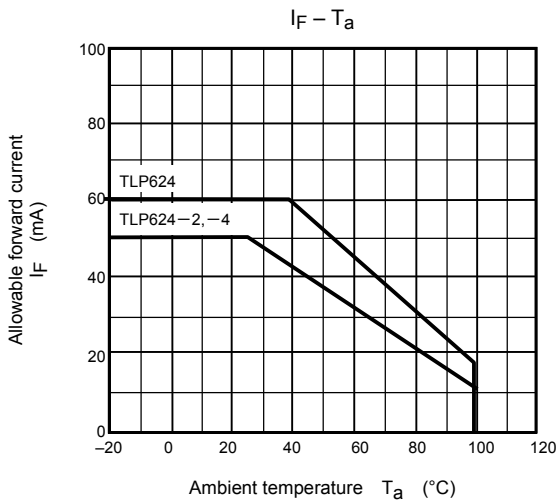

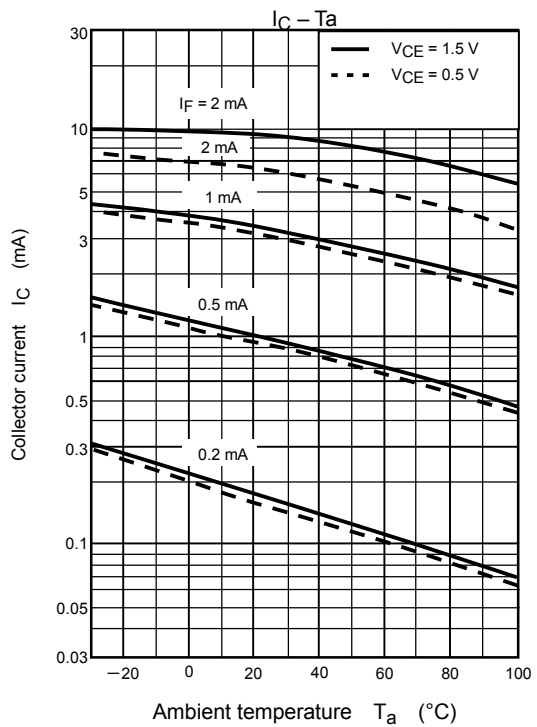
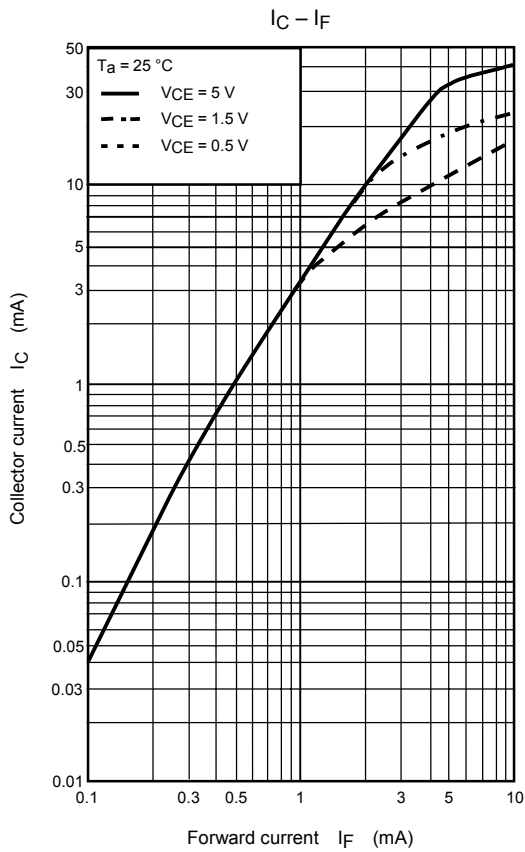
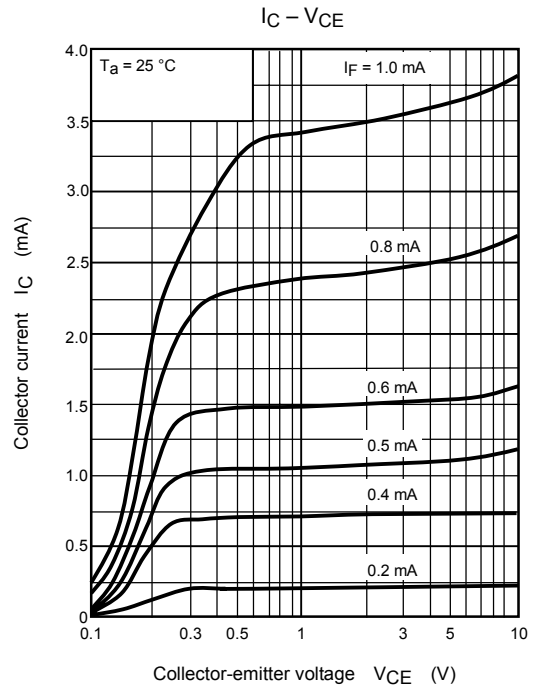
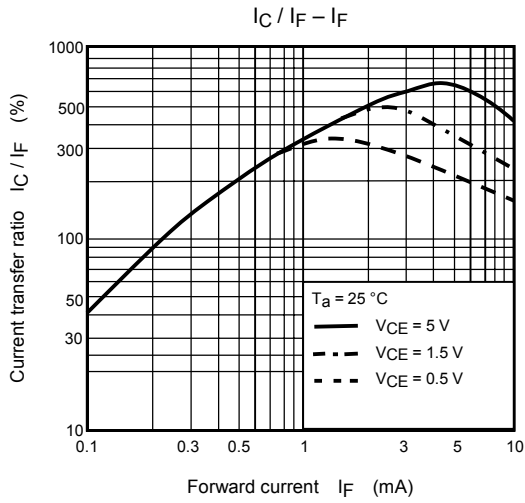

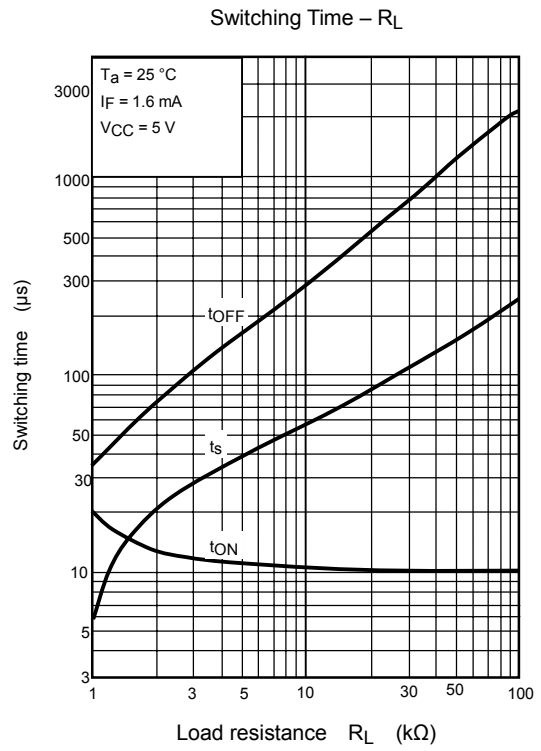
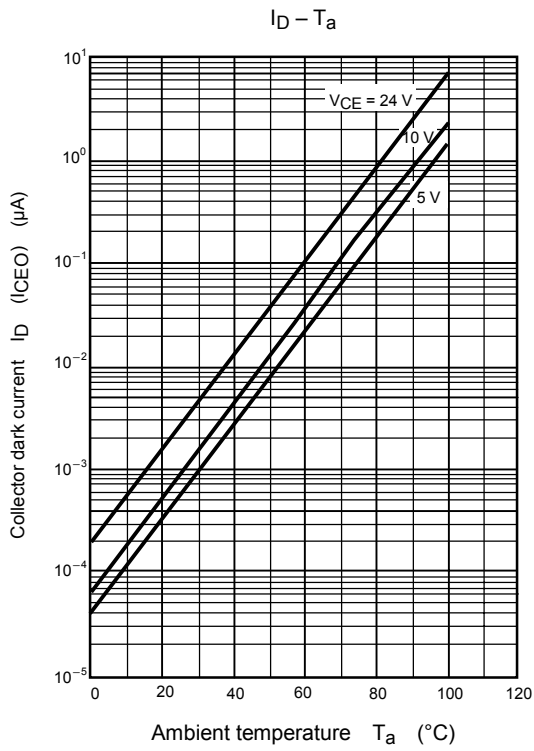

RESTRICTIONS ON PRODUCT USE

000707EBC

- TOSHIBA is continually working to improve the quality and reliability of its products. Nevertheless, semiconductor devices in general can malfunction or fail due to their inherent electrical sensitivity and vulnerability to physical stress. It is the responsibility of the buyer, when utilizing TOSHIBA products, to comply with the standards of safety in making a safe design for the entire system, and to avoid situations in which a malfunction or failure of such TOSHIBA products could cause loss of human life, bodily injury or damage to property.
In developing your designs, please ensure that TOSHIBA products are used within specified operating ranges as set forth in the most recent TOSHIBA products specifications. Also, please keep in mind the precautions and conditions set forth in the "Handling Guide for Semiconductor Devices," or "TOSHIBA Semiconductor Reliability Handbook" etc..
- The TOSHIBA products listed in this document are intended for usage in general electronics applications (computer, personal equipment, office equipment, measuring equipment, industrial robotics, domestic appliances, etc.). These TOSHIBA products are neither intended nor warranted for usage in equipment that requires extraordinarily high quality and/or reliability or a malfunction or failure of which may cause loss of human life or bodily injury ("Unintended Usage"). Unintended Usage include atomic energy control instruments, airplane or spaceship instruments, transportation instruments, traffic signal instruments, combustion control instruments, medical instruments, all types of safety devices, etc.. Unintended Usage of TOSHIBA products listed in this document shall be made at the customer's own risk.
- Gallium arsenide (GaAs) is a substance used in the products described in this document. GaAs dust and fumes are toxic. Do not break, cut or pulverize the product, or use chemicals to dissolve them. When disposing of the products, follow the appropriate regulations. Do not dispose of the products with other industrial waste or with domestic garbage.
- The products described in this document are subject to the foreign exchange and foreign trade laws.
- The information contained herein is presented only as a guide for the applications of our products. No responsibility is assumed by TOSHIBA CORPORATION for any infringements of intellectual property or other rights of the third parties which may result from its use. No license is granted by implication or otherwise under any intellectual property or other rights of TOSHIBA CORPORATION or others.
- The information contained herein is subject to change without notice.