

PLEASE CHECK WWW.MOLEX.COM FOR LATEST PART INFORMATION

Part Number: [0442480037](#)
Status: **Active**
Overview: [modular_plugs_jacks](#)
Description: Modular Jack, Right Angle, Low Profile, Inverted, Lightpipes, 6/6, 2 Ports

Documents:

[3D Model](#) [Product Specification PS-43860-003 \(PDF\)](#)
[Drawing \(PDF\)](#) [RoHS Certificate of Compliance \(PDF\)](#)

Agency Certification

CSA LR19980
 UL E107635

General

Product Family Modular Jacks/Plugs
 Series [44248](#)
 Comments Industry Compatible
 Component Type PCB Jack
 Magnetic No
 Overview [modular_plugs_jacks](#)
 Performance Category 3
 Power over Ethernet (PoE) N/A
 Product Name RJ11

Physical

Boot Color N/A
 Color - Resin Black, Clear
 Durability (mating cycles max) 500
 Flammability 94V-0
 Inverted / Top Latch Yes
 Lightpipes/LEDs Lightpipes
 Material - Metal Phosphor Bronze
 Material - Plating Mating Gold
 Material - Plating Termination Tin
 Material - Resin Polycarbonate, Polyester
 Orientation Right Angle (Side Entry)
 PCB Locator Yes
 PCB Retention Yes
 PCB Thickness Recommended (in) 0.062 In
 PCB Thickness Recommended (mm) 1.57 mm
 Packaging Type Tray
 Pitch - Mating Interface (in) 0.040 In
 Pitch - Mating Interface (mm) 1.02 mm
 Pitch - Term. Interface (in) 0.040 In
 Pitch - Term. Interface (mm) 1.02 mm
 Plating min: Mating (µin) 50
 Plating min: Mating (µm) 1.25
 Plating min: Termination (µin) 100
 Plating min: Termination (µm) 2.5
 Ports 2
 Positions / Loaded Contacts 6/6
 Surface Mount Compatible (SMC) No
 Temperature Range - Operating -40°C to +85°C
 Termination Interface: Style Through Hole
 Waterproof / Dustproof No
 Wire/Cable Type N/A

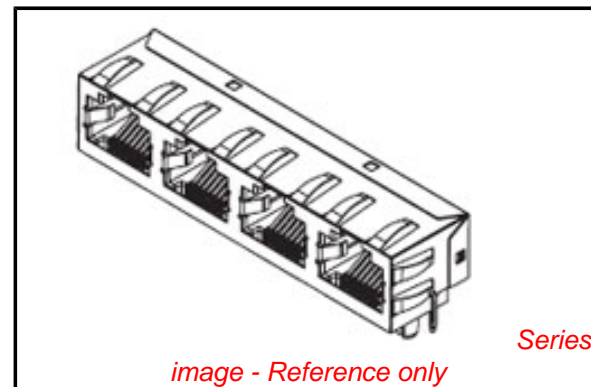

image - Reference only

EU RoHS

**ELV and RoHS
 Compliant**
REACH SVHC
 Not Reviewed
**Halogen-Free
 Status**
Not Reviewed

China RoHS



**Need more information on product
 environmental compliance?**

Email productcompliance@molex.com
 For a multiple part number RoHS Certificate of
 Compliance, [click here](#)

Please visit the [Contact Us](#) section for any
 non-product compliance questions.

Search Parts in this Series

[44248Series](#)

Mates With

FCC 68 Plugs

Electrical

Current - Maximum per Contact	1.5A
Grounding to PCB	Yes
Shielded	Yes
Voltage - Maximum	150V AC (RMS)

Solder Process Data

Duration at Max. Process Temperature (seconds)	5
Lead-free Process Capability	Wave Capable (TH only)
Max. Cycles at Max. Process Temperature	1
Process Temperature max. C	260

Material Info**Reference - Drawing Numbers**

Application Specification	AS-43860-001
Packaging Specification	PK-44248-004
Product Specification	PS-43860-003, RPS-43860-004, RPS-43860-007, RPS-43860-008, RPS-43860-013
Sales Drawing	SD-44248-001

This document was generated on 06/08/2010

PLEASE CHECK WWW.MOLEX.COM FOR LATEST PART INFORMATION

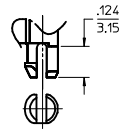

(SNAP-FIT PEG OPTION)

SCALE: NTS
SEE NOTE #8

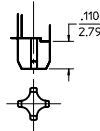

(PRESS-FIT PEG OPTION)

SCALE: NTS
SEE NOTE #8

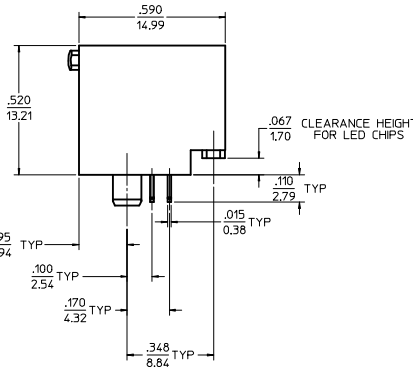
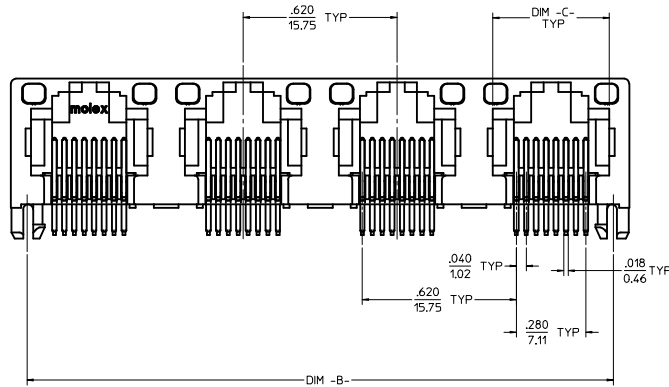
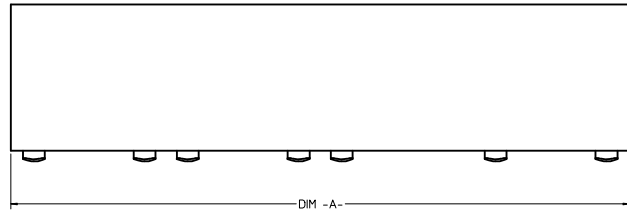

8 CIRCUIT HOUSING(S)

ASSEMBLY MATERIAL NUMBER	NUMBER OF CIRCUITS	NUMBER OF PORTS	PEG STYLE	DIM -A-	DIM -B-	DIM -C-
44248-0001	8	2	SNAP-FIT	1.250/31.75	1.120/28.45	.469/11.92
44248-0002	8	4	SNAP-FIT	2.490/63.25	2.360/59.94	.469/11.92
44248-0005	8	2	PRESS-FIT	1.250/31.75	1.120/28.45	.469/11.92
44248-0006	8	4	PRESS-FIT	2.490/63.25	2.360/59.94	.469/11.92

6 CIRCUIT HOUSING(S)

ASSEMBLY MATERIAL NUMBER	NUMBER OF CIRCUITS	NUMBER OF PORTS	PEG STYLE	DIM -A-	DIM -B-	DIM -C-
44248-0009	6	2	SNAP-FIT	1.250/31.75	1.120/28.45	.389/9.88
44248-0010	4	2	SNAP-FIT	1.250/31.75	1.120/28.45	.389/9.88
44248-0011	6	4	SNAP-FIT	2.490/63.25	2.360/59.94	.389/9.88
44248-0012	4	4	SNAP-FIT	2.490/63.25	2.360/59.94	.389/9.88
44248-0017	6	2	PRESS-FIT	1.250/31.75	1.120/28.45	.389/9.88
44248-0018	4	2	PRESS-FIT	1.250/31.75	1.120/28.45	.389/9.88
44248-0019	6	4	PRESS-FIT	2.490/63.25	2.360/59.94	.389/9.88
44248-0020	4	4	PRESS-FIT	2.490/63.25	2.360/59.94	.389/9.88

- NOTES:**
- MATERIAL:**
HOUSING: POLYESTER(PBT), GLASS FILLED, UL94V-0, COLOR: BLACK
LIGHT PIPES: POLYCARBONATE, UL-94V2, COLOR: CLEAR
TERMINALS: PHOSPHOR BRONZE
 - FINISH:**
TERMINALS:
*SELECT GOLD IN CONTACT AREA: 50 MICRONCHES (127 MICROMETERS) MIN.
*SELECT TIN IN PC TAIL AREA: 100 MICRONCHES (2.54 MICROMETERS) MIN.
WITH OVERALL NICKEL UNDERPLATE: 50 MICRONCHES (1.27 MICROMETERS) MIN.
*THE PRIMARY SHIPPING CARTON WILL BE LABELED "COMPLIANT TO RoHS DIRECTIVE 2002/95/EC AND ELV ANNEX II OF DIRECTIVE 2000/53/EC."
CARTONS WITHOUT THIS LABEL MAY CONTAIN PRODUCT WITH TIN-LEAD IN THE PC TAILS.
 - PRODUCT SPECIFICATION AND PROCESSING PARAMETERS:** PS-43860-003.
 - PACKAGING SPECIFICATION:**
SPECIFICATION PK-44248-004.
CONNECTOR ASSEMBLIES IN THERMOFORMED TRAYS PER MOLEX PACKAGING.
 - APPLICATION SPECIFICATION:** AS-43860-001
 - ALL UNTOLERANCED DIMENSIONS ARE SHOWN FOR REFERENCE ONLY.
 - CONFORMS TO FCC REGULATION PART 68.5 FOR MODULAR JACKS.
 - MODJACKS AVAILABLE WITH EITHER SNAP-FIT OR PRESS-FIT PEGS.
THIS DRAWING SHOWS SNAP-FIT PEGS.
 - PCB LAYOUT AND PANEL CUT-OUT SHOWN ON SHEETS (5) AND (6).
 - THIS PART CONFORMS TO CLASS B REQUIREMENTS OF COSMETIC SPECIFICATION PS-45499-002.

UNSHIELDED
WITH LIGHT PIPES

CHGD 0117 TO 0119 IEC NO: UCP2009-1482 DRAWN: KLOSTNER 2008/12/10 CHKD: BELL 2008/12/10 APPROVED: SMITH 2008/12/10 REV 4	QUALITY SYMBOLS ▽=0 ▽=0	GENERAL TOLERANCES (UNLESS SPECIFIED): <table border="1"> <thead> <tr> <th></th> <th>mm</th> <th>INCH</th> </tr> </thead> <tbody> <tr> <td>4 PLACES</td> <td>±.010</td> <td>±.0004</td> </tr> <tr> <td>3 PLACES</td> <td>±.015</td> <td>±.0006</td> </tr> <tr> <td>2 PLACES</td> <td>±.025</td> <td>±.0010</td> </tr> <tr> <td>1 PLACE</td> <td>±.050</td> <td>±.0020</td> </tr> </tbody> </table> ANGULAR ±1/2°		mm	INCH	4 PLACES	±.010	±.0004	3 PLACES	±.015	±.0006	2 PLACES	±.025	±.0010	1 PLACE	±.050	±.0020	DIMENSION STYLE IN/MM	SCALE 4:1	DESIGN UNITS INCH	THIRD ANGLE PROJECTION
		mm	INCH																		
	4 PLACES	±.010	±.0004																		
	3 PLACES	±.015	±.0006																		
2 PLACES	±.025	±.0010																			
1 PLACE	±.050	±.0020																			
DRAWN BY: MMAYO CHECKED BY: JROBERTS APPROVED BY: JROBERTS	DATE: 98/10/06 DATE: 98/10/06 DATE: 98/10/06	TITLE GANGED INVERTED MODJACK ASSEMBLY	MOLEX INCORPORATED																		
DRAFT WHERE APPLICABLE MUST REMAIN WITHIN DIMENSIONS		MATERIAL NO. SEE CHART	DOCUMENT NO. SD-44248-001	SHEET NO. 1 OF 6	THIS DRAWING CONTAINS INFORMATION THAT IS PROPRIETARY TO MOLEX INCORPORATED AND SHOULD NOT BE USED WITHOUT WRITTEN PERMISSION																

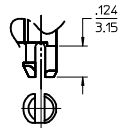

SNAP-FIT PEG OPTION

SCALE: NTS.
SEE NOTE #8

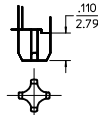

PRESS-FIT PEG OPTION

SCALE: NTS.
SEE NOTE #8

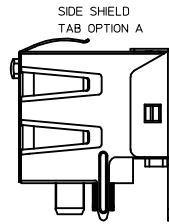

SIDE SHIELD TAB OPTION B

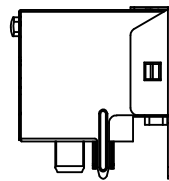

(8) CIRCUIT HOUSING(S)							
ASSEMBLY MATERIAL NUMBER	NUMBER OF CIRCUITS	NUMBER OF PORTS	PEG STYLE	SIDE SHIELD TAB OPTION	DIM -A-	DIM -B-	DIM -C-
44248-0029	8	2	SNAP-FIT	A	1.274/32.36	1.120/28.45	.469/11.92
44248-0030	8	4	SNAP-FIT	A	2.514/63.86	2.360/59.94	.469/11.92
44248-0033	8	2	PRESS-FIT	A	1.274/32.36	1.120/28.45	.469/11.92
44248-0034	8	4	PRESS-FIT	A	2.514/63.86	2.360/59.94	.469/11.92

(6) CIRCUIT HOUSING(S)							
ASSEMBLY MATERIAL NUMBER	NUMBER OF CIRCUITS	NUMBER OF PORTS	PEG STYLE	SIDE SHIELD TAB OPTION	DIM -A-	DIM -B-	DIM -C-
44248-0037	6	2	SNAP-FIT	A	1.274/32.36	1.120/28.45	.389/9.88
44248-0038	4	2	SNAP-FIT	A	1.274/32.36	1.120/28.45	.389/9.88
44248-0039	6	4	SNAP-FIT	A	2.514/63.86	2.360/59.94	.389/9.88
44248-0040	4	4	SNAP-FIT	A	2.514/63.86	2.360/59.94	.389/9.88
44248-0045	6	2	PRESS-FIT	A	1.274/32.36	1.120/28.45	.389/9.88
44248-0046	4	2	PRESS-FIT	A	1.274/32.36	1.120/28.45	.389/9.88
44248-0047	6	4	PRESS-FIT	A	2.514/63.86	2.360/59.94	.389/9.88
44248-0048	4	4	PRESS-FIT	A	2.514/63.86	2.360/59.94	.389/9.88

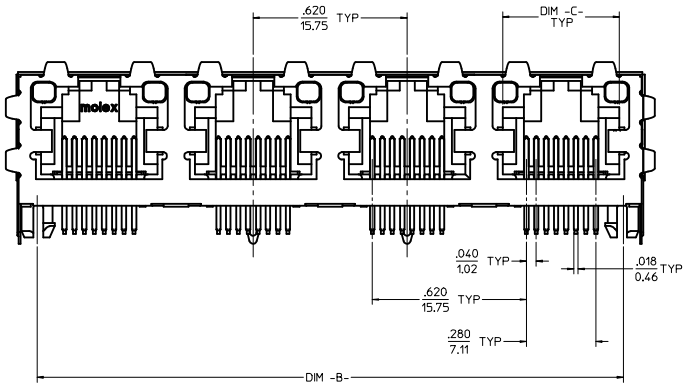
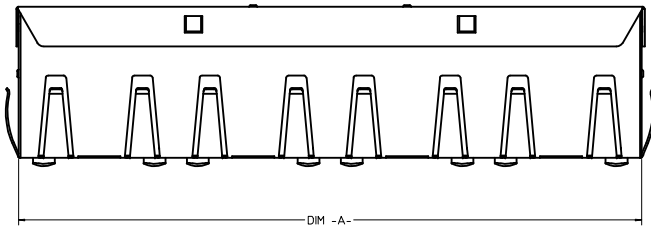

OPTIONAL SIDE SHIELD TABS SEE CHARTS

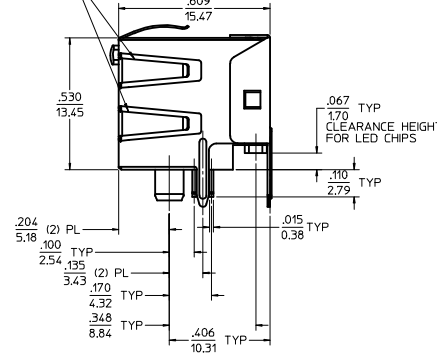

- NOTES:
- MATERIAL: HOUSING: POLYESTER(PBT), GLASS FILLED, UL94V-0, COLOR: BLACK
LIGHT PIPES: POLYCARBONATE, UL-94V2, COLOR: CLEAR
TERMINALS: PHOSPHOR BRONZE
SHIELD: BRASS
 - FINISH: TERMINALS:
*SELECT GOLD IN CONTACT AREA: 50 MICROINCHES (1.27 MICROMETERS) MIN.
*SELECT TIN IN PC TAIL AREA: 100 MICROINCHES (2.54 MICROMETERS) MIN,
WITH OVERALL NICKEL UNDERPLATE: 50 MICROINCHES (1.27 MICROMETERS) MIN.
SHIELD:
*100 MICROINCHES (2.54 MICROMETERS) NICKEL OVER 50 MICROINCHES (1.27 MICROMETERS) COPPER UNDERPLATE PCB GROUND TABS DIPPED IN TIN
*THE PRIMARY SHIPPING CARTON WILL BE LABELED "COMPLIANT TO RoHS DIRECTIVE 2002/95/EC AND ELV ANNEX II OF DIRECTIVE 2000/53/EC".
CARTONS WITHOUT THIS LABEL MAY CONTAIN PRODUCT WITH TIN-LEAD IN THE PC TAILS AND/OR SHIELD.
 - PRODUCT SPECIFICATION AND PROCESSING PARAMETERS: PS-43860-003.
 - PACKAGING SPECIFICATION:
CONNECTOR ASSEMBLIES IN THERMOFORMED TRAYS PER MOLEX PACKAGING SPECIFICATION PK-44248-004.
 - APPLICATION SPECIFICATION: AS-43860-001
 - ALL UNTOLERANCED DIMENSIONS ARE SHOWN FOR REFERENCE ONLY.
 - CONFORMS TO FCC REGULATION PART 68.5 FOR MODULAR JACKS.
 - MODJACKS AVAILABLE WITH EITHER SNAP-FIT OR PRESS-FIT PEGS.
THIS DRAWING SHOWS SNAP-FIT PEGS.
 - PCB LAYOUT AND PANEL CUT-OUT SHOWN ON SHEETS (5) AND (6).
 - THIS PART CONFORMS TO CLASS B REQUIREMENTS OF COSMETIC SPECIFICATION PS-45499-002.

SHIELDED WITH LIGHT PIPES

SEE SHEET 1 IEC NO: UCP2009-1482 DRAWN: KLOSTNER/ER 2008/12/10 CHKD: BELL 2008/12/10 APPROVED: SMITH 2008/12/10 REV DESCRIPTION	QUALITY SYMBOLS ▽=0 ▽=0	GENERAL TOLERANCES (UNLESS SPECIFIED): DIMENSION STYLE: IN/MM SCALE: 4:1 DESIGN UNITS: INCH THIRD ANGLE PROJECTION	DRAWN BY: MMAYO 98/10/06 CHECKED BY: JROBERTS 98/10/06 APPROVED BY: JROBERTS 98/10/06	DATE: 98/10/06 DATE: 98/10/06 DATE: 98/10/06	TITLE: GANGED INVERTED MODJACK ASSEMBLY	
	4 PLACES ±.010 INCH 3 PLACES ±.010 INCH 2 PLACES ±.025 INCH 1 PLACE ±.010 INCH ANGULAR ±1/2°	DRAFT WHERE APPLICABLE MUST REMAIN WITHIN DIMENSIONS	MATERIAL NO. SEE CHART DOCUMENT NO. SD-44248-001 SHEET NO. 2 OF 6	MOLEX INCORPORATED		
	THIS DRAWING CONTAINS INFORMATION THAT IS PROPRIETARY TO MOLEX INCORPORATED AND SHOULD NOT BE USED WITHOUT WRITTEN PERMISSION					
	MOLEX INCORPORATED					



SNAP-FIT PEG OPTION
SCALE: NTS,
SEE NOTE #7

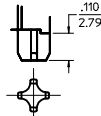

PRESS-FIT PEG OPTION
SCALE: NTS,
SEE NOTE #7

8 CIRCUIT HOUSING(S)						
ASSEMBLY MATERIAL NUMBER	NUMBER OF CIRCUITS	NUMBER OF PORTS	PEG STYLE	DIM -A-	DIM -B-	DIM -C-
44248-0057	8	2	SNAP-FIT	1.250/31.75	1.120/28.45	.469/11.92
44248-0058	8	4	SNAP-FIT	2.490/63.25	2.360/59.94	.469/11.92
44248-0061	8	2	PRESS-FIT	1.250/31.75	1.120/28.45	.469/11.92
44248-0062	8	4	PRESS-FIT	2.490/63.25	2.360/59.94	.469/11.92

6 CIRCUIT HOUSING(S)						
ASSEMBLY MATERIAL NUMBER	NUMBER OF CIRCUITS	NUMBER OF PORTS	PEG STYLE	DIM -A-	DIM -B-	DIM -C-
44248-0065	6	2	SNAP-FIT	1.250/31.75	1.120/28.45	.389/9.88
44248-0066	4	2	SNAP-FIT	1.250/31.75	1.120/28.45	.389/9.88
44248-0067	6	4	SNAP-FIT	2.490/63.25	2.360/59.94	.389/9.88
44248-0068	4	4	SNAP-FIT	2.490/63.25	2.360/59.94	.389/9.88
44248-0073	6	2	PRESS-FIT	1.250/31.75	1.120/28.45	.389/9.88
44248-0074	4	2	PRESS-FIT	1.250/31.75	1.120/28.45	.389/9.88
44248-0075	6	4	PRESS-FIT	2.490/63.25	2.360/59.94	.389/9.88
44248-0076	4	4	PRESS-FIT	2.490/63.25	2.360/59.94	.389/9.88

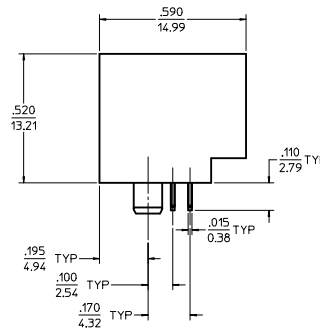
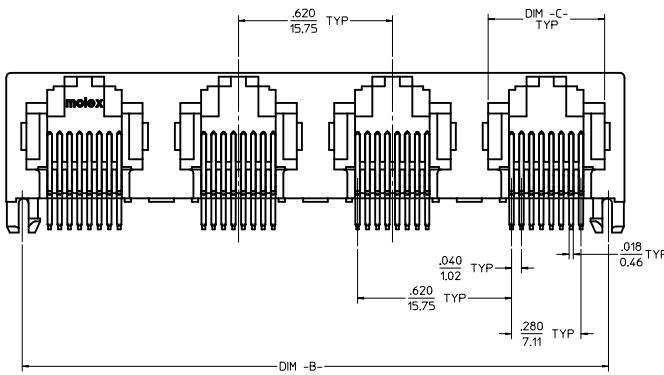

- NOTES:
 1) MATERIAL:
 HOUSING: POLYESTER(PBT), GLASS FILLED, UL94V-0, COLOR: BLACK
 TERMINALS: PHOSPHOR BRONZE
 2) FINISH:
 TERMINALS:
 *SELECT GOLD IN CONTACT AREA: 50 MICROINCHES (1.27 MICROMETERS) MIN.
 *SELECT TIN IN PC TAIL AREA: 100 MICROINCHES (2.54 MICROMETERS) MIN.
 WITH OVERALL NICKEL UNDERPLATE: 50 MICROINCHES (1.27 MICROMETERS) MIN.
 *THE PRIMARY SHIPPING CARTON WILL BE LABELED "COMPLIANT TO RoHS DIRECTIVE 2002/95/EC AND ELV ANNEX II OF DIRECTIVE 2000/53/EC". CARTONS WITHOUT THIS LABEL MAY CONTAIN PRODUCT WITH TIN-LEAD IN THE PC TAILS.
 3) PRODUCT SPECIFICATION AND PROCESSING PARAMETERS: PS-43860-003.
 4) PACKAGING SPECIFICATION:
 CONNECTOR ASSEMBLIES IN THERMOFORMED TRAYS PER MOLEX PACKAGING SPECIFICATION PK-44248-004.
 5) ALL UNTOLERANCED DIMENSIONS ARE SHOWN FOR REFERENCE ONLY.
 6) CONFORMS TO FCC REGULATION PART 68.5 FOR MODULAR JACKS.
 7) MODJACKS AVAILABLE WITH EITHER SNAP-FIT OR PRESS-FIT PEGS. THIS DRAWING SHOWS SNAP-FIT PEGS.
 8) PCB LAYOUT AND PANEL CUT-OUT SHOWN ON SHEETS (5) AND (6).
 9) THIS PART CONFORMS TO CLASS B REQUIREMENTS OF COSMETIC SPECIFICATION PS-45499-002.

UNSHIELDED

SEE SHEET 1 IEC NO: UCP2009-1482 DRAWN: KLOSTERER 2008/12/10 CHYD: BELL 2008/12/10 APPROVED: SMITH 2008/12/10	QUALITY SYMBOLS ▽=0 ▽=0	GENERAL TOLERANCES (UNLESS SPECIFIED) mm INCH 4 PLACES ±.010 ±.010 3 PLACES ±.025 ±.010 2 PLACES ±.050 ±.010 1 PLACE ±.100 ±.010 ANGULAR ±1/2°	DIMENSION STYLE IN/MM DRAWN BY DATE MMAYO 98/10/06 CHECKED BY DATE JROBERTS 98/10/06 APPROVED BY DATE JROBERTS 98/10/06	SCALE 4:1 DESIGN UNITS INCH THIRD ANGLE PROJECTION	TITLE GANGED INVERTED MODJACK ASSEMBLY
	DRAFT WHERE APPLICABLE MUST REMAIN WITHIN DIMENSIONS		MATERIAL NO. SEE CHART	DOCUMENT NO. SD-44248-001	SHEET NO. 3 OF 6
	MOLEX INCORPORATED				
	THIS DRAWING CONTAINS INFORMATION THAT IS PROPRIETARY TO MOLEX INCORPORATED AND SHOULD NOT BE USED WITHOUT WRITTEN PERMISSION				

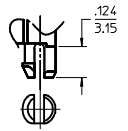

SNAP-FIT PEG OPTION

SCALE: NTS
SEE NOTE #7

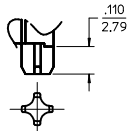

PRESS-FIT PEG OPTION

SCALE: NTS
SEE NOTE #7

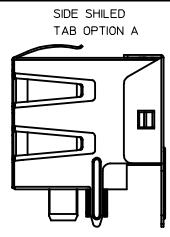

SIDE SHIELDED
TAB OPTION A

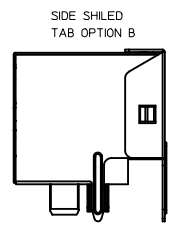

SIDE SHIELDED
TAB OPTION B

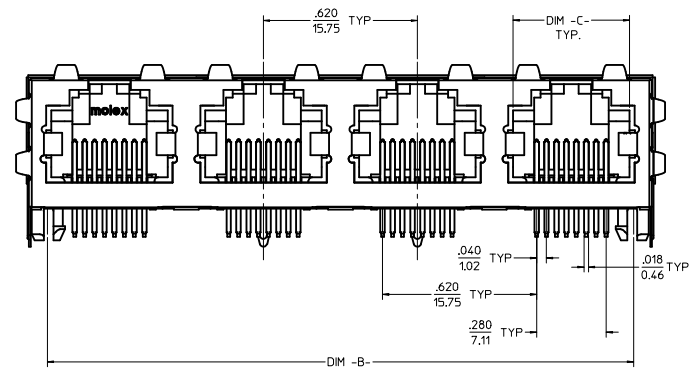
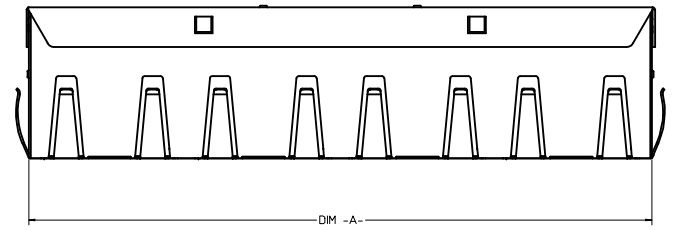

SHIELDED

(8) CIRCUIT HOUSING(S)

X = NOT TOOLED	ASSEMBLY MATERIAL NUMBER	NUMBER OF CIRCUITS	NUMBER OF PORTS	PEG STYLE	SIDE SHIELD TAB OPTION	DIM -A-	DIM -B-	DIM -C-
	44248-0085	8	2	SNAP-FIT	A	1.274/32.36	1.120/28.45	.469/11.92
	44248-0086	8	4	SNAP-FIT	A	2.514/63.86	2.360/59.94	.469/11.92
	44248-0089	8	2	PRESS-FIT	A	1.274/32.36	1.120/28.45	.469/11.92
	44248-0090	8	4	PRESS-FIT	A	2.514/63.86	2.360/59.94	.469/11.92
X	44248-0119	8	4	PRESS FIT	B	2.514/63.86	2.360/59.94	.469/11.92

(6) CIRCUIT HOUSING(S)

ASSEMBLY MATERIAL NUMBER	NUMBER OF CIRCUITS	NUMBER OF PORTS	PEG STYLE	SIDE SHIELD TAB OPTION	DIM -A-	DIM -B-	DIM -C-
44248-0093	6	2	SNAP-FIT	A	1.274/32.36	1.120/28.45	.389/9.88
44248-0094	4	2	SNAP-FIT	A	1.274/32.36	1.120/28.45	.389/9.88
44248-0095	6	4	SNAP-FIT	A	2.514/63.86	2.360/59.94	.389/9.88
44248-0096	4	4	SNAP-FIT	A	2.514/63.86	2.360/59.94	.389/9.88
44248-0101	6	2	PRESS-FIT	A	1.274/32.36	1.120/28.45	.389/9.88
44248-0102	4	2	PRESS-FIT	A	1.274/32.36	1.120/28.45	.389/9.88
44248-0103	6	4	PRESS-FIT	A	2.514/63.86	2.360/59.94	.389/9.88
44248-0104	4	4	PRESS-FIT	A	2.514/63.86	2.360/59.94	.389/9.88

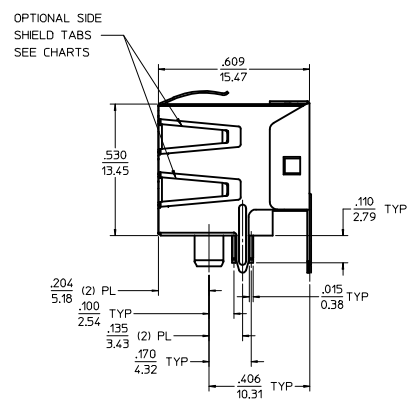

- NOTES:
- MATERIAL: HOUSING: POLYESTER(PBT), GLASS FILLED, UL94V-0, COLOR: BLACK
TERMINALS: PHOSPHOR BRONZE
SHIELD: BRASS
 - FINISH: TERMINALS:
*SELECT GOLD IN CONTACT AREA: 50 MICRONCHES (1.27 MICROMETERS) MIN.
*SELECT TIN IN PC TAIL AREA: 100 MICRONCHES (2.54 MICROMETERS) MIN.
WITH OVERALL NICKEL UNDERPLATE: 50 MICRONCHES (1.27 MICROMETERS) MIN.
SHIELD:
*100 MICRONCHES (2.54 MICROMETERS) NICKEL OVER 50 MICRONCHES (1.27 MICROMETERS) COPPER UNDERPLATE PCB GROUND TABS DIPPED IN TIN
*THE PRIMARY SHIPPING CARTON WILL BE LABELED "COMPLIANT TO RoHS DIRECTIVE 2002/95/EC AND ELV ANNEX II OF DIRECTIVE 2000/53/EC" (CARTONS WITHOUT THIS LABEL MAY CONTAIN PRODUCT WITH TIN-LEAD IN THE PC TAILS AND/OR SHIELD.
 - PRODUCT SPECIFICATION AND PROCESSING PARAMETERS: PS-43860-003.
 - PACKAGING SPECIFICATION: CONNECTOR ASSEMBLIES IN THERMOFORMED TRAYS PER MOLEX PACKAGING SPECIFICATION PK-44248-004.
 - ALL UNTOLERANCED DIMENSIONS ARE SHOWN FOR REFERENCE ONLY.
 - CONFORMS TO FCC REGULATION PART 68.5 FOR MODULAR JACKS.
 - MODJACKS AVAILABLE WITH EITHER SNAP-FIT OR PRESS-FIT PEGS. THIS DRAWING SHOWS SNAP-FIT PEGS.
 - PCB LAYOUT AND PANEL CUT-OUT SHOWN ON SHEETS (5) AND (6).
 - THIS PART CONFORMS TO CLASS B REQUIREMENTS OF COSMETIC SPECIFICATION PS-43499-002.

CHGD 0117 TO 0119 IEC NO: UCP2009-1482 DRAWN: KLOS/TEHLER 2008/12/10 CHKD: BELL 2008/12/10 APPR: F. SMITH 2008/12/10 REV: C4	QUALITY SYMBOLS	GENERAL TOLERANCES (UNLESS SPECIFIED)	DIMENSION STYLE	SCALE	DESIGN UNITS	THIRD ANGLE PROJECTION
	▽=0 ▽=0	mm INCH 4 PLACES ± --- ± --- 3 PLACES ± --- ± .010 2 PLACES ± 0.25 ± --- 1 PLACE ± --- ± --- ANGULAR ±1/2°	IN/MM DATE DRAWN BY: MMAYO 98/10/06 CHECKED BY: JROBERTS 98/10/06 APPROVED BY: JROBERTS 98/10/06	4:1	INCH	TITTLE GANGED INVERTED MODJACK ASSEMBLY
	DRAFT WHERE APPLICABLE MUST REMAIN WITHIN DIMENSIONS	SEE CHART	MATERIAL NO. SD-44248-001	MOLEX INCORPORATED DOCUMENT NO.	SHEET NO. 4 OF 6	
		SIZE D THIS DRAWING CONTAINS INFORMATION THAT IS PROPRIETARY TO MOLEX INCORPORATED AND SHOULD NOT BE USED WITHOUT WRITTEN PERMISSION				

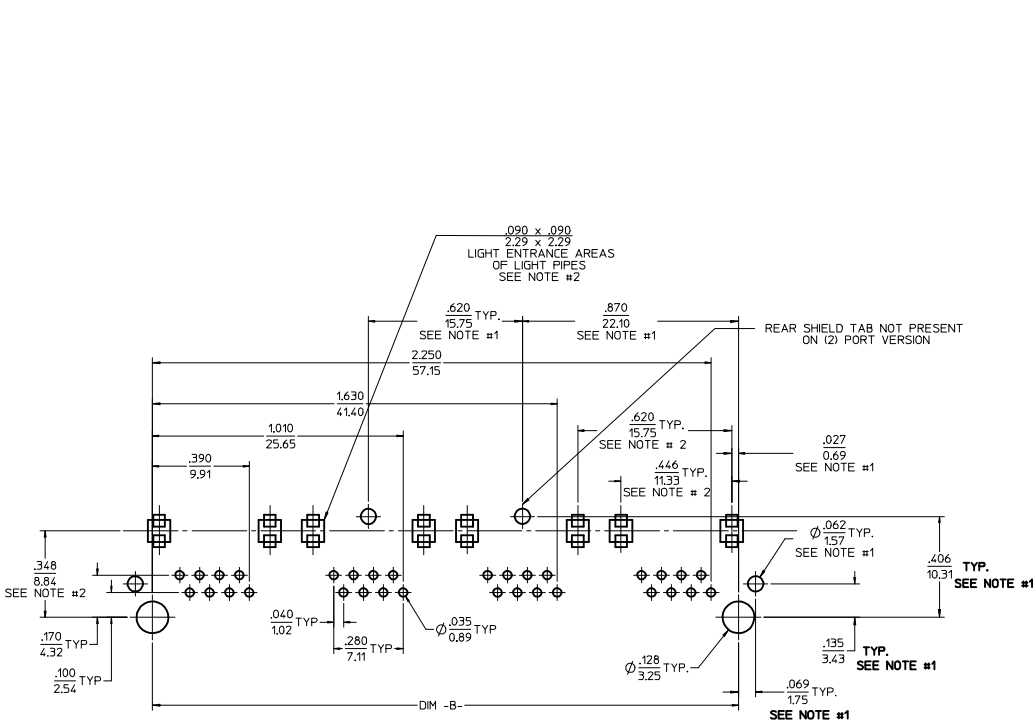

8 CIRCUIT PCB LAYOUT: COMPONENT SIDE
 RECOMMENDED PCB THICKNESS: .062/157
 TOLERANCE ±.003/.076 UNLESS OTHERWISE SPECIFIED

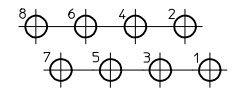
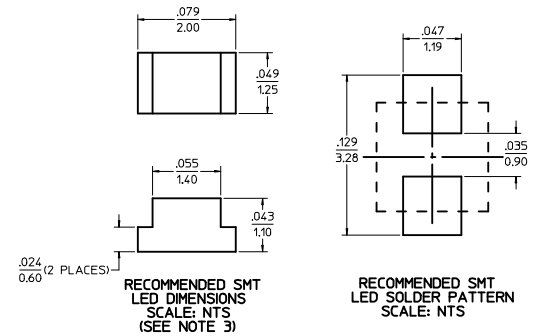

TYPICAL PC TERMINAL HOLE LAYOUT
 (8) CIRCUIT CONFIGURATION
 SCALE: 10:1

- NOTES:
- 1) DIMENSIONS MARKED "SEE NOTE #1" REFER TO ASSEMBLIES WITH THE SHIELDING OPTION INCLUDED
 - 2) DIMENSIONS MARKED "SEE NOTE #2" REFER TO ASSEMBLIES WITH THE LIGHT PIPE OPTION INCLUDED
 - 3) FOR CROSS REFERENCE OF RECOMMENDED LEADS SEE MOLEX WEB SITE.

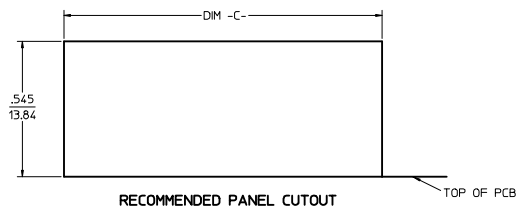

NUMBER OF PORTS	DIM -B-	DIM -C-
2	1.120/28.45	1.280/32.51
4	2.360/59.94	2.520/64.01

SEE SHEET 1 IEC NO: LCP2009-1482 DRAWN: KLOSTNER 2008/12/10 CHKD: BELL 2008/12/10 APPROVED: SMITH 2008/12/10 REV: 4	QUALITY SYMBOLS	GENERAL TOLERANCES (UNLESS SPECIFIED)	DIMENSION STYLE	SCALE	DESIGN UNITS	THIRD ANGLE PROJECTION	
	▼=0 ▽=0	mm INCH 4 PLACES ± --- ± --- 3 PLACES ± --- ± .010 2 PLACES ± 0.25 ± --- 1 PLACE ± --- ± --- ANGULAR ±1/2°	IN/MM 4:1 INCH	DRAWN BY: MMAYO CHECKED BY: JROBERTS APPROVED BY: JROBERTS DATE: 98/10/06 DATE: 98/10/06 DATE: 98/10/06	TITLE: GANGED INVERTED MODJACK ASSEMBLY	MOLEX MOLEX INCORPORATED	MATERIAL NO: N/A DOCUMENT NO: SD-44248-001
	DRAFT WHERE APPLICABLE MUST REMAIN WITHIN DIMENSIONS	SIZE: D	THIS DRAWING CONTAINS INFORMATION THAT IS PROPRIETARY TO MOLEX INCORPORATED AND SHOULD NOT BE USED WITHOUT WRITTEN PERMISSION	SHEET NO: 5 OF 6			

