

**PLEASE CHECK WWW.MOLEX.COM FOR LATEST PART INFORMATION**

**Part Number:** [0878321816](#)  
**Status:** **Active**  
**Overview:** milligrid  
**Description:** 2.00mm (.079") Pitch Milli-Grid™ Header, Surface Mount, Vertical, Shrouded, Lead-free, 18 Circuits, 0.38µm (15µ") Gold (Au) Plating, with Locking Windows, Center Polarization Slot, Cap, without PCB Locator, Tube

**Documents:**

[3D Model](#) [Product Specification PS-87831-027 \(PDF\)](#)  
[Drawing \(PDF\)](#) [RoHS Certificate of Compliance \(PDF\)](#)

**Agency Certification**

CSA LR19980  
 UL E29179

**General**

Product Family PCB Headers  
 Series [87832](#)  
 Application Wire-to-Board  
 Comments With Cap|Contact Molex for application in automotive industry  
 Overview [milligrid](#)  
 Product Name Milli-Grid™

**Physical**

Breakaway No  
 Circuits (Loaded) 18  
 Circuits (maximum) 18  
 Color - Resin Black  
 First Mate / Last Break No  
 Flammability 94V-0  
 Glow-Wire Compliant No  
 Guide to Mating Part No  
 Keying to Mating Part Yes  
 Lock to Mating Part Yes  
 Material - Metal Phosphor Bronze  
 Material - Plating Mating Gold  
 Material - Plating Termination Tin  
 Material - Resin Nylon  
 Number of Rows 2  
 Orientation Vertical  
 PCB Locator No  
 PCB Retention None  
 Packaging Type Tube  
 Pitch - Mating Interface (in) 0.079 In  
 Pitch - Mating Interface (mm) 2.00 mm  
 Pitch - Term. Interface (in) 0.079 In  
 Pitch - Term. Interface (mm) 2.00 mm  
 Plating min: Mating (µin) 15  
 Plating min: Mating (µm) 0.38  
 Plating min: Termination (µin) 75  
 Plating min: Termination (µm) 1.88  
 Polarized to Mating Part Side Slots (2)  
 Polarized to PCB No  
 Shrouded Fully  
 Stackable No



image - Reference only

**EU RoHS**

**ELV and RoHS Compliant**  
**REACH SVHC Contains SVHC: No**  
**Halogen-Free Status**  
**Not Reviewed**

**China RoHS**



**Need more information on product environmental compliance?**

Email [productcompliance@molex.com](mailto:productcompliance@molex.com)  
 For a multiple part number RoHS Certificate of Compliance, [click here](#)

Please visit the [Contact Us](#) section for any non-product compliance questions.

**Search Parts in this Series**

[87832Series](#)

**Mates With**

[50394](#) Wire-to-Board Terminals. [51110](#) Wire-to-Board Crimp Housing. [87568](#) Wire-to-Board IDT Housings. [79107](#) Board-to-Board Top Entry Through Hole Receptacle. [79108](#) Board-to-Board FFC/FPC Top Entry Through Hole Receptacle. L

Temperature Range - Operating	-55°C to +105°C
Termination Interface: Style	Surface Mount

### **Electrical**

Current - Maximum per Contact	2A
Voltage - Maximum	125V

### **Solder Process Data**

Duration at Max. Process Temperature (seconds)	10
Lead-free Process Capability	Reflow Capable (SMT only)
Max. Cycles at Max. Process Temperature	1
Process Temperature max. C	260

### **Material Info**

### **Reference - Drawing Numbers**

Product Specification	PS-87831-027
Sales Drawing	SD-87832-008

This document was generated on 05/25/2010

**PLEASE CHECK [WWW.MOLEX.COM](http://WWW.MOLEX.COM) FOR LATEST PART INFORMATION**

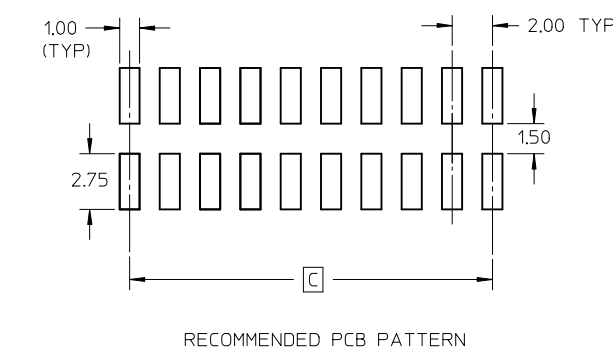
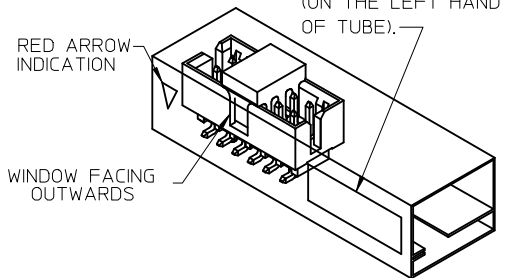
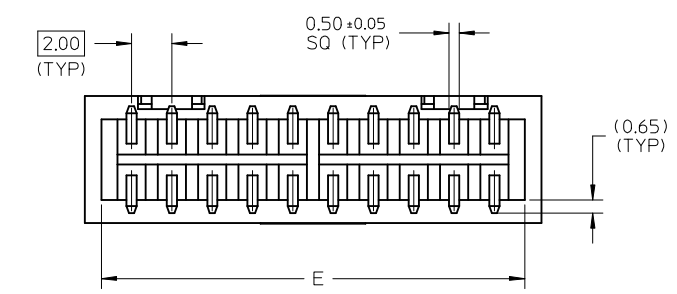
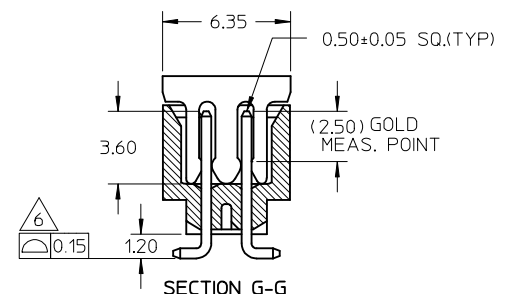
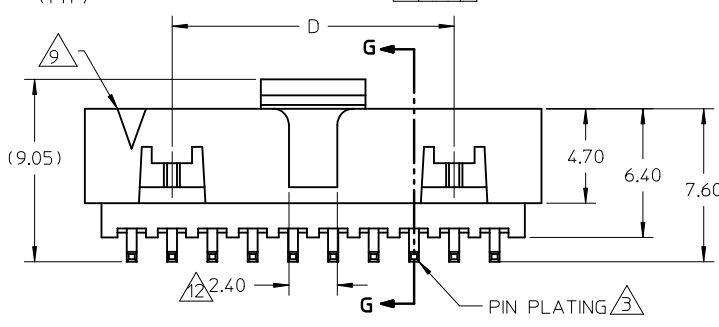
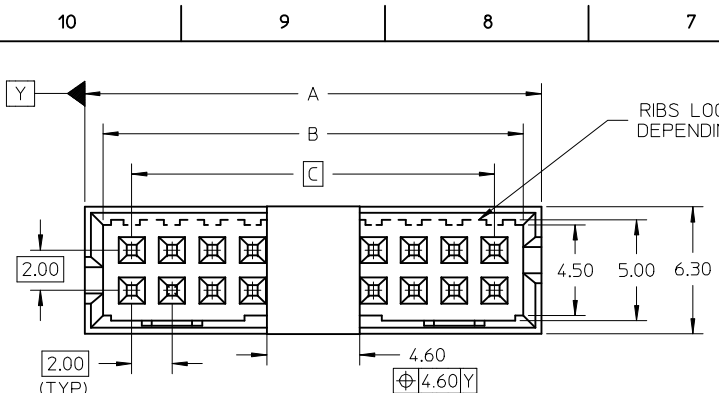

P/N	W/CAP IN TUBE	P/N	W/CAP IN T&R	P/N	W/O CAP IN TUBE	CKT SIZE	DIMENSION				
							A	B	C	D	E
87832-0616	87832-0614	87832-0612	87832-0612	6	8.65	6.85	4.00	---	7.00		
87832-0816	87832-0814	87832-0812	87832-0812	8	10.65	8.85	6.00	---	9.00		
87832-1416	87832-1414	87832-1412	87832-1412	14	16.65	14.85	12.00	8.00	15.00		
87832-1816	87832-1814	87832-1812	87832-1812	18	20.65	18.85	16.00	12.00	19.00		
87832-2016	87832-2014	87832-2012	87832-2012	20	22.65	20.85	18.00	14.00	21.00		
87832-2616	---	87832-2612	87832-2612	26	28.65	26.85	24.00	20.00	27.00		
87832-3016	87832-3014	87832-3012	87832-3012	30	32.65	30.85	28.00	24.00	31.00		
87832-3416	87832-3414	87832-3412	87832-3412	34	36.65	34.85	32.00	28.00	35.00		
87832-4016	---	87832-4012	87832-4012	40	42.65	40.85	38.00	34.00	41.00		
87832-5016	---	87832-5012	87832-5012	50	52.65	50.85	48.00	44.00	51.00		
87832-1016	87832-1014	87832-1012	87832-1012	10	12.65	10.85	8.00	---	11.00		
87832-1616	87832-1614	87832-1612	87832-1612	16	18.65	16.85	14.00	10.00	17.00		

- NOTES:
- FOR ILLUSTRATION PURPOSES, 20 CIRCUIT SIZE WAFER IS SHOWN.
  - MATERIAL :  
HOUSING & CAP : NYLON 46, GLASS FILLED, UL94V-0, COLOR BLACK.  
PIN : 0.50MM SQ.PHOSPHOR BRONZE.
  - PLATING:  
0.38um/15uin GOLD IN CONTACT AREA AND 1.88um/75uin MIN.TIN IN SOLDER TAIL AREA OVER 1.27um/50uin MIN. NICKEL OVERALL.
  - PIN PUSHOUT FORCE : 0.91 KG MIN. IN EITHER DIRECTION.
  - PRODUCT SPECIFICATION PS-87831-027 APPLIES.
  - COPLANARITY IS TO BE MEASURED BY RESTING THE SOLDER TAIL ON A GAUGE SURFACE.
  - BEND DEPRESSION ON SMT TAIL IS ACCEPTABLE SO LONG AS IT DOES NOT AFFECT THE OVERALL COPLANARITY OF THE TAIL.
  - NO SIDE LOCKING SLOT FROM 6, 8, AND 10 CKT SIZE.
  - CKT 4 & 6 HAS NO IDENTIFICATION TAG.
  - THIS HEADER MATES WITH MOLEX:
    - CRIMP RECEPTACLE HOUSING, 51110 SERIES WITH CRIMP TERMINAL, 50394 SERIES.
    - 2MM MILLIGRID DUAL ROW IDT, 87568 SERIES.
  - PARTS SHALL BE PACKED IN MOISTURE BARRIER BAG WITH DESICCANT GEL.
  - NO CENTRE POLARIZATION SLOT FOR CKT SIZE 6

REF : ORIENTATION OF PART IN TUBE,  
(FOR THE REFERENCE OF PART/TUBE ASSEMBLY.)

ADD IN NOTES NO.12 EC NO: S2009-0943 DRWN:YMCHEONG CHKD:SKANG APPR:MLONG	QUALITY SYMBOLS ▽=0 C=0	GENERAL TOLERANCES (UNLESS SPECIFIED)		DIMENSION STYLE <b>MM ONLY</b>		SCALE <b>NTS</b>	DESIGN UNITS <b>METRIC</b>	THIRD ANGLE PROJECTION		
		mm	INCH	DRAWN BY	DATE	TITLE				
		4 PLACES ± ---	± ---	ATSEE	2003/10/14	<b>MGRID, SHROUDED HEADER W/CAP, IN TUBE AND T&amp;R SMT</b>				
		3 PLACES ± ---	± ---	CHECKED BY	DATE					
2 PLACES ± 0.2	± ---	KCLING	2003/11/07	<b>MOLEX INCORPORATED</b>						
1 PLACE ± ---	± ---	APPROVED BY	DATE							
ANGULAR ± 3 °		SKTOH	2003/11/07	MATERIAL NO.		DOCUMENT NO.				
DRAFT WHERE APPLICABLE MUST REMAIN WITHIN DIMENSIONS		SEE TABLE		SHEET NO.		SD-87832-008				
		SIZE <b>A3</b>		THIS DRAWING CONTAINS INFORMATION THAT IS PROPRIETARY TO MOLEX INCORPORATED AND SHOULD NOT BE USED WITHOUT WRITTEN PERMISSION						

P/N	W/CAP IN T&R	CKT SIZE	W	F	Bo	So	Ao	Ko	TYPE	T&R QUANTITY (PCS/REEL)
87832-0614		06	24.00	11.50	9.15	-	6.40	9.30	A	500
87832-0814		08	24.00	11.50	11.05	-	6.40	9.30	A	
87832-1014		10	24.00	11.50	13.05	-	6.40	9.30	A	
87832-1414		14	32.00	14.20	17.05	28.40	6.40	9.30	C	
87832-1614		16	32.00	14.20	19.05	28.40	6.40	9.30	C	
87832-1814		18	44.00	20.20	21.05	40.40	6.40	9.30	B	
87832-2014		20	44.00	20.20	23.05	40.40	6.40	9.30	C	
87832-3014		30	44.00	20.20	33.05	40.40	6.40	9.30	B	
87832-3414		34	56.00	26.20	37.05	52.40	6.40	9.30	B	

EMBOSSED CARRIER TAPE 'B'

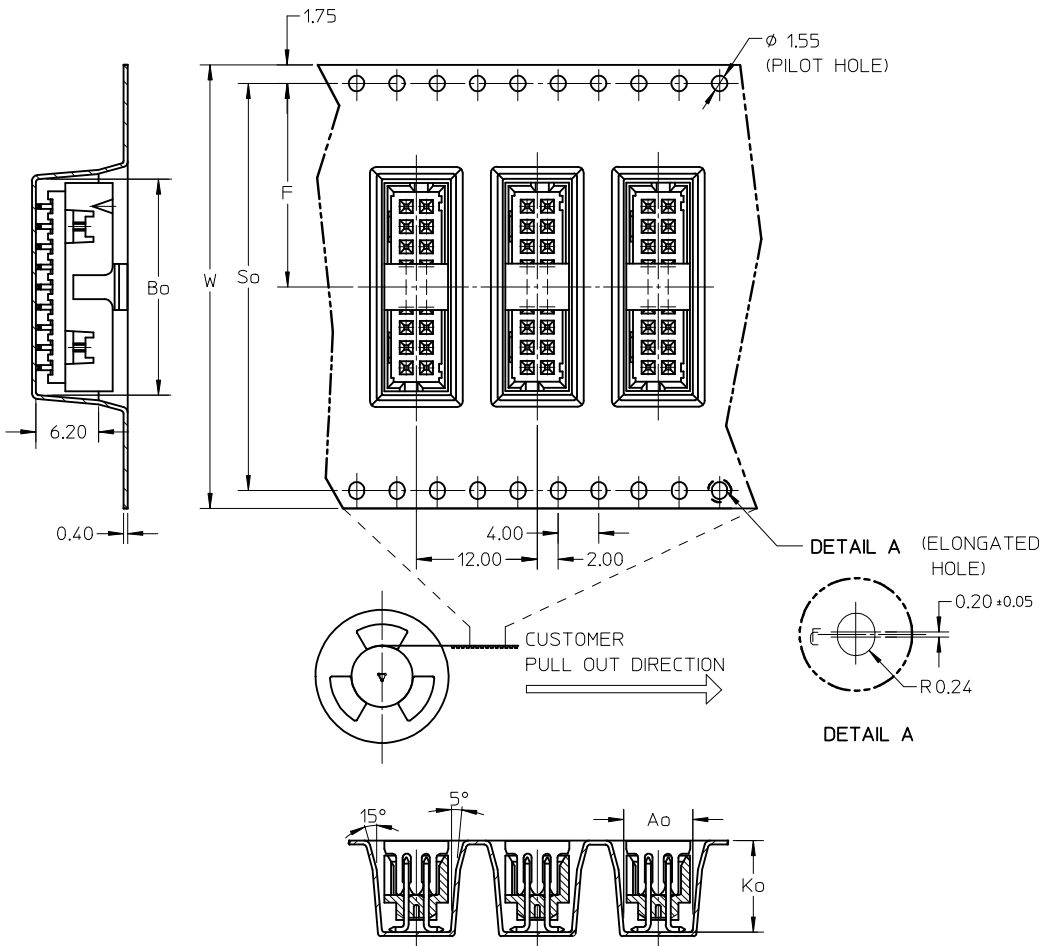

EMBOSSED CARRIER TAPE 'A'

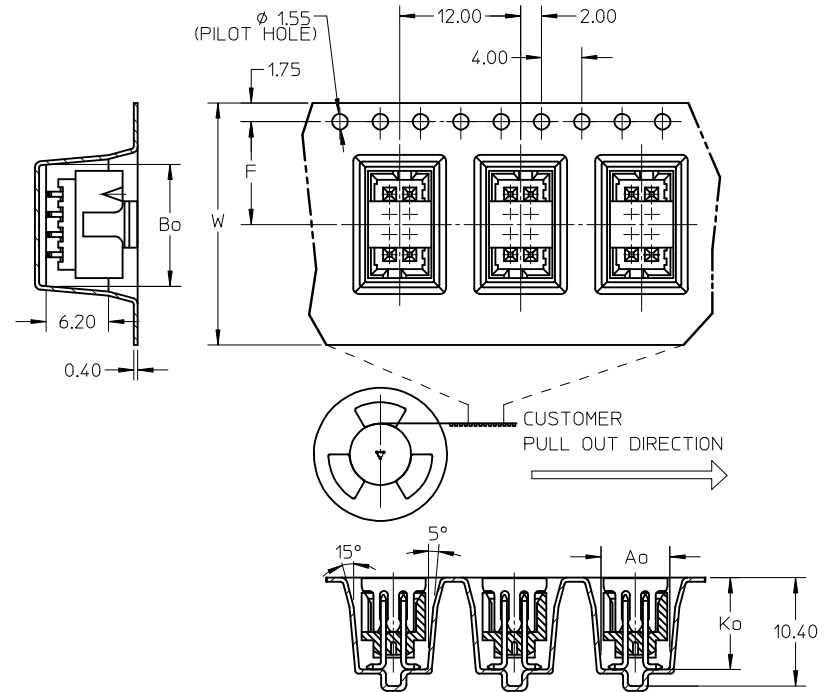

ADD IN NOTES NO.12 EC NO: S2009-0943 DRWN:YMCHONG CHKD:SKANG APPR:MLONG	QUALITY SYMBOLS ▽=0 ◻=0	GENERAL TOLERANCES (UNLESS SPECIFIED)		DIMENSION STYLE MM ONLY		SCALE NTS	DESIGN UNITS METRIC	THIRD ANGLE PROJECTION		
			mm	INCH	DRAWN BY ATSEE	DATE 2003/10/14	TITLE MGRID, SHROUDED HEADER W/CAP, IN TUBE AND T&R SMT			
		4 PLACES	± ---	± ---	CHECKED BY KCL ING	DATE 2003/11/07	MOLEX INCORPORATED			
		3 PLACES	± ---	± ---	APPROVED BY SKTOH	DATE 2003/11/07	DOCUMENT NO. SD-87832-008			
			2 PLACES	± 0.2	± ---	SHEET NO. 2 OF 3				
			1 PLACE	± ---	± ---	THIS DRAWING CONTAINS INFORMATION THAT IS PROPRIETARY TO MOLEX INCORPORATED AND SHOULD NOT BE USED WITHOUT WRITTEN PERMISSION				
			ANGULAR ± 3 °		MATERIAL NO. SEE TABLE					
			DRAFT WHERE APPLICABLE MUST REMAIN WITHIN DIMENSIONS							

EMBOSSED CARRIER TAPE 'C'

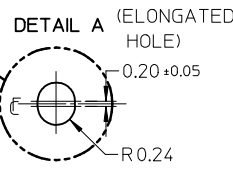
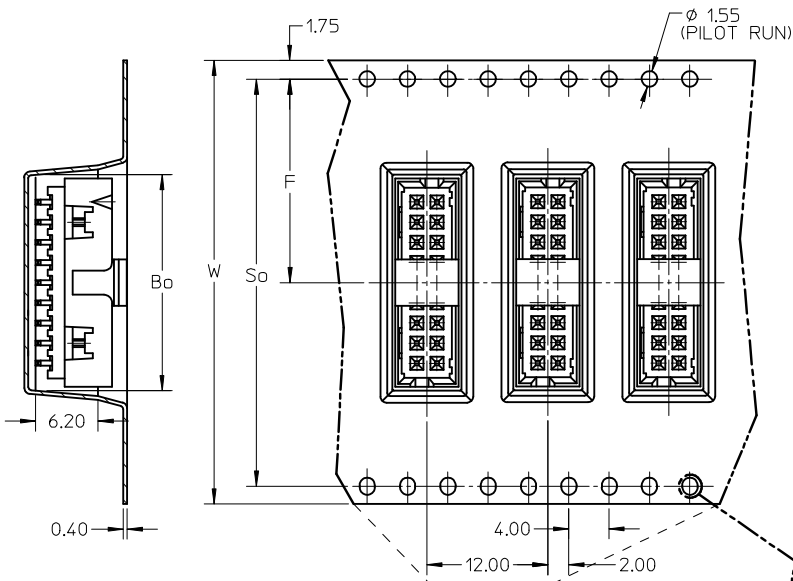

CUSTOMER PULL OUT DIRECTION

NOTES:

1. LEADER AND TRAILER TAPE

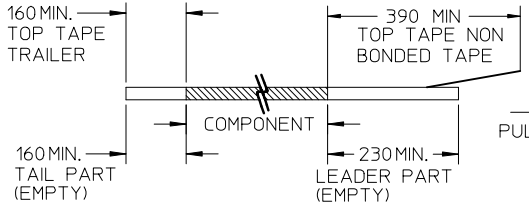

PULL OUT DIRECTION

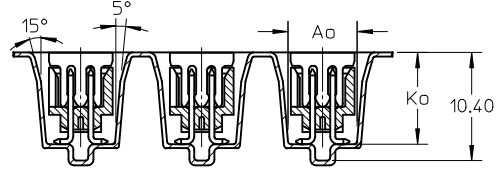

2. PEELING OFF FORCE OF THE TOP TAPE: 20-80gf. (PEELING DIRECTION AS SHOWN IN FOLLOWING FIGURE)

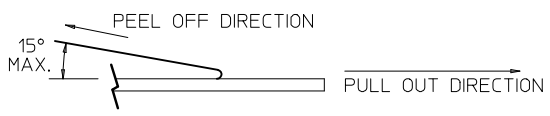

- 3. PACKAGING STANDARD IS AS PER EIA-481.
- 4. TAPE AND REEL QUANTITY = SEE TABLE ON SHEET 2
- 5. THE TAPE IS TREATED FOR ANTI-STATIC.

P/N W/CAP IN TUBE TUBE : 89990-3005	P/N W/O CAP IN TUBE TUBE : 89990-0007
87832-0616	87832-0612
87832-0816	87832-0812
87832-1416	87832-1412
87832-1816	87832-1812
87832-2016	87832-2012
87832-2616	87832-2612
87832-3016	87832-3012
87832-3416	87832-3412
87832-4016	87832-4012
87832-5016	87832-5012
87832-1016	87832-1012
87832-1616	87832-1612

ASSY WITH CAP TUBE

ASSY WITHOUT CAP IN TUBE

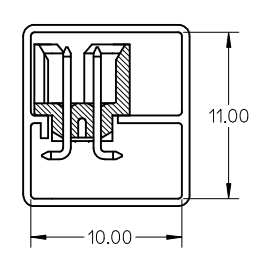
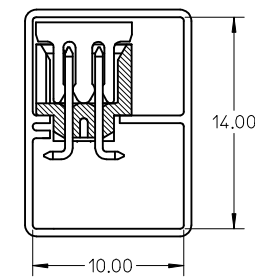
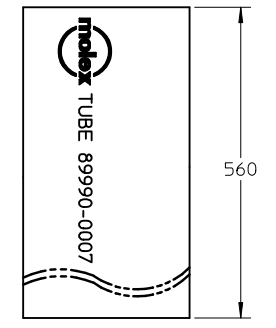
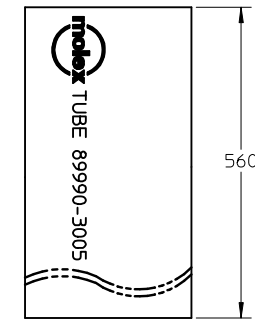

ADD IN NOTES NO.12 EC NO: S2009-0943 DRWN:YMCHEONG CHKD:SKANG APPR:MLONG	2009/07/01	2009/07/08	2009/07/16
	DESCRIPTION		
	QUALITY SYMBOLS	DESCRIPTION	
	▼=0 ◻=0		

GENERAL TOLERANCES (UNLESS SPECIFIED)	mm	INCH
	4 PLACES ± ---	± ---
	3 PLACES ± ---	± ---
	2 PLACES ± 0.2	± ---
	1 PLACE ± ---	± ---
ANGULAR ± 3 °		
DRAFT WHERE APPLICABLE MUST REMAIN WITHIN DIMENSIONS		

DIMENSION STYLE		SCALE	DESIGN UNITS	THIRD ANGLE PROJECTION
MM ONLY		NTS	METRIC	⊙
DRAWN BY	DATE	TITLE		
ATSEE	2003/10/14	MGRID, SHROUDED HEADER W/CAP, IN TUBE AND T&R SMT		
CHECKED BY	DATE	MOLEX INCORPORATED		
KCL ING	2003/11/07	DOCUMENT NO. SD-87832-008		
APPROVED BY	DATE	SHEET NO. 3 OF 3		
SKTOH	2003/11/07	THIS DRAWING CONTAINS INFORMATION THAT IS PROPRIETARY TO MOLEX INCORPORATED AND SHOULD NOT BE USED WITHOUT WRITTEN PERMISSION		
MATERIAL NO.	SEE TABLE			
SIZE	A3			