

108-608 10 Pcs Electronic Combination Wrench

A set of 10 quality combination Spanners manufactured from Chrome-Vanadium steel with a polished chrome plate finish.

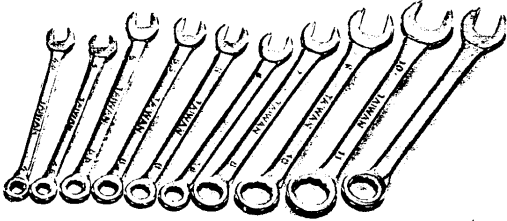

108-608A	Close end	7/16, 11/32, 3/8, 9/32, 5/16, 1/4, 15/64, 7/32, 5/32, 3/16
	inch Size	Open end 3/8, 5/16, 11/32, 1/4, 9/32, 15/64, 7/32, 13/64, 3/16, 5/32
108-608B	Close end	11, 10, 9, 8, 7, 6, 6, 5.5, 4.5, 4
	Metric Size	Open end 10, 9, 8, 7, 6, 5.5, 5, 5, 4, 4.5

1PK-HW024 Adjustable Angle Wrench

Specification:

1. Type: Drop forged, heavy duty, rack and worm adjustment 22.5-degree head wrench.
2. Material: AISI-6140.
3. Hardness: Body, Handle, Jaw all hardness between HRC 40°~50°.
4. Standard: Exceeds in quality the highest demanding international J.I.S., SABS, U.S.A. Federal specification GGG-W-631B ANSI, DIN3117 (G.S. APPROVED NO. 77/94)

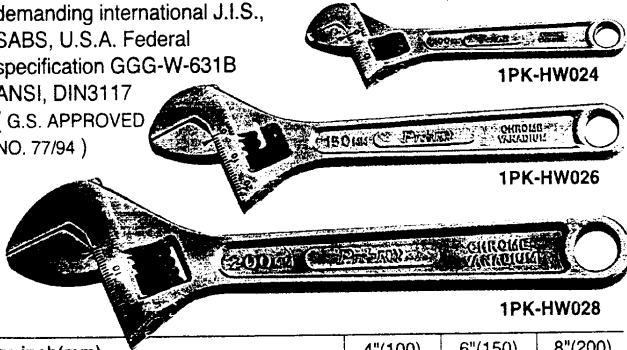
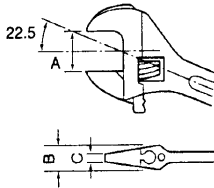

Size inch(mm)	4"(100)	6"(150)	8"(200)
Maximum jaw opening not less than(mm)	13	19.5	24
Overall length(mm)	109	161	208
Weight(grs.)	55	125	255
Load bending test minimum(cm-kgf)	693	1674	3117

1H-024 Adjustable Wrench

Economic type

Model No	OVERALL LENGTH	JAW CAPACITY
1H-024	4"/110mm	1/2" / 13mm
1H-026	6"/155mm	13/16" / 20mm
1H-028	8"/205mm	11/16" / 27mm

108-605A 5 Pcs Needle File Kit

A set of 5 miniature needle files with PVC coated handles. Particularly available for fine work or within restricted areas. Overall length: 170mm, cut length: 95mm

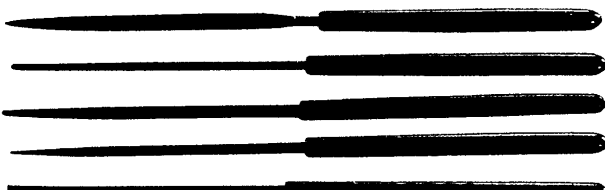

1PK-390 Inspection Mirror

All-angle ball joint mirrors with stainless steel mirror backs. Visual inspection of hidden areas. Double ball joint links swivel mirrors for viewing to 360°. Made of tempered spring steel to move freely and hold desired position. Replaceable, plated, copper-backed, clear-view mirrors, Non-rotating inner hex rods prevent mirrors from swinging out of alignment. Insulating vinyl grip on all models.

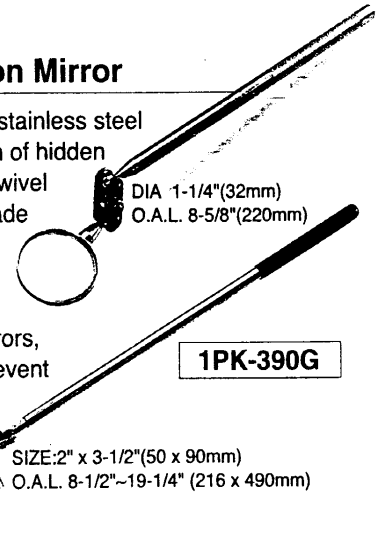

DIA 1-1/4"(32mm)
O.A.L. 8-5/8"(220mm)

1PK-390G

SIZE: 2" x 3-1/2" (50 x 90mm)
O.A.L. 8-1/2"~19-1/4" (216 x 490mm)

8PK-610 PLCC Extractor

A spring assisted clip carrier extraction tool, specially designed for the safe remove of PLCC's from sockets without damage to component parts.

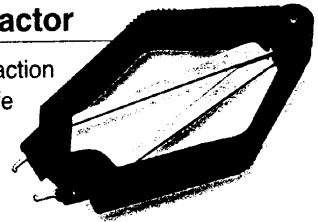

908-609 IC Extractor

A Stainless steel construction for removing dual in-line IC packages. (Insulating vinyl grip.)



908-609A IC Extractor

A Stainless steel construction for removing dual in-line IC packages.



1PK-609D IC Extractor (Heavy Duty W/Adjustable Knob)

A Stainless steel construction for removing dual in-line IC packages.

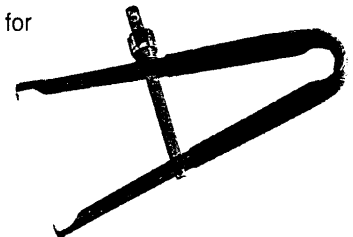

1PK-609NA Anti-Static IC Insert & Extractor Cliper

(For 14-48 pin IC)

