

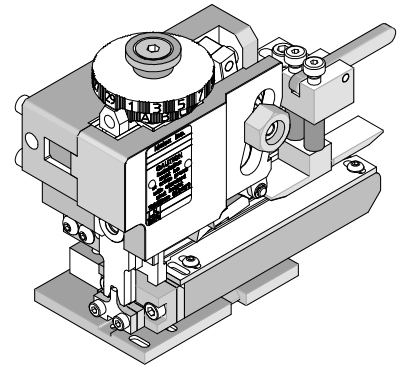

Rear Feed Mini-Mac Applicator Specification Sheet Order No. 63802-6900



FEATURES

- Quick set-up time; plus the crimp height, track and feed adjustments can be preset in applicator
- Conductor and insulation rings allow quick adjustment for conductor and insulation diameter change
- Applicator designed to industry standard mounting and shut height 135.80mm (5.346")
- Directly adapts to most automatic wire processing machines

SCOPE

Products: Krimptite™ Snap Male Plug Terminals 14-18 AWG.

Testing

Mechanical

The tensile test, or pull test, is a means of evaluating the mechanical properties of the crimped connections. The following charts show the UL and government specifications (MIL-T-7928) for various wire sizes. The tensile strength is shown in pounds. It indicates the minimum acceptable force to break or separate the terminal from the conductor.

Wire Size (AWG)	*UL - 486 A	*UL - 486 C	*UL - 310	*Military Class 2
26	3	N/A	N/A	7
24	5	N/A	N/A	10
22	8	8	8	15
20	13	10	13	19
18	20	10	20	38
16	30	15	30	50
14	50	25	50	70
12	70	35	70	110
10	80	40	80	150
8	90	45	N/A	225
6	100	50	N/A	300

*UL - 486 A - Terminals (Copper conductors only)

*UL - 486 C - Butt Splices, Parallel Splices, Closed End Connectors, and Wire Nuts

*UL - 310 - Quick Disconnects, Flag and Couplers

*Military Class 2- Military Approved Terminals only as listed

PRODUCT LIST

The following is a partial list of the product part numbers and their specifications that this tool is designed to run. We will be adding to this list and an up to date copy is available on www.molex.com.

Terminal Series No	Terminal Order No.		Wire Size		Insulation Diameter		Strip Length	
			AWG	mm ²	mm	In.	mm	In.
19724	19724-4000	19724-4002	14-18	2.00-0.80	T 3.96	T .156	5.16	.203
T Maximum Insulation diameter only applicable with splash proof option #19161-0333								

DEFINITION OF TERMS

The following illustrations are a generic terminal representation and not an exact image of any terminal listed in the scope.

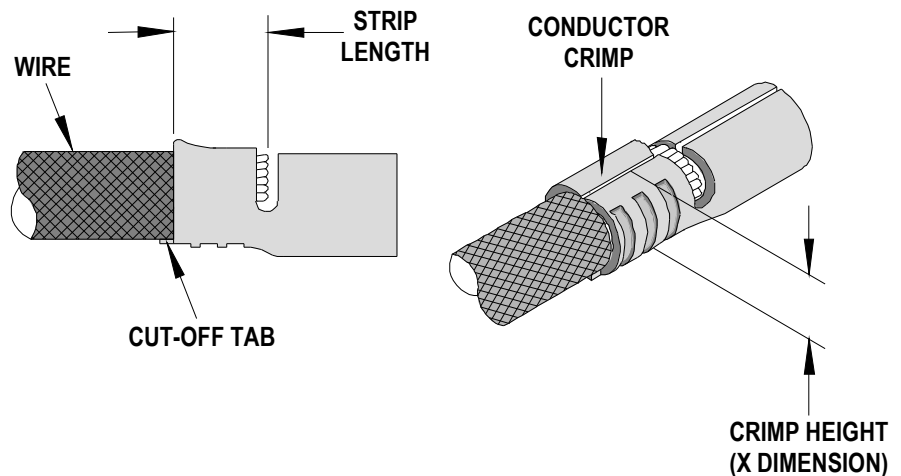

Tool Calibration

1. To recalibrate this applicator, make sure the power is completely shut off on the press.
2. The Mini-Mac applicator must be properly installed in the press.
3. Crimping dies must be properly installed in the Mini-Mac applicator.
4. The recommended method of measuring the crimp height of the conductor dies is the soft metal slug method, (See Figure 1).
5. The slug must have a diameter 0.51mm (.020") larger than the "X" No Go dimension before crimping.
6. Place the soft metal slug (solder) into the nest of the bottom die and crimp (by hand cycling the press) similar to a terminal. The crimp height can be measured with a blade type micrometer or dial caliper, (Dimension "X").
7. Adjustment of the crimp height can be accomplished by indexing the conductor cam. The letter "A" gives the loosest position and "D" gives the tightest position.

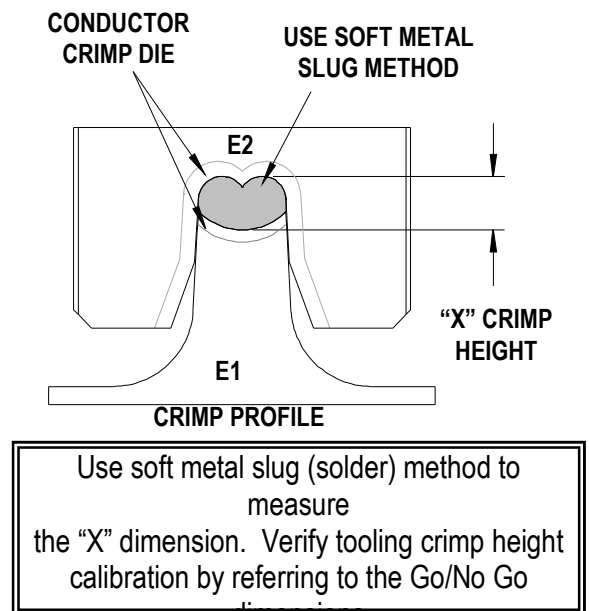

Figure 1

CRIMP SPECIFICATIONS

Terminal Order No	Wire Size		"X" Dimension Conductor Crimp						Pull Force Minimum		Cut-Off Tab Maximum	
			Mean		Go		No Go					
	AWG	mm ²	In	mm	In	mm	In	mm	Lbs	N	In.	mm
19724-4000	14	2.00	.075	1.90	.070	1.77	.080	2.03	50	222.4	.004	.102
	16	1.30	.075	1.90	.070	1.77	.080	2.03	30	133.4	.004	.102
	18	0.80	.069	1.75	.065	1.65	.073	1.85	20	89.0	.004	.102
19724-4002	14	2.00	.075	1.90	.070	1.77	.080	2.03	50	222.4	.004	.102
	16	1.30	.075	1.90	.070	1.77	.080	2.03	30	133.4	.004	.102
	18	0.80	.069	1.75	.065	1.65	.073	1.85	20	89.0	.004	.102

The above specifications are guidelines to an optimum crimp.

PARTS LIST

Mini-Mac Applicator 63802-6900				
Item	Order No	Engineering No.	Description	Quantity
Perishable Tooling				
	63802-6970	63802-6970	Tool Kit (All "Y" Items)	REF
1	63801-5516	63801-5516	Conductor Punch (Upper Die)	1 Y
2	19031-0014	19031-0014	Conductor Anvil (Indenter Die)	1 Y
3	63801-7724	63801-7724	Top Cutter	1 Y
4	19031-0027	19031-0027	Bottom Cutter	1 Y
Other Components				
5	63485-7602	63485-7602	Feed Finger	1
6	63801-4160	63801-4160	Guide R.H.	1
7	63801-4161	63801-4161	Guide L.H.	1
8	63801-5013	63801-5013	Wire Stop	1
9	63801-7151	63801-7151	Terminal Track	1
10	63803-5140	63803-5140	Conductor Bushing 5.20mm Long	1
Frame				
11	63801-2600	63801-2600	Rear Feed Applicator Frame Head	1
12	63801-2603	63801-2603	Base	1
13	63801-7160	63801-7160	Terminal Drag Assembly	1
Hardware				
14	N/A	N/A	M4 by 8 Long SHCS	2**
15	N/A	N/A	M4 by 10 Long SHCS	1**
16	N/A	N/A	M4 by 8 Long BHCS	4**
17	N/A	N/A	M5 by 12 Long BHCS	2**
18	N/A	N/A	M5 by 35 Long SHCS	2**
19	N/A	N/A	M6 by 10 Long BHCS	4**
20	N/A	N/A	M6 by 12 Long BHCS	2**
21	N/A	N/A	M8 by 20 Long BHCS	1**
22	N/A	N/A	M8 Flat Washer	1**
** Available from an industrial supply company such as MSC (1-800-645-7270).				

Assembly Drawing

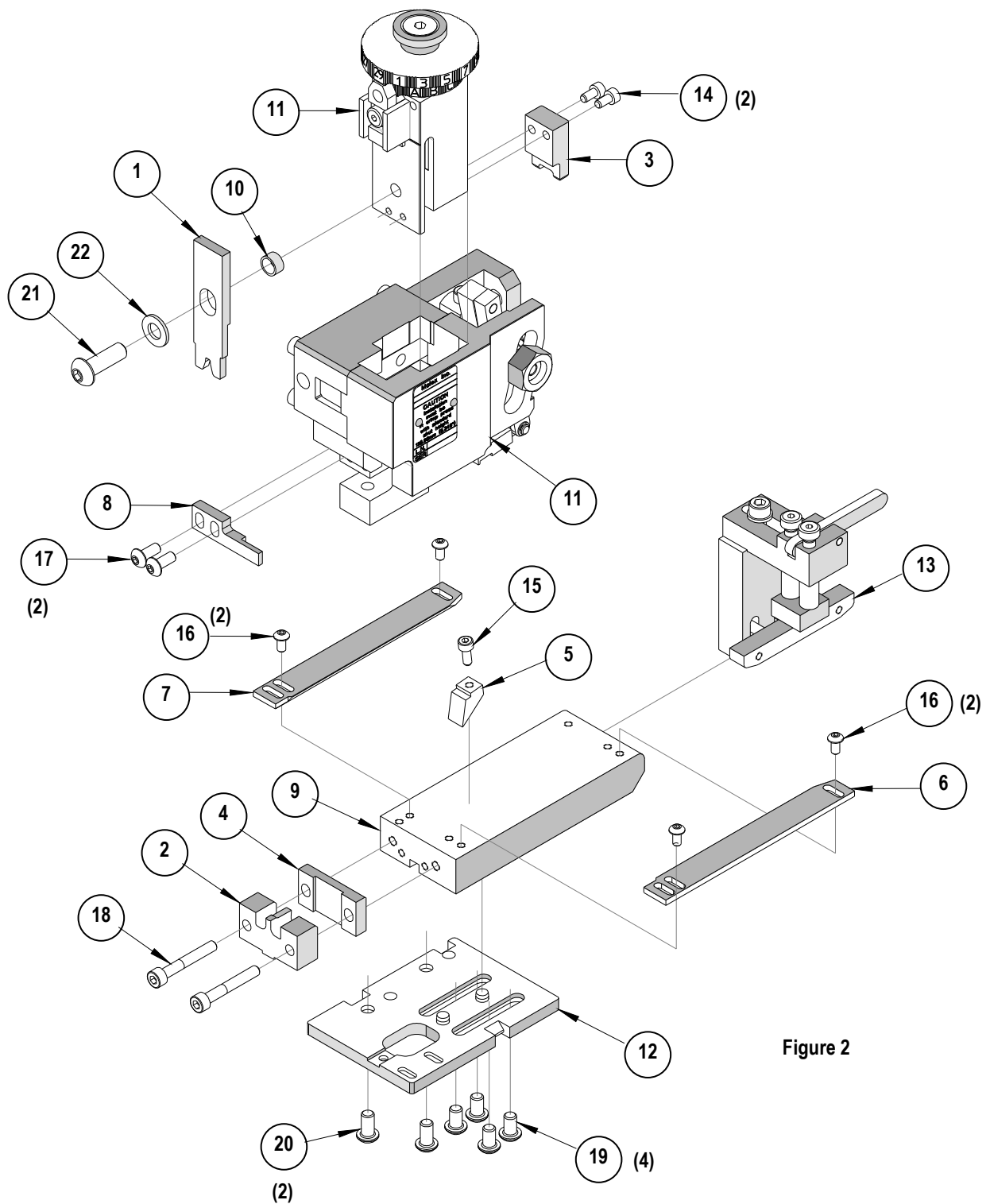

Figure 2

NOTES

1. Molex recommends an extra perishable tooling kit be maintained at your facility.
2. Verify tooling alignment by manually cycling the press and Applicator before crimping under power. Check that all screws are tight.
3. Slugs, Terminals, Dirt and Oil should be kept clear of work area.
4. Wear safety glasses at all times.
5. For recommended maintenance refer to the MiniMac Manual.

CAUTION: This applicator should only be used in a press with a shut height of 135.8 mm (5.346"). Tooling damage could result at a lower setting.

CAUTION: To prevent injury never operate this Applicator without the guards supplied with the press or wire-processing machine in place. Reference the press or wire processing manufacturer's instruction manual.

CAUTION: Molex crimp specifications are valid only when used with Molex terminals, applicators and tooling.

Contact Information

For more information on Molex application tooling please contact Molex at 1-800-786-6539.

Americas Headquarters
Lisle, Illinois 60532 U.S.A.
1-800-78MOLEX
amerinfo@molex.com

Far East North Headquarters
Yamato, Kanagawa, Japan
81-462-65-2324
feninfo@molex.com

Far East South Headquarters
Jurong, Singapore
65-6-268-6868
fesinfo@molex.com

European Headquarters
Munich, Germany
49-89-413092-0
eurinfo@molex.com

Corporate Headquarters
2222 Wellington Ct.
Lisle, IL 60532 U.S.A.
630-969-4550
Fax: 630-969-1352

Visit our Web site at <http://www.molex.com>