

Intel® Desktop Board D201GLY Technical Product Specification

May 2007

Order Number: D88126-001US

The Intel® Desktop Board D201GLY may contain design defects or errors known as errata that may cause the product to deviate from published specifications. Current characterized errata are documented in the Intel Desktop Board D201GLY Specification Update.

Revision History

Revision	Revision History	Date
-001	First release of the Intel® Desktop Board D201GLY Technical Product Specification	May 2007

This product specification applies to only standard Intel Desktop Board D201GLY with BIOS identifier LY66210M.86A.

Changes to this specification will be published in the Intel Desktop Board D201GLY Specification Update before being incorporated into a revision of this document.

INFORMATION IN THIS DOCUMENT IS PROVIDED IN CONNECTION WITH INTEL® PRODUCTS. NO LICENSE, EXPRESS OR IMPLIED, BY ESTOPPEL OR OTHERWISE, TO ANY INTELLECTUAL PROPERTY RIGHTS IS GRANTED BY THIS DOCUMENT. EXCEPT AS PROVIDED IN INTEL'S TERMS AND CONDITIONS OF SALE FOR SUCH PRODUCTS, INTEL ASSUMES NO LIABILITY WHATSOEVER, AND INTEL DISCLAIMS ANY EXPRESS OR IMPLIED WARRANTY, RELATING TO SALE AND/OR USE OF INTEL PRODUCTS INCLUDING LIABILITY OR WARRANTIES RELATING TO FITNESS FOR A PARTICULAR PURPOSE, MERCHANTABILITY, OR INFRINGEMENT OF ANY PATENT, COPYRIGHT OR OTHER INTELLECTUAL PROPERTY RIGHT. INTEL PRODUCTS ARE NOT INTENDED FOR USE IN MEDICAL, LIFE SAVING, OR LIFE SUSTAINING APPLICATIONS.

Intel Corporation may have patents or pending patent applications, trademarks, copyrights, or other intellectual property rights that relate to the presented subject matter. The furnishing of documents and other materials and information does not provide any license, express or implied, by estoppel or otherwise, to any such patents, trademarks, copyrights, or other intellectual property rights.

Intel may make changes to specifications and product descriptions at any time, without notice.

Designers must not rely on the absence or characteristics of any features or instructions marked "reserved" or "undefined." Intel reserves these for future definition and shall have no responsibility whatsoever for conflicts or incompatibilities arising from future changes to them.

Intel® desktop boards may contain design defects or errors known as errata, which may cause the product to deviate from published specifications. Current characterized errata are available on request.

Contact your local Intel sales office or your distributor to obtain the latest specifications before placing your product order.

Copies of documents which have an ordering number and are referenced in this document, or other Intel literature, may be obtained from:

Intel Corporation
P.O. Box 5937
Denver, CO 80217-9808

or call in North America 1-800-548-4725, Europe 44-0-1793-431-155, France 44-0-1793-421-777, Germany 44-0-1793-421-333, other Countries 708-296-9333.

Intel, the Intel logo and Celeron are registered trademarks of Intel Corporation or its subsidiaries in the United States and other countries.

* Other names and brands may be claimed as the property of others.

Copyright © 2007, Intel Corporation. All rights reserved.

Preface

This Technical Product Specification (TPS) specifies the board layout, components, connectors, power and environmental requirements, and the BIOS for the Intel® Desktop Board D201GLY. It describes the standard product and available manufacturing options.

Intended Audience

The TPS is intended to provide detailed, technical information about the Desktop Board D201GLY and its components to the vendors, system integrators, and other engineers and technicians who need this level of information. It is specifically *not* intended for general audiences.

What This Document Contains

Chapter	Description
1	A description of the hardware used on the Desktop Board D201GLY
2	A map of the resources of the Desktop Board
3	The features supported by the BIOS Setup program
4	A description of the BIOS error messages and POST codes

Typographical Conventions

This section contains information about the conventions used in this specification. Not all of these symbols and abbreviations appear in all specifications of this type.

Notes, Cautions, and Warnings

NOTE

Notes call attention to important information.

INTEGRATOR'S NOTES

Integrator's notes are used to call attention to information that may be useful to system integrators.

CAUTION

Cautions are included to help you avoid damaging hardware or losing data.

WARNING

Warnings indicate conditions, which if not observed, can cause personal injury.

Other Common Notation

#	Used after a signal name to identify an active-low signal (such as USBP0#)
(NxnX)	When used in the description of a component, N indicates component type, xn are the relative coordinates of its location on the board, and X is the instance of the particular part at that general location. For example, J5J1 is a connector, located at 5J. It is the first connector in the 5J area.
GB	Gigabyte (1,073,741,824 bytes)
GB/sec	Gigabytes per second
KB	Kilobyte (1024 bytes)
Kbit	Kilobit (1024 bits)
kbits/sec	1000 bits per second
MB	Megabyte (1,048,576 bytes)
MB/sec	Megabytes per second
Mbit	Megabit (1,048,576 bits)
Mbit/sec	Megabits per second
xxh	An address or data value ending with a lowercase h indicates a hexadecimal value.
x.x V	Volts. Voltages are DC unless otherwise specified.
*	This symbol is used to indicate third-party brands and names that are the property of their respective owners.

Contents

1 Product Description

1.1	Overview.....	10
1.1.1	Feature Summary	10
1.1.2	Manufacturing Options	11
1.1.3	Board Layout	12
1.1.4	Block Diagram	14
1.2	Online Support.....	15
1.3	Processor	15
1.4	System Memory	16
1.5	Silicon Integrated Systems* Chipset	17
1.5.1	Graphics Subsystem	17
1.5.2	USB	17
1.5.3	IDE Support	18
1.5.4	Real-Time Clock, CMOS SRAM, and Battery	19
1.6	S-Video Output	23
1.7	Legacy I/O Controller	23
1.7.1	Serial Port	23
1.7.2	Parallel Port.....	24
1.7.3	Keyboard and Mouse Interface	24
1.8	Audio Subsystem.....	24
1.8.1	Audio Subsystem Software	24
1.8.2	Audio Connectors	25
1.9	LAN Subsystem.....	26
1.9.1	LAN Subsystem Software.....	26
1.10	Hardware Management Subsystem	27
1.10.1	Fan Monitoring	27
1.11	Power Management	27
1.11.1	ACPI	28
1.11.2	Hardware Support	30

2 Technical Reference

2.1	Memory Map.....	35
2.2	Connectors and Headers.....	36
2.2.1	Back Panel Connectors	37
2.2.2	Component-side Connectors and Headers	38
2.2.3	Front Panel USB Headers.....	43
2.3	Jumper Blocks.....	44
2.3.1	Front Panel Audio Header/Jumper Block.....	44
2.3.2	BIOS Setup Configuration Jumper Block	45
2.4	Mechanical Considerations	46
2.4.1	Form Factor.....	46

2.5	Electrical Considerations.....	47
2.5.1	DC Loading.....	47
2.5.2	Add-in Board Considerations.....	47
2.5.3	Fan Header Current Capability.....	48
2.5.4	Power Supply Considerations.....	48
2.6	Thermal Considerations.....	49
2.7	Reliability.....	51
2.8	Environmental.....	51
2.9	Regulatory Compliance.....	52
2.9.1	Safety Standards.....	52
2.9.2	European Union Declaration of Conformity Statement.....	53
2.9.3	Product Ecology Statements.....	55
2.9.4	EMC Regulations.....	59
2.9.5	Product Certification Markings (Board Level).....	61

3 Overview of BIOS Features

3.1	Introduction.....	63
3.2	BIOS Flash Memory Organization.....	64
3.3	Resource Configuration.....	64
3.3.1	PCI Autoconfiguration.....	64
3.3.2	PCI IDE Support.....	65
3.4	System Management BIOS (SMBIOS).....	65
3.5	Legacy USB Support.....	66
3.6	BIOS Updates.....	66
3.6.1	Language Support.....	67
3.6.2	Custom Splash Screen.....	67
3.7	Boot Options.....	67
3.7.1	CD-ROM Boot.....	67
3.7.2	Network Boot.....	67
3.7.3	Booting Without Attached Devices.....	67
3.7.4	Changing the Default Boot Device During POST.....	68
3.8	Adjusting Boot Speed.....	68
3.8.1	Peripheral Selection and Configuration.....	68
3.8.2	BIOS Boot Optimizations.....	69
3.9	BIOS Security Features.....	70

4 Error Messages

4.1	BIOS Front-panel Power LED Codes.....	71
4.2	BIOS Error Messages.....	71
4.3	Port 80h POST Codes.....	72

Figures

1.	Board Components	12
2.	Block Diagram	14
3.	Back Panel Audio Connectors	25
4.	LAN Connector LED Locations.....	26
5.	Location of the Standby Power Indicator LED.....	33
6.	Back Panel Connectors	37
7.	Component-side Connectors and Headers	38
8.	Connection Diagram for Front Panel Header	41
9.	Connection Diagram for Front Panel USB Headers	43
10.	Location of the Jumper Blocks	44
11.	Board Dimensions	46
12.	Localized High Temperature Zones.....	50

Tables

1.	Feature Summary.....	10
2.	Manufacturing Options	11
3.	Board Components Shown in Figure 1	13
4.	Supported Memory Configurations	16
5.	LAN Connector LED States	26
6.	Effects of Pressing the Power Switch	28
7.	Power States and Targeted System Power.....	29
8.	Wake-up Devices and Events	30
9.	System Memory Map	35
10.	Back Panel Connectors Shown in Figure 6	37
11.	Component-side Connectors and Headers Shown in Figure 7	39
12.	Front Panel Audio Header	39
13.	Chassis Fan Connector	39
14.	Main Power Connector.....	40
15.	ATX12V Power Connector	40
16.	Front Panel Header	41
17.	States for a One-Color Power LED.....	42
18.	States for a Two-Color Power LED.....	42
19.	Front Panel Audio Header/Jumper Block.....	45
20.	BIOS Setup Configuration Jumper Settings.....	45
21.	DC Loading Characteristics	47
22.	Fan Header Current Capability.....	48
23.	MTBF Values.....	51
24.	Environmental Specifications.....	51
25.	Safety Standards.....	52
26.	Lead-Free Board Markings	58
27.	EMC Regulations	59
28.	Product Certification Markings	61
29.	BIOS Setup Program Menu Bar.....	64
30.	BIOS Setup Program Function Keys.....	64
31.	Boot Device Menu Options	68

Intel Desktop Board D201GLY Technical Product Specification

32. Supervisor and User Password Functions..... 70
33. Front-panel Power LED Blink Codes 71
34. BIOS Error Messages 71
35. Port 80h POST Code Ranges..... 72
36. Port 80h POST Codes 73
37. Typical Port 80h POST Sequence..... 76

1 Product Description

What This Chapter Contains

- 1.1 Overview..... 10
- 1.2 Online Support..... 15
- 1.3 Processor 15
- 1.4 System Memory 16
- 1.5 Silicon Integrated Systems* Chipset 17
- 1.6 S-Video Output 23
- 1.7 Legacy I/O Controller..... 23
- 1.8 Audio Subsystem..... 24
- 1.9 LAN Subsystem..... 26
- 1.10 Hardware Management Subsystem 27
- 1.11 Power Management 27

1.1 Overview

1.1.1 Feature Summary

Table 1 summarizes the major features of the board.

Table 1. Feature Summary

Form Factor	Mini-ITX, compatible with microATX (6.75 inches by 6.75 inches [171.45 millimeters by 171.45 millimeters])
Processor	Support for the following: <ul style="list-style-type: none"> Soldered-down Intel® Celeron® processor with a 533 MHz system bus
Memory	<ul style="list-style-type: none"> One 240-pin DDR2 SDRAM Dual Inline Memory Module (DIMM) socket Support for DDR2 667 MHz, DDR2 533 MHz and DDR2 400 MHz DIMMs (DDR 667 MHz validated to run at 533 MHz only) Support for up to 1 GB of system memory
Chipset	<ul style="list-style-type: none"> SiS* SiS662 Northbridge SiS SiS964L Southbridge
Video	Integrated SiS Mirage* 1 graphic engine
Audio	ADI* AD1888 audio codec
Legacy I/O Control	Winbond* W83627DHG-B based Legacy I/O controller for hardware management, serial, parallel, and PS/2* ports
Peripheral Interfaces	<ul style="list-style-type: none"> Six USB 2.0 ports One serial port One parallel port One Parallel ATA IDE interface with UDMA 33, ATA-66/100/133 support PS/2 keyboard and mouse ports One S-Video output port (optional)
LAN Support	10/100 Mbps/sec LAN subsystem using Broadcom* LAN adapter device
BIOS	Intel® BIOS resident in the 4-Mbit SPI Flash device
Expansion Capabilities	<ul style="list-style-type: none"> One PCI* Conventional bus connector
Hardware Monitor Subsystem (controlled by Winbond W83627DHG-B I/O controller)	<ul style="list-style-type: none"> Voltage sense to detect out of range power supply voltages Thermal sense to detect out of range thermal values Two fan connectors One fan sense input used to monitor fan activity Fan speed control

1.1.3 Board Layout

Figure 1 shows the location of the major components.

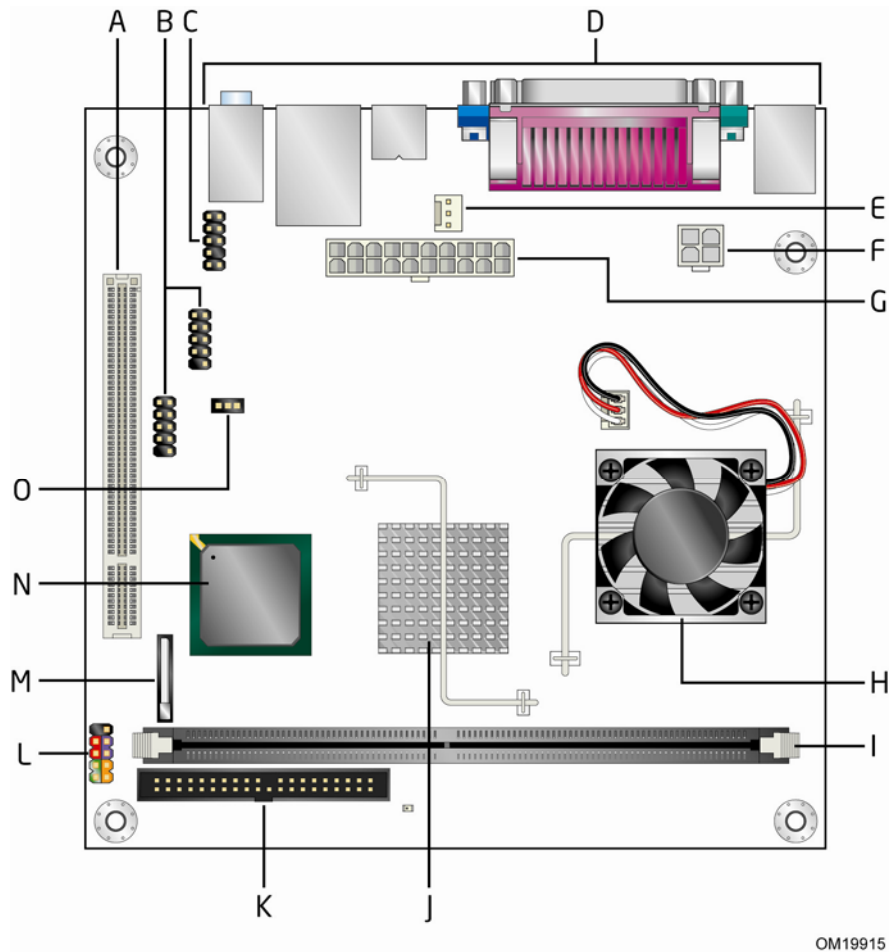

OM19915

Figure 1. Board Components

Table 3 lists the components identified in Figure 1.

Table 3. Board Components Shown in Figure 1

Item/callout from Figure 1	Description
A	PCI Conventional bus add-in card connector
B	Front panel USB headers
C	Front panel audio header
D	Back panel connectors
E	Chassis fan header
F	+12V power connector (ATX12V)
G	Main power connector
H	Intel Celeron processor
I	DIMM Channel A socket
J	SiS662 Northbridge
K	Parallel ATA IDE connector
L	Front panel I/O header
M	Battery
N	SiS964L Southbridge
O	BIOS Setup configuration jumper block

1.1.4 Block Diagram

Figure 2 is a block diagram of the major functional areas of the board.

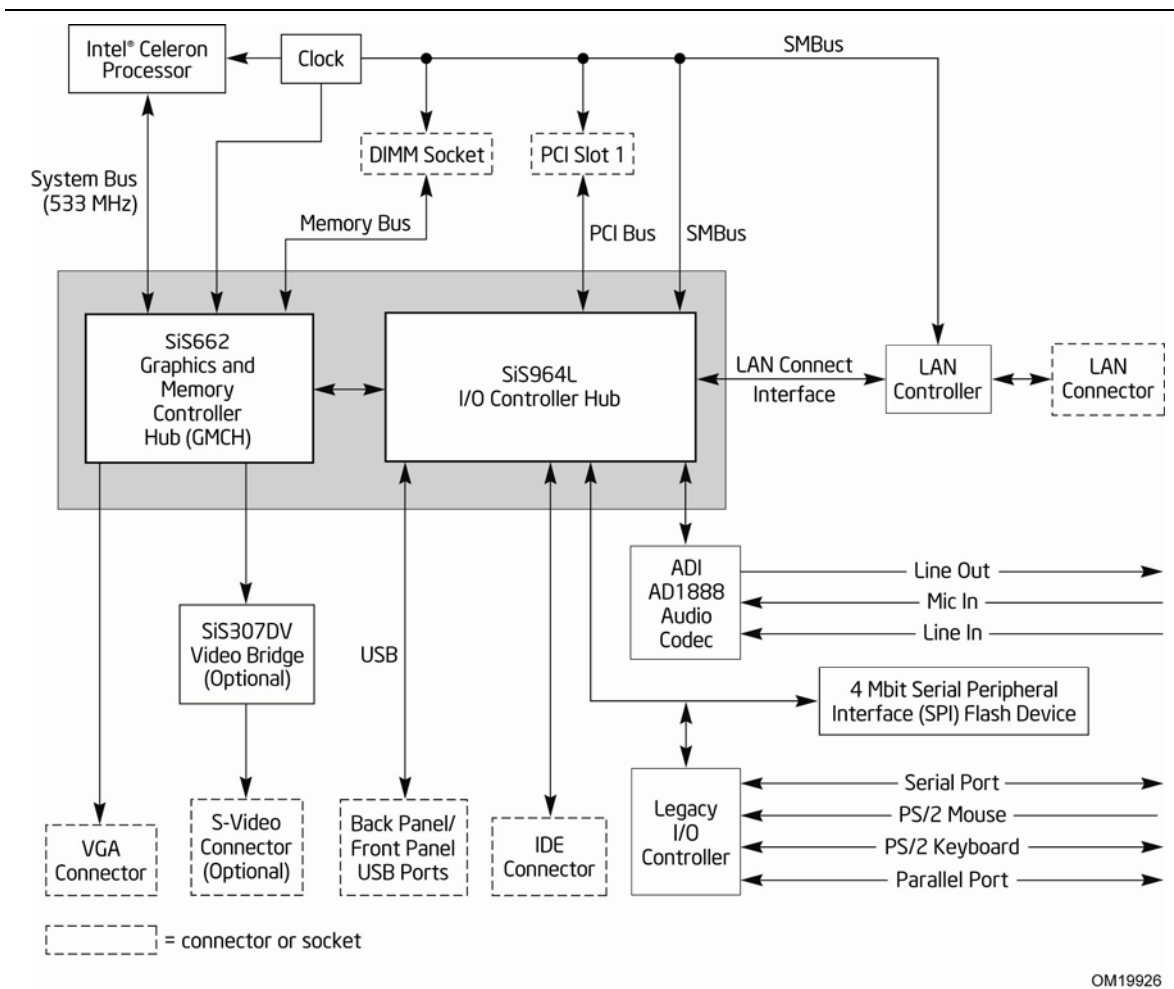

Figure 2. Block Diagram

1.2 Online Support

To find information about...	Visit this World Wide Web site:
Intel® Desktop Board D201GLY under "Desktop Board Products" or "Desktop Board Support"	http://www.intel.com/design/motherbd http://support.intel.com/support/motherboards/desktop
Available configurations for the Desktop Board D201GLY	http://developer.intel.com/design/motherbd/ly/ly_available.htm
Processor data sheets	http://www.intel.com/products/index.htm
Audio software and utilities	http://www.intel.com/design/motherbd
LAN software and drivers	http://www.intel.com/design/motherbd

1.3 Processor

The board is designed to support the Intel Celeron processor 200-series soldered down with a 533 MHz system bus.

For information about...	Refer to:
Supported processors for the D201GLY board	http://www.intel.com/go/findcpu

INTEGRATOR'S NOTE

Use only ATX12V-compliant power supplies.

For information about	Refer to
Power supply connectors	Section 2.2.2.1, page 40

1.4 System Memory

The board has one 240-pin DIMM socket and supports the following memory features:

- 1.8 V (only) DDR2 SDRAM DIMMs with gold-plated contacts
- Unbuffered, single-sided or double-sided DIMMs with the following restriction:
Double-sided DIMMs with x16 organization are not supported.
- 1 GB maximum total system memory
- Minimum total system memory: 128 MB
- Non-ECC DIMMs
- Serial Presence Detect
- DDR2 533 or DDR2 400 MHz SDRAM DIMMs

NOTE

To be fully compliant with all applicable DDR SDRAM memory specifications, the board should be populated with DIMMs that support the Serial Presence Detect (SPD) data structure. This allows the BIOS to read the SPD data and program the chipset to accurately configure memory settings for optimum performance. If non-SPD memory is installed, the BIOS will attempt to correctly configure the memory settings, but performance and reliability may be impacted or the DIMMs may not function under the determined frequency.

Table 4 lists the supported DIMM configurations.

Table 4. Supported Memory Configurations

DIMM Capacity	Configuration	SDRAM Density	SDRAM Organization Front-side/Back-side	Number of SDRAM Devices
128 MB	SS	256 Mbit	16 M x 16/empty	4
256 MB	SS	256 Mbit	32 M x 8/empty	8
256 MB	SS	512 Mbit	32 M x 16/empty	4
512 MB	DS	256 Mbit	32 M x 8/32 M x 8	16
512 MB	SS	512 Mbit	64 M x 8/empty	8
512 MB	SS	1 Gbit	64 M x 16/empty	4
1024 MB	DS	512 Mbit	64 M x 8/64 M x 8	16
1024 MB	SS	1 Gbit	128 M x 8/empty	8

Note: In the second column, "DS" refers to double-sided memory modules (containing two rows of SDRAM) and "SS" refers to single-sided memory modules (containing one row of SDRAM).

1.5 Silicon Integrated Systems* Chipset

The Silicon Integrated Systems chipset consists of the following devices:

- SiS662 Northbridge
- SiS964L Southbridge

The SiS662 Northbridge is a centralized controller for the system bus and the memory bus. The SiS662 Northbridge also provides integrated graphics capabilities supporting 3D, 2D, and display capabilities. The SiS964L Southbridge is a centralized controller for the board's I/O paths.

For information about	Refer to
The Silicon Integrated Systems SiS662 Northbridge	http://www.sis.com/
The Silicon Integrated Systems SiS964L Southbridge	http://www.sis.com/
Resources used by the chipset	Chapter 2

1.5.1 Graphics Subsystem

The board uses the integrated Mirage 1 graphic engine in the SiS662 Northbridge.

1.5.2 USB

The board supports up to six USB 2.0 ports, supports UHCI and EHCI, and uses UHCI- and EHCI-compatible drivers.

The SiS964L Southbridge provides the USB controller for all ports. The port arrangement is as follows:

- Two ports are implemented with dual stacked back panel connectors adjacent to the audio connectors
- Four ports are routed to two separate front panel USB headers

NOTE

Computer systems that have an unshielded cable attached to a USB port may not meet FCC Class B requirements, even if no device is attached to the cable. Use shielded cable that meets the requirements for full-speed devices.

For information about	Refer to
The location of the USB connectors on the back panel	Figure 6, page 37
The location of the front panel USB connectors	Figure 7, page 38

1.5.3 IDE Support

The board provides one parallel ATA IDE connector that supports two devices.

1.5.3.1 Parallel ATA IDE Interface

The D201GLY board has one bus-mastering Parallel ATA IDE interface. The Parallel ATA IDE interface supports the following modes:

- Programmed I/O (PIO): processor controls data transfer.
- 8237-style DMA: DMA offloads the processor, supporting transfer rates of up to 16 MB/sec.
- Ultra DMA: DMA protocol on IDE bus supporting host and target throttling and transfer rates of up to 33 MB/sec.
- ATA-66: DMA protocol on IDE bus supporting host and target throttling and transfer rates of up to 66 MB/sec. ATA-66 protocol is similar to Ultra DMA and is device driver compatible.
- ATA-100: DMA protocol on IDE bus allows host and target throttling. The SiS964L's ATA-100 logic can achieve read transfer rates up to 100 MB/sec and write transfer rates up to 88 MB/sec.

NOTE

ATA-66 and ATA-100 are faster timings and require a specialized cable to reduce reflections, noise, and inductive coupling.

The Parallel ATA IDE interface also supports ATAPI devices (such as CD-ROM drives) and ATA devices using the transfer modes.

For information about	Refer to
------------------------------	-----------------

The location of the Parallel ATA IDE connector	Figure 7, page 38
--	-------------------

1.5.4 Real-Time Clock, CMOS SRAM, and Battery

A coin-cell battery (CR2032) powers the real-time clock and CMOS memory. When the computer is not plugged into a wall socket, the battery has an estimated life of three years. When the computer is plugged in, the standby current from the power supply extends the life of the battery. The clock is accurate to ± 13 minutes/year at 25 °C with 3.3 VSB applied.

NOTE

If the battery and AC power fail, custom defaults, if previously saved, will be loaded into CMOS RAM at power-on.

When the voltage drops below a certain level, the BIOS Setup program settings stored in CMOS RAM (for example, the date and time) might not be accurate. Replace the battery with an equivalent one. Figure 1 on page 12 shows the location of the battery.



CAUTION

Risk of explosion if the battery is replaced with an incorrect type. Batteries should be recycled where possible. Disposal of used batteries must be in accordance with local environmental regulations.



PRECAUTION

Risque d'explosion si la pile usagée est remplacée par une pile de type incorrect. Les piles usagées doivent être recyclées dans la mesure du possible. La mise au rebut des piles usagées doit respecter les réglementations locales en vigueur en matière de protection de l'environnement.



FORHOLDSREGEL

Ekspløsningsfare, hvis batteriet erstattes med et batteri af en forkert type. Batterier bør om muligt genbruges. Bortskaffelse af brugte batterier bør foregå i overensstemmelse med gældende miljølovgivning.



OBS!

Det kan oppstå eksplosjonsfare hvis batteriet skiftes ut med feil type. Brukte batterier bør kastes i henhold til gjeldende miljølovgivning.



VIKTIGT!

Risk för explosion om batteriet ersätts med felaktig batterityp. Batterier ska kasseras enligt de lokala miljövårdsbestämmelserna.



VARO

Räjähdyksvaara, jos pariston tyyppi on väärä. Paristot on kierrätettävä, jos se on mahdollista. Käytetyt paristot on hävitettävä paikallisten ympäristömääräysten mukaisesti.



VORSICHT

Bei falschem Einsetzen einer neuen Batterie besteht Explosionsgefahr. Die Batterie darf nur durch denselben oder einen entsprechenden, vom Hersteller empfohlenen Batterietyp ersetzt werden. Entsorgen Sie verbrauchte Batterien den Anweisungen des Herstellers entsprechend.



AVVERTIMENTO

Esiste il pericolo di un esplosione se la pila non viene sostituita in modo corretto. Utilizzare solo pile uguali o di tipo equivalente a quelle consigliate dal produttore. Per disfarsi delle pile usate, seguire le istruzioni del produttore.



PRECAUCIÓN

Existe peligro de explosión si la pila no se cambia de forma adecuada. Utilice solamente pilas iguales o del mismo tipo que las recomendadas por el fabricante del equipo. Para deshacerse de las pilas usadas, siga igualmente las instrucciones del fabricante.



WAARSCHUWING

Er bestaat ontploffingsgevaar als de batterij wordt vervangen door een onjuist type batterij. Batterijen moeten zoveel mogelijk worden gerecycled. Houd u bij het weggoien van gebruikte batterijen aan de plaatselijke milieuwetgeving.



ATENÇÃO

Haverá risco de explosão se a bateria for substituída por um tipo de bateria incorreto. As baterias devem ser recicladas nos locais apropriados. A eliminação de baterias usadas deve ser feita de acordo com as regulamentações ambientais da região.



AŚCIAROŻZNAŚĆ

Існуе рызыка выбуху, калі заменены акумулятар неправільнага тыпу. Акумулятары павінны, па магчымасці, перепрацоўвацца. Пазбаўляцца ад старых акумулятараў патрэбна згодна з мясцовым заканадаўствам па экалогіі.



UPOZORNĚNÍ

V případě výměny baterie za nesprávný druh může dojít k výbuchu. Je-li to možné, baterie by měly být recyklovány. Baterie je třeba zlikvidovat v souladu s místními předpisy o životním prostředí.



Προσοχή

Υπάρχει κίνδυνος για έκρηξη σε περίπτωση που η μπαταρία αντικατασταθεί από μία λανθασμένου τύπου. Οι μπαταρίες θα πρέπει να ανακυκλώνονται όταν κάτι τέτοιο είναι δυνατό. Η απόρριψη των χρησιμοποιημένων μπαταριών πρέπει να γίνεται σύμφωνα με τους κατά τόπο περιβαλλοντικούς κανονισμούς.

**VIGYAZAT**

Ha a telepet nem a megfelelő típusú telepre cseréli, az felrobbanhat. A telepeket lehetőség szerint újra kell hasznosítani. A használt telepeket a helyi környezetvédelmi előírásoknak megfelelően kell kiselejtezni.

**注意**

異なる種類の電池を使用すると、爆発の危険があります。リサイクルが可能な地域であれば、電池をリサイクルしてください。使用後の電池を破棄する際には、地域の環境規制に従ってください。

**AWAS**

Risiko letupan wujud jika bateri digantikan dengan jenis yang tidak betul. Bateri sepatutnya dikitar semula jika boleh. Pelupusan bateri terpakai mestilah mematuhi peraturan alam sekitar tempatan.

**OSTRZEŻENIE**

Istnieje niebezpieczeństwo wybuchu w przypadku zastosowania niewłaściwego typu baterii. Zużyte baterie należy w miarę możliwości utylizować zgodnie z odpowiednimi przepisami ochrony środowiska.

**PRECAUȚIE**

Risc de explozie, dacă bateria este înlocuită cu un tip de baterie necorespunzător. Bateriile trebuie reciclate, dacă este posibil. Depozitarea bateriilor uzate trebuie să respecte reglementările locale privind protecția mediului.

**ВНИМАНИЕ**

При использовании батареи несоответствующего типа существует риск ее взрыва. Батареи должны быть утилизированы по возможности. Утилизация батарей должна проводиться по правилам, соответствующим местным требованиям.

**UPOZORNENIE**

Ak batériu vymeníte za nesprávny typ, hrozí nebezpečenstvo jej výbuchu. Batérie by sa mali podľa možnosti vždy recyklovať. Likvidácia použitých batérií sa musí vykonávať v súlade s miestnymi predpismi na ochranu životného prostredia.

**POZOR**

Zamenjava baterije z baterijo drugačnega tipa lahko povzroči eksplozijo. Če je mogoče, baterije reciklirajte. Rabljene baterije zavrzite v skladu z lokalnimi okoljevarstvenimi predpisi.

**คำเตือน**

ระวังการระเบิดที่เกิดจากเปลี่ยนแบตเตอรี่ผิดประเภท หากเป็นไปได้ ควรนำแบตเตอรี่ไปรีไซเคิล การทิ้งแบตเตอรี่ใช้แล้วต้องเป็นไปตามกฎข้อบังคับด้านสิ่งแวดล้อมของท้องถิ่น.



UYARI

Yanlış türde pil takıldığında patlama riski vardır. Piller mümkün olduğunda geri dönüştürülmelidir. Kullanılmış piller, yerel çevre yasalarına uygun olarak atılmalıdır.



ОСТОРОГА

Використовуйте батареї правильного типу, інакше існуватиме ризик вибуху. Якщо можливо, використані батареї слід утилізувати. Утилізація використаних батарей має бути виконана згідно місцевих норм, що регулюють охорону довкілля.



UPOZORNĚNÍ

V případě výměny baterie za nesprávný druh může dojít k výbuchu. Je-li to možné, baterie by měly být recyklovány. Baterie je třeba zlikvidovat v souladu s místními předpisy o životním prostředí.



ETTEVAATUST

Kui patarei asendatakse uue ebasobivat tüüpi patareiga, võib tekkida plahvatusoht. Tühjad patareid tuleb võimaluse korral viia vastavasse kogumispunkti. Tühjade patareide äraviskamisel tuleb järgida kohalikke keskkonnakaitse alaseid reegleid.



FIGYELMEZTETÉS

Ha az elemet nem a megfelelő típusúra cseréli, felrobbanhat. Az elemeket lehetőség szerint újra kell hasznosítani. A használt elemeket a helyi környezetvédelmi előírásoknak megfelelően kell kiselejtezni.



UZMANĪBU

Pastāv eksplozijas risks, ja baterijas tiek nomainītas ar nepareiza veida baterijām. Ja iespējams, baterijas vajadzētu nodot attiecīgos pieņemšanas punktus. Bateriju izmešanai atkritumos jānotiek saskaņā ar vietējiem vides aizsardzības noteikumiem.



DĒMESIO

Naudojant netinkamo tipo baterijas įrenginys gali sprogti. Kai tik įmanoma, baterijas reikia naudoti pakartotinai. Panaudotas baterijas išmesti būtina pagal vietinius aplinkos apsaugos nuostatus.



ATTENZJONI

Riskju ta' splużjoni jekk il-batterija tinbidel b'tip ta' batterija mhux korrett. Il-batteriji għandhom jiġu riċiklati fejn hu possibbli. Ir-rimi ta' batteriji użati għandu jsir skond ir-regolamenti ambjentali lokali.



OSTRZEŻENIE

Ryzyko wybuchu w przypadku wymiany na baterie niewłaściwego typu. W miarę możliwości baterie należy poddać recyklingowi. Zużytych baterii należy pozbywać się zgodnie z lokalnie obowiązującymi przepisami w zakresie ochrony środowiska.

1.6 S-Video Output

The D201GLY board supports S-Video output via 7 pin S-Video connector using SiS307DV supporting both 4 pin S-Video and Composite signal.

For information about

The Silicon Integrated Systems SiS307DV

Refer to

<http://www.sis.com/>

1.7 Legacy I/O Controller

The Winbond W83672DHG-B Legacy I/O controller provides the following features:

- One serial port
- One parallel port with Extended Capabilities Port (ECP) and Enhanced Parallel Port (EPP) support
- Serial IRQ interface compatible with serialized IRQ support for PCI Conventional bus systems
- PS/2-style mouse and keyboard interfaces
- Intelligent power management, including a programmable wake-up event interface
- PCI Conventional bus power management support

The BIOS Setup program provides configuration options for the I/O controller.

1.7.1 Serial Port

The serial port A connector is located on the back panel. The serial port supports data transfers at speeds up to 115.2 kbits/sec with BIOS support.

For information about

The location of the serial port A connector

Refer to

Figure 6, page 37

1.7.2 Parallel Port

The 25-pin D-Sub parallel port connector is located on the back panel. Use the BIOS Setup program to set the parallel port mode.

For information about	Refer to
The location of the parallel port connector	Figure 6, page 37

1.7.3 Keyboard and Mouse Interface

PS/2 keyboard and mouse connectors are located on the back panel.

⇒ NOTE

The keyboard is supported in the bottom PS/2 connector and the mouse is supported in the top PS/2 connector. Power to the computer should be turned off before a keyboard or mouse is connected or disconnected.

For information about	Refer to
The location of the keyboard and mouse connectors	Figure 6, page 37

1.8 Audio Subsystem

The audio subsystem consists of the following devices:

- SiS964L Southbridge
- ADI AD1888 audio codec

The audio subsystem includes these features:

- Signal-to-noise ratio ≥ 90 dB
- Supports wake events (driver dependent)
- Mic in pre-amp that supports dynamic, condenser, and electret microphones

The audio subsystem supports the following audio interfaces:

- Front panel audio header, including pins for:
 - Line out
 - Mic in
- Back panel audio connectors:
 - Line in
 - Line out
 - Mic in

1.8.1 Audio Subsystem Software

Audio software and drivers are available from Intel's World Wide Web site.

For information about	Refer to
Obtaining audio software and drivers	Section 1.1.4, page 14

1.8.2 Audio Connectors

The board contains audio connectors on the back panel and an audio header on the component side of the board. The front panel audio header is a 2 x 5-pin header that provides mic in and line out signals for front panel audio connectors.

The audio subsystem connectors are shown in Figure 3.

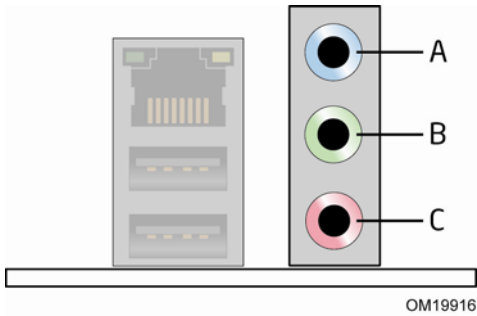

Item	Description
A	Line in
B	Line out
C	Mic in

Figure 3. Back Panel Audio Connectors

For information about	Refer to
The location of the front panel audio header	Figure 7, page 38
The signal names of the front panel audio header	Table 12, page 39

1.9 LAN Subsystem

The LAN subsystem consists of the following:

- Broadcom AC131KLMG LAN adapter device for 10/100 Mbits/sec Ethernet LAN connectivity
- RJ-45 LAN connector with integrated status LEDs
- Programmable transit threshold
- Configurable EEPROM that contains the MAC address

Two LEDs are built into the RJ-45 LAN connector (shown in Figure 4).

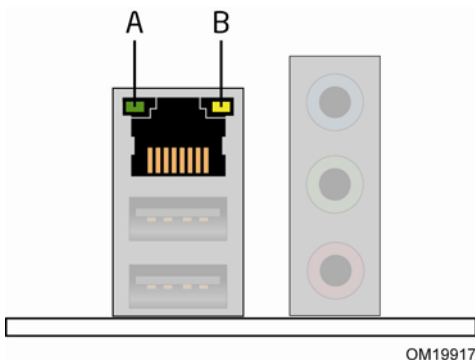

Figure 4. LAN Connector LED Locations

Table 5 describes the LED states when the board is powered up and the 10/100 Mbits/sec LAN subsystem is operating.

Table 5. LAN Connector LED States

LED Color	LED State	Condition
Green	Off	LAN link is not established.
	On	LAN link is established.
	Blinking	LAN activity is occurring.
Yellow	Off	10 Mbits/sec data rate is selected.
	On	100 Mbits/sec data rate is selected.

1.9.1 LAN Subsystem Software

LAN software and drivers are available from Intel’s World Wide Web site.

For information about

Refer to

Obtaining LAN software and drivers

Section 1.1.4, page 14

1.10 Hardware Management Subsystem

The hardware management features enable the board to be compatible with the Wired for Management (WfM) specification. The Winbond W83627DHG-B I/O controller is used to implement hardware monitoring and fan control. The features of this I/O controller include:

- Internal ambient temperature sensor
- Two remote thermal diode sensors for direct monitoring of processor temperature and ambient temperature sensing
- Power supply monitoring of four voltages (+5 V, +V_1P8__CORE, +VCCP, and +12 V) to detect levels above or below acceptable values
- Thermally monitored closed-loop fan control, for system fan, that can adjust the fan speed or switch the fans on or off as needed
- SMBus interface

1.10.1 Fan Monitoring

Fan monitoring can be implemented using Intel® Desktop Utilities, LANDesk* software, or third-party software.

For information about	Refer to
The functions of the fan connectors	Section 1.11.2.2, page 31

1.11 Power Management

Power management is implemented at several levels, including:

- Software support through Advanced Configuration and Power Interface (ACPI)
- Hardware support:
 - Power connector
 - Fan connectors
 - LAN wake capabilities
 - Instantly Available PC technology
 - Resume on Ring
 - Wake from USB
 - Wake from PS/2 devices
 - Power Management Event signal (PME#) wake-up support

1.11.1 ACPI

ACPI gives the operating system direct control over the power management and Plug and Play functions of a computer. The use of ACPI with this board requires an operating system that provides full ACPI support. ACPI features include:

- Plug and Play (including bus and device enumeration)
- Power management control of individual devices, add-in boards (some add-in boards may require an ACPI-aware driver), video displays, and hard disk drives
- Methods for achieving less than 15-watt system operation in the power-on/standby sleeping state
- A Soft-off feature that enables the operating system to power-off the computer
- Support for multiple wake-up events (see Table 8 on page 30)
- Support for a front panel power and sleep mode switch

Table 6 lists the system states based on how long the power switch is pressed, depending on how ACPI is configured with an ACPI-aware operating system.

Table 6. Effects of Pressing the Power Switch

If the system is in this state...	...and the power switch is pressed for	...the system enters this state
Off (ACPI G2/G5 – Soft off)	Less than four seconds	Power-on (ACPI G0 – working state)
On (ACPI G0 – working state)	Less than four seconds	Soft-off/Standby (ACPI G1 – sleeping state)
On (ACPI G0 – working state)	More than four seconds	Fail safe power-off (ACPI G2/G5 – Soft off)
Sleep (ACPI G1 – sleeping state)	Less than four seconds	Wake-up (ACPI G0 – working state)
Sleep (ACPI G1 – sleeping state)	More than four seconds	Power-off (ACPI G2/G5 – Soft off)

1.11.1.1 System States and Power States

Under ACPI, the operating system directs all system and device power state transitions. The operating system puts devices in and out of low-power states based on user preferences and knowledge of how devices are being used by applications. Devices that are not being used can be turned off. The operating system uses information from applications and user settings to put the system as a whole into a low-power state.

Table 7 lists the power states supported by the board along with the associated system power targets. See the ACPI specification for a complete description of the various system and power states.

Table 7. Power States and Targeted System Power

Global States	Sleeping States	Processor States	Device States	Targeted System Power (Note 1)
G0 – working state	S0 – working	C0 – working	D0 – working state.	Full power > 30 W
G1 – sleeping state	S1 – Processor stopped	C1 – stop grant	D1, D2, D3 – device specification specific.	5 W < power < 52.5 W
G1 – sleeping state	S4 – Suspend to disk. Context saved to disk.	No power	D3 – no power except for wake-up logic.	Power < 5 W (Note 2)
G2/S5	S5 – Soft off. Context not saved. Cold boot is required.	No power	D3 – no power except for wake-up logic.	Power < 5 W (Note 2)
G3 – mechanical off AC power is disconnected from the computer.	No power to the system.	No power	D3 – no power for wake-up logic, except when provided by battery or external source.	No power to the system. Service can be performed safely.

Notes:

1. Total system power is dependent on the system configuration, including add-in boards and peripherals powered by the system chassis' power supply.
2. Dependent on the standby power consumption of wake-up devices used in the system.

1.11.1.2 Wake-up Devices and Events

Table 8 lists the devices or specific events that can wake the computer from specific states.

Table 8. Wake-up Devices and Events

These devices/events can wake up the computer...	...from this state
LAN	S1, S4, S5 (Note)
Modem (back panel Serial Port A)	S1
PME# signal	S1, S4, S5 (Note)
Power switch	S1, S4, S5
PS/2 devices	S1
RTC alarm	S1, S4, S5
USB	S1

Note: For LAN and PME# signal, S5 is disabled by default in the BIOS Setup program. Setting this option to Power On will enable a wake-up event from LAN in the S5 state.

NOTE

The use of these wake-up events from an ACPI state requires an operating system that provides full ACPI support. In addition, software, drivers, and peripherals must fully support ACPI wake events.

1.11.2 Hardware Support

CAUTION

Ensure that the power supply provides adequate +5 V standby current if LAN wake capabilities and Instantly Available PC technology features are used. Failure to do so can damage the power supply. The total amount of standby current required depends on the wake devices supported and manufacturing options.

The board provides several power management hardware features, including:

- Power connector
- Fan headers
- LAN wake capabilities
- Instantly Available PC technology
- Resume on Ring
- Wake from USB
- Wake from PS/2 keyboard
- PME# signal wake-up support
- WAKE# signal wake-up support

LAN wake capabilities and Instantly Available PC technology require power from the +5 V standby line.

Resume on Ring enables telephony devices to access the computer when it is in a power-managed state. The method used depends on the type of telephony device (external or internal).

NOTE

The use of Resume on Ring and Wake from USB technologies from an ACPI state requires an operating system that provides full ACPI support.

1.11.2.1 Power Connector

ATX12V-compliant power supplies can turn off the system power through system control. When an ACPI-enabled system receives the correct command, the power supply removes all non-standby voltages.

When resuming from an AC power failure, the computer returns to the power state it was in before power was interrupted (on or off). The computer's response can be set using the Last Power State feature in the BIOS Setup program's Boot menu.

For information about	Refer to
The location of the main power connector	Figure 7, page 38
The signal names of the main power connector	Table 14, page 40

1.11.2.2 Fan Headers

The function/operation of the fan headers is as follows:

- The fans are on when the board is in the S0 or S1 state.
- The fans are off when the board is off or in the S4 or S5 state.
- System fan header is wired to a fan tachometer input of the Winbond W83627DHG-B I/O controller.
- All fan headers have a +12 V DC connection.

For information about	Refer to
The signal names of the chassis fan headers	Table 13, page 39

1.11.2.3 LAN Wake Capabilities



CAUTION

For LAN wake capabilities, the +5 V standby line for the power supply must be capable of providing adequate +5 V standby current. Failure to provide adequate standby current when implementing LAN wake capabilities can damage the power supply.

LAN wake capabilities enable remote wake-up of the computer through a network. The LAN network adapter monitors network traffic at the Media Independent Interface. Upon detecting a Magic Packet* frame, the LAN subsystem asserts a wake-up signal that powers up the computer. Depending on the LAN implementation, the board supports LAN wake capabilities with ACPI in the following ways:

- The PCI Conventional bus PME# signal for PCI 2.2 compliant LAN designs
- The onboard LAN subsystem

1.11.2.4 Resume on Ring

The operation of Resume on Ring can be summarized as follows:

- Resumes operation from ACPI S1 states
- Detects incoming call similarly for external and internal modems
- Requires modem interrupt be unmasked for correct operation

1.11.2.5 Wake from USB

USB bus activity wakes the computer from ACPI S1 states.

NOTE

Wake from USB requires the use of a USB peripheral that supports Wake from USB.

1.11.2.6 Wake from PS/2 Devices

PS/2 device activity wakes the computer from an ACPI S1 state.

1.11.2.7 PME# Signal Wake-up Support

When the PME# signal on the PCI Conventional bus is asserted, the computer wakes from an ACPI S1, S4, or S5 state (with Wake on PME enabled in BIOS).

1.11.2.8 +5 V Standby Power Indicator LED

The +5 V standby power indicator LED shows that power is still present even when the computer appears to be off. Figure 5 shows the location of the standby power indicator LED.



CAUTION

If AC power has been switched off and the standby power indicator is still lit, disconnect the power cord before installing or removing any devices connected to the board. Failure to do so could damage the board and any attached devices.

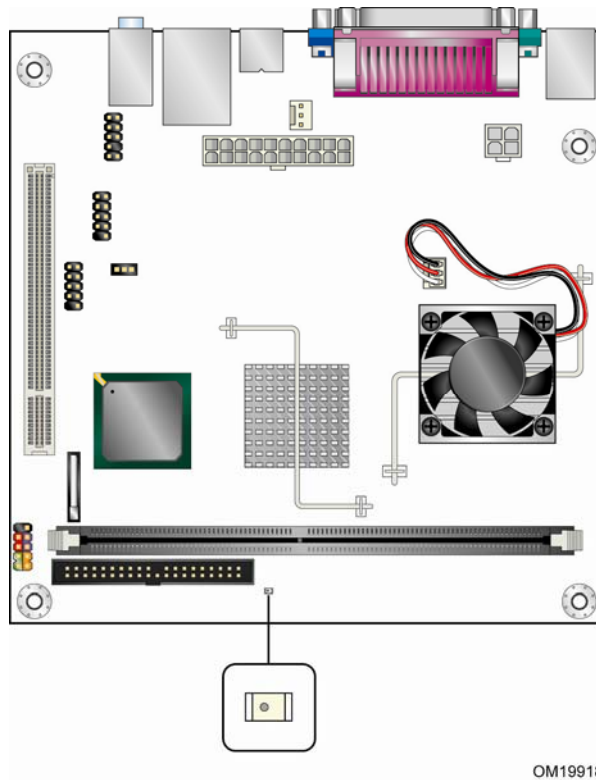

Figure 5. Location of the Standby Power Indicator LED

2 Technical Reference

What This Chapter Contains

2.1	Memory Map.....	35
2.2	Connectors and Headers.....	36
2.3	Jumper Blocks.....	44
2.4	Mechanical Considerations	46
2.5	Electrical Considerations.....	47
2.6	Thermal Considerations.....	49
2.7	Reliability	51
2.8	Environmental	51
2.9	Regulatory Compliance.....	52

2.1 Memory Map

Table 9 lists the system memory map.

Table 9. System Memory Map

Address Range (decimal)	Address Range (hex)	Size	Description
1024 K - 1048576 K	100000 - FFFFFFFF	4095 MB	Extended memory
960 K - 1024 K	F0000 - FFFFF	64 KB	Runtime BIOS
896 K - 960 K	E8000 - EFFFF	32 KB	Reserved
800 K - 896 K	C8000 - E7FFF	128 KB	Potential available high DOS memory (open to the PCI Conventional bus). Dependent on video adapter used.
640 K - 800 K	A0000 - C7FFF	160 KB	Video memory and BIOS
639 K - 640 K	9FC00 - 9FFFF	1 KB	Extended BIOS data (movable by memory manager software)
512 K - 639 K	80000 - 9FBFF	127 KB	Extended conventional memory
0 K - 512 K	00000 - 7FFFF	512 KB	Conventional memory

2.2 Connectors and Headers



CAUTION

Only the following connectors/headers have overcurrent protection: back panel USB, front panel USB, and PS/2.

The other internal connectors/headers are not overcurrent protected and should connect only to devices inside the computer's chassis, such as fans and internal peripherals. Do not use these connectors/headers to power devices external to the computer's chassis. A fault in the load presented by the external devices could cause damage to the computer, the power cable, and the external devices themselves.

This section describes the board's connectors and headers. The connectors and headers can be divided into these groups:

- Back panel I/O connectors (see page 37)
- Component-side I/O connectors and headers (see page 38)

2.2.1 Back Panel Connectors

Figure 6 shows the location of the back panel connectors. The back panel connectors are color-coded. The figure legend (Table 10) lists the colors used (when applicable).

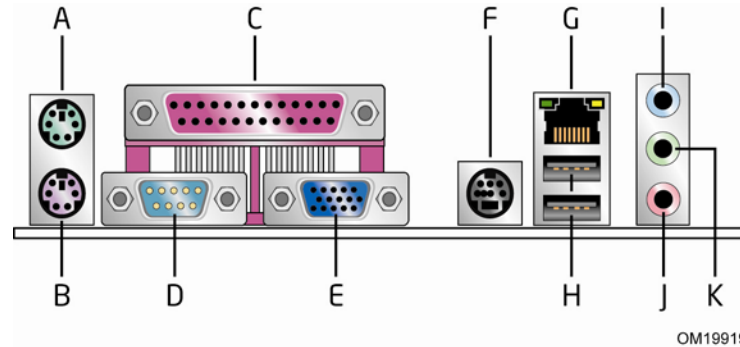

Figure 6. Back Panel Connectors

Table 10. Back Panel Connectors Shown in Figure 6

Item/callout from Figure 6	Description
A	PS/2 mouse port (Green)
B	PS/2 keyboard port (Purple)
C	Parallel port (Burgundy)
D	Serial port A (Teal)
E	VGA port
F	S-Video output (optional)
G	LAN
H	USB ports [2]
I	Line in
J	Mic in
K	Line out

NOTE

The back panel audio line out connector is designed to power headphones or amplified speakers only. Poor audio quality occurs if passive (non-amplified) speakers are connected to this output.

2.2.2 Component-side Connectors and Headers

Figure 7 shows the locations of the component-side connectors and headers.

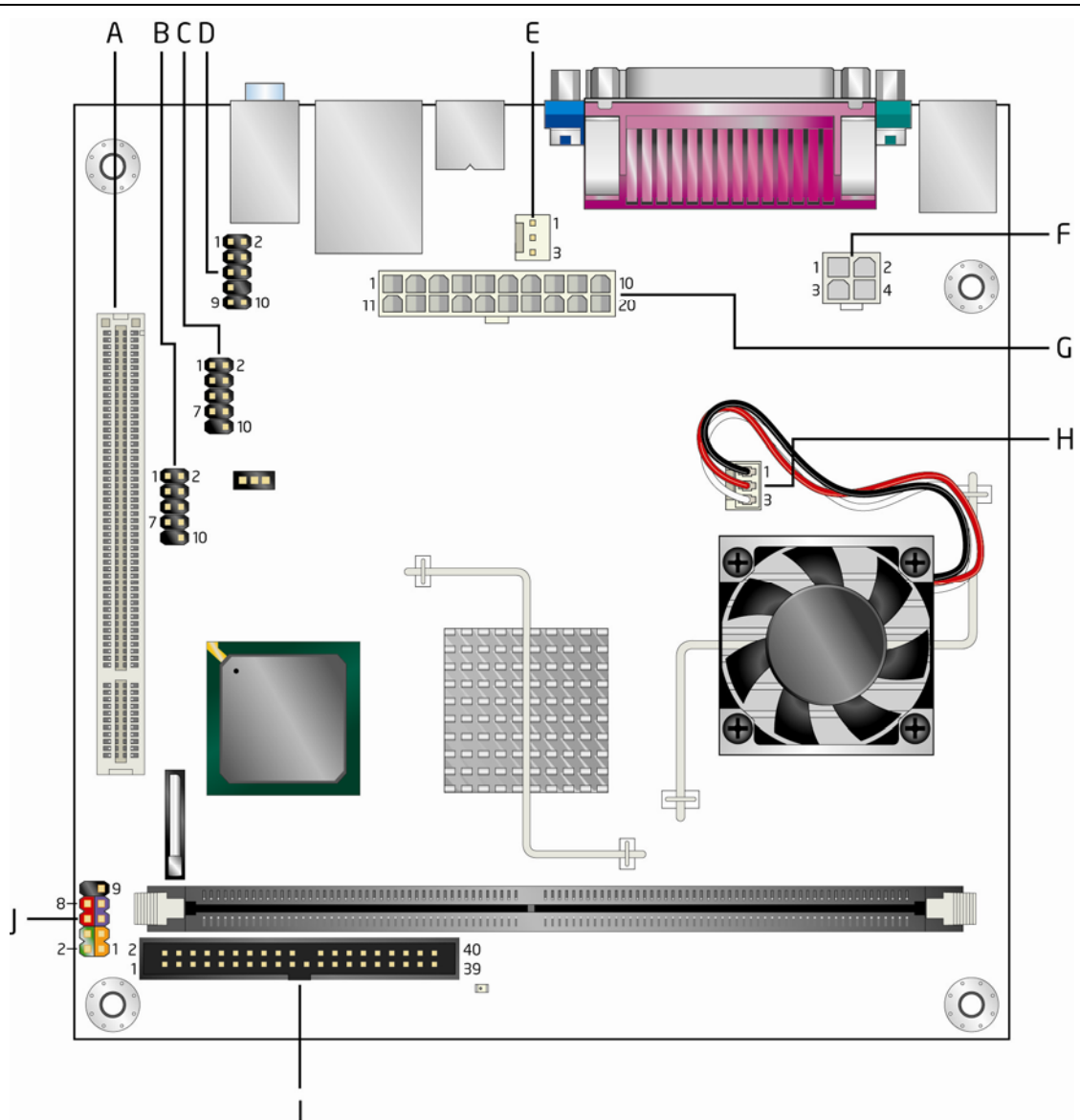

OM19920

Figure 7. Component-side Connectors and Headers

Table 11 lists the component-side connectors and headers identified in Figure 7.

Table 11. Component-side Connectors and Headers Shown in Figure 7

Item/callout from Figure 7	Description
A	PCI Conventional bus add-in card connector
B	Front panel USB header
C	Front panel USB header
D	Front panel audio header
E	Chassis fan header
F	+12V power connector (ATX12V)
G	Main power connector
H	Processor fan header
I	Parallel ATA IDE connector
J	Front panel header

Table 12. Front Panel Audio Header

Pin	Signal Name	Pin	Signal Name
1	MIC	2	Ground
3	MIC BIAS	4	Ground
5	FP_OUT_R	6	FP_RETURN_R
7	+5 V	8	Key
9	FP_OUT_L	10	FP_RETURN_L

 **INTEGRATOR'S NOTE**

The front panel audio connector is alternately used as a jumper block for routing audio signals. Refer to Section 2.3 on page 44 for more information.

Table 13. Chassis Fan Connector

Pin	Signal Name
1	Control
2	+12 V
3	Tach

2.2.2.1 Power Supply Connectors

The board has the following power supply connectors:

- **Main power** – a 2 x 10 connector. The board supports the use of ATX12V power supplies with 2 x 10 or 2 x 12 main power cables.
- **ATX12V power** – a 2 x 2 connector. This connector provides power directly to the processor voltage regulator and must always be used. Failure to do so will prevent the board from booting.

Table 14. Main Power Connector

Pin	Signal Name	Pin	Signal Name
1	+3.3 V	11	+3.3 V
2	+3.3 V	12	-12 V
3	Ground	13	Ground
4	+5 V	14	PS-ON# (power supply remote on/off)
5	Ground	15	Ground
6	+5 V	16	Ground
7	Ground	17	Ground
8	PWRGD (Power Good)	18	+5 V
9	+5 V (Standby)	19	+5 V
10	+12 V	20	+5 V

Table 15. ATX12V Power Connector

Pin	Signal Name	Pin	Signal Name
1	Ground	2	Ground
3	+12 V	4	+12 V

2.2.2.2 Add-in Card Connectors

The board has one PCI Conventional (rev 2.3 compliant) bus add-in card connector. PCI Conventional bus add-in cards with SMBus support can access sensor data and other information residing on the board.

Note the following considerations for the PCI Conventional bus connector:

- The PCI Conventional bus connector is bus master capable.
- SMBus signals are routed to the PCI Conventional bus connector. This enables PCI Conventional bus add-in boards with SMBus support to access sensor data on the board. The specific SMBus signals are as follows:
 - The SMBus clock line is connected to pin A40.
 - The SMBus data line is connected to pin A41.

2.2.2.3 Front Panel Header

This section describes the functions of the front panel header. Table 16 lists the signal names of the front panel header. Figure 8 is a connection diagram for the front panel header.

Table 16. Front Panel Header

Pin	Signal	In/Out	Description	Pin	Signal	In/Out	Description
Hard Drive Activity LED [Orange]				Power LED [Green]			
1	HD_PWR	Out	Hard disk LED pull-up to +5 V	2	HDR_BLNK_GRN	Out	Front panel green LED
3	HAD#	Out	Hard disk active LED	4	HDR_BLNK_YEL	Out	Front panel yellow LED
Reset Switch [Blue]				On/Off Switch [Red]			
5	Ground		Ground	6	FPBUT_IN	In	Power switch
7	FP_RESET#	In	Reset switch	8	Ground		Ground
Power				Not Connected			
9	+5 V		Power	10	N/C		Not connected

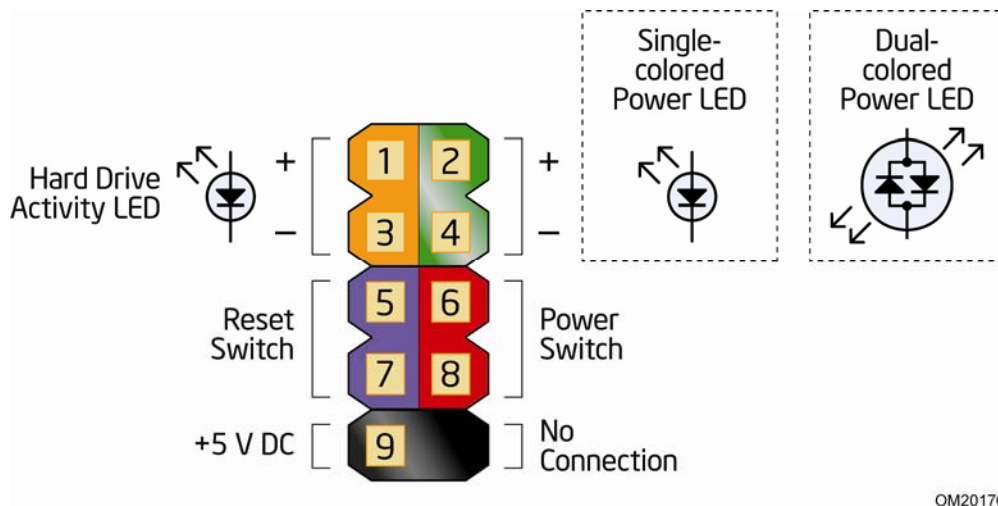

OM20176

Figure 8. Connection Diagram for Front Panel Header

2.2.2.3.1 Hard Drive Activity LED Header [Orange]

Pins 1 and 3 [Orange] can be connected to an LED to provide a visual indicator that data is being read from or written to a hard drive. Proper LED function requires an IDE hard drive connected to an onboard IDE connector.

2.2.2.3.2 Reset Switch Header [Blue]

Pins 5 and 7 [Blue] can be connected to a momentary single pole, single throw (SPST) type switch that is normally open. When the switch is closed, the board resets and runs the POST.

2.2.2.3.3 Power/Sleep LED Header [Green]

Pins 2 and 4 [Green] can be connected to a one- or two-color LED. Table 17 shows the possible states for a one-color LED. Table 18 shows the possible states for a two-color LED.

Table 17. States for a One-Color Power LED

LED State	Description
Off	Power off/sleeping
Steady Green	Running

Table 18. States for a Two-Color Power LED

LED State	Description
Off	Power off
Steady Green	Running
Steady Yellow	Sleeping

 **NOTE**

The colors listed in Table 17 and Table 18 are suggested colors only. Actual LED colors are product- or customer-specific.

2.2.2.3.4 Power Switch Header [Red]

Pins 6 and 8 [Red] can be connected to a front panel momentary-contact power switch. The switch must pull the SW_ON# pin to ground for at least 50 ms to signal the power supply to switch on or off. (The time requirement is due to internal debounce circuitry on the board.) At least two seconds must pass before the power supply will recognize another on/off signal.

2.2.3 Front Panel USB Headers

Figure 9 is a connection diagram for the front panel USB headers.

✂ INTEGRATOR'S NOTES

- The +5 V DC power on the USB connector is fused.
- Pins 1, 3, 5, and 7 comprise one USB port.
- Pins 2, 4, 6, and 8 comprise one USB port.
- Use only a front panel USB connector that conforms to the USB 2.0 specification for high-speed USB devices.

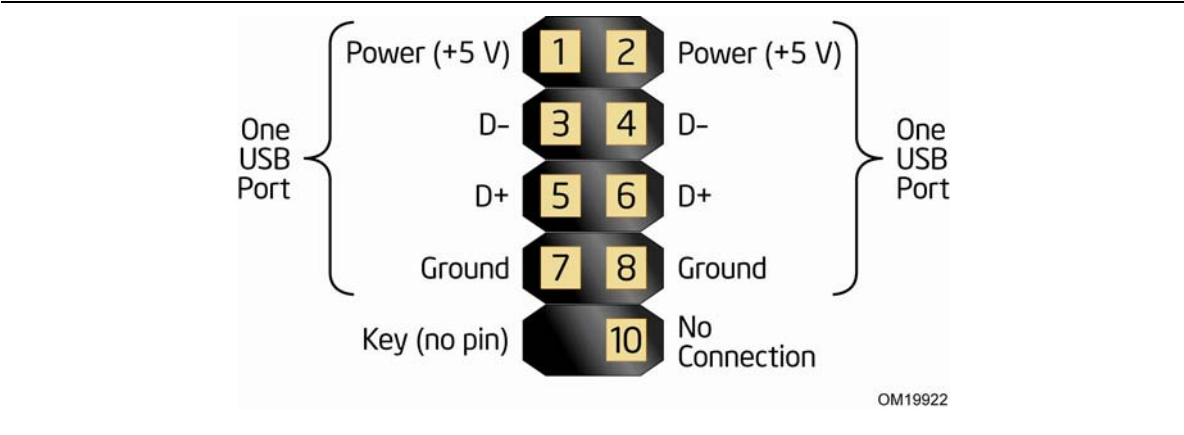

Figure 9. Connection Diagram for Front Panel USB Headers

2.3 Jumper Blocks

CAUTION

Do not move any jumpers with the power on. Always turn off the power and unplug the power cord from the computer before changing a jumper setting. Otherwise, the Desktop Board could be damaged.

Figure 10 shows the location of the jumper blocks.

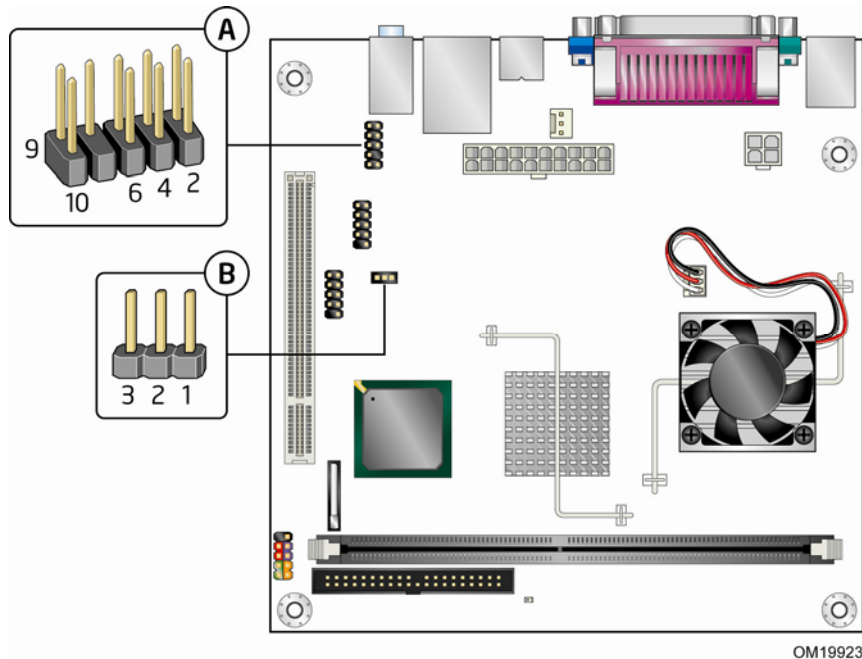

Item	Description
A	Front panel audio header/jumper block
B	BIOS Setup configuration jumper block

Figure 10. Location of the Jumper Blocks

2.3.1 Front Panel Audio Header/Jumper Block

This connector has two functions:

- With jumpers installed, the audio line out and mic in signals are routed to the back panel audio connectors.
- With jumpers removed, the connector provides audio line out and mic in signals for front panel audio headers.

Table 19 describes the two configurations of this header/jumper block.



CAUTION

Do not place jumpers on this block in any configuration other than the one described in Table 19. Other jumper configurations are not supported and could damage the Desktop Board.

Table 19. Front Panel Audio Header/Jumper Block

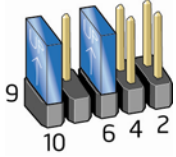
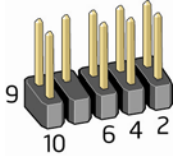
Jumper Setting	Configuration
 <p>5 and 6 9 and 10</p>	Audio line out and mic in signals are routed to the back panel audio connectors. The back panel audio connectors are shown in Figure 6 on page 37.
 <p>No jumpers installed</p>	Table 12 on page 39 lists the names of the signals available on this connector when no jumpers are installed.





INTEGRATOR'S NOTE

When the jumpers are removed and this connector is used for front panel audio, the back panel audio line out and mic in connectors are disabled.

2.3.2 BIOS Setup Configuration Jumper Block

This 3-pin jumper block determines the BIOS Setup program's mode. Table 20 describes the jumper settings for the three modes: normal, configure, and recovery. When the jumper is set to configuration mode and the computer is powered-up, the BIOS compares the processor version and the microcode version in the BIOS and reports if the two match.

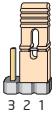
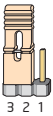
Table 20. BIOS Setup Configuration Jumper Settings

Function/Mode	Jumper Setting	Configuration
Normal	1-2 	The BIOS uses current configuration information and passwords for booting.
Configure	2-3 	After the POST runs, Setup runs automatically. The maintenance menu is displayed.
Recovery	None 	The BIOS attempts to recover the BIOS configuration. A recovery diskette is required.

2.4 Mechanical Considerations

2.4.1 Form Factor

The board is designed to fit into a microATX-form-factor chassis. Figure 11 illustrates the mechanical form factor of the board. Dimensions are given in inches [millimeters]. The outer dimensions are 6.75 inches by 6.75 inches [171.45 millimeters by 171.45 millimeters]. Location of the I/O connectors and mounting holes are in compliance with the micro-ATX specification.

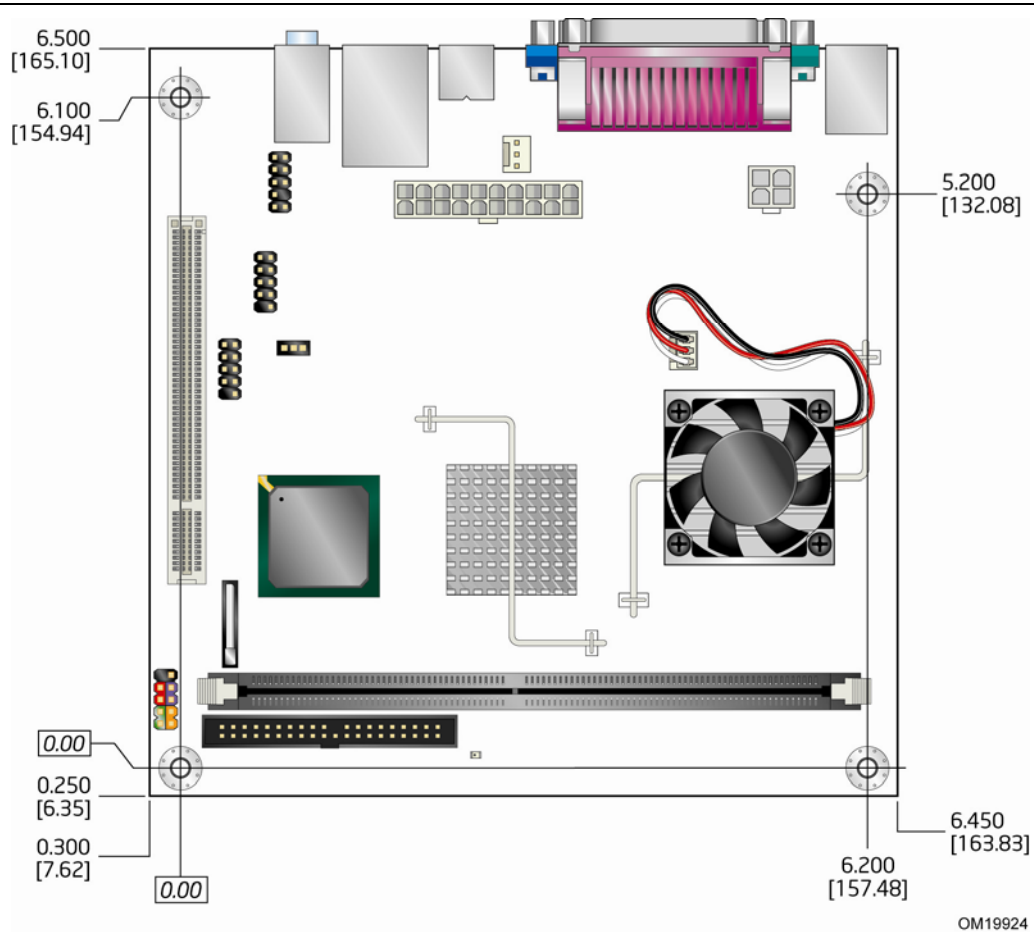

Figure 11. Board Dimensions

2.5 Electrical Considerations

2.5.1 DC Loading

Table 21 lists the DC loading characteristics of the board. This data is based on a DC analysis of all active components within the board that impact its power delivery subsystems. The analysis does not include PCI add-in cards. Minimum values assume a light load placed on the board that is similar to an environment with no applications running and no USB current draw. Maximum values assume a load placed on the board that is similar to a heavy gaming environment with a 500 mA current draw per USB port. These calculations are not based on specific processor values or memory configurations but are based on the minimum and maximum current draw possible from the board’s power delivery subsystems to the processor, memory, and USB ports.

Use the datasheets for add-in cards, such as PCI, to determine the overall system power requirements. The selection of a power supply at the system level is dependent on the system’s usage model and not necessarily tied to a particular processor speed.

Table 21. DC Loading Characteristics

Mode	DC Power	DC Current at:				
		+3.3 V	+5 V	+12 V	-12 V	+5 VSB
Minimum loading	45 W	2.0 A	1.8 A	2.19 A	0 A	0.25 A
Maximum loading	175 W	4.42 A	17.88 A	5.15 A	0.1 A	1.19 A

2.5.2 Add-in Board Considerations

The board is designed to provide 2 A (average) of +5 V current for one add-in board.

2.5.3 Fan Header Current Capability



CAUTION

The processor fan must be connected to the processor fan header, not to a chassis fan header. Connecting the processor fan to a chassis fan header may result in onboard component damage that will halt fan operation.

Table 22 lists the current capability of the fan headers.

Table 22. Fan Header Current Capability

Fan Header	Maximum Available Current
Processor fan	2 A
Rear chassis fan	1.5 A

2.5.4 Power Supply Considerations



CAUTION

The +5 V standby line for the power supply must be capable of providing adequate +5 V standby current. Failure to do so can damage the power supply. The total amount of standby current required depends on the wake devices supported and manufacturing options.

System integrators should refer to the power usage values listed in Table 21 when selecting a power supply for use with the board.

Additional power required will depend on configurations chosen by the integrator.

The power supply must comply with the following recommendations found in the indicated sections of the ATX form factor specification.

- The potential relation between 3.3 VDC and +5 VDC power rails
- The current capability of the +5 VSB line
- All timing parameters
- All voltage tolerances

2.6 Thermal Considerations



CAUTION

Failure to ensure appropriate airflow may result in reduced performance of both the processor and/or voltage regulator or, in some instances, damage to the board. For a list of chassis that have been tested with Intel desktop boards please refer to the following website:

<http://developer.intel.com/design/motherbd/cooling.htm>

All responsibility for determining the adequacy of any thermal or system design remains solely with the reader. Intel makes no warranties or representations that merely following the instructions presented in this document will result in a system with adequate thermal performance.



CAUTION

Ensure that the ambient temperature does not exceed the board's maximum operating temperature. Failure to do so could cause components to exceed their maximum case temperature and malfunction. For information about the maximum operating temperature, see the environmental specifications in Section 2.8.



CAUTION

Ensure that proper airflow is maintained in the processor voltage regulator circuit. Failure to do so may result in damage to the voltage regulator circuit. The processor voltage regulator area (item A in Figure 12) can reach a temperature of up to 85 °C in an open chassis.

Figure 12 shows the locations of the localized high temperature zones.

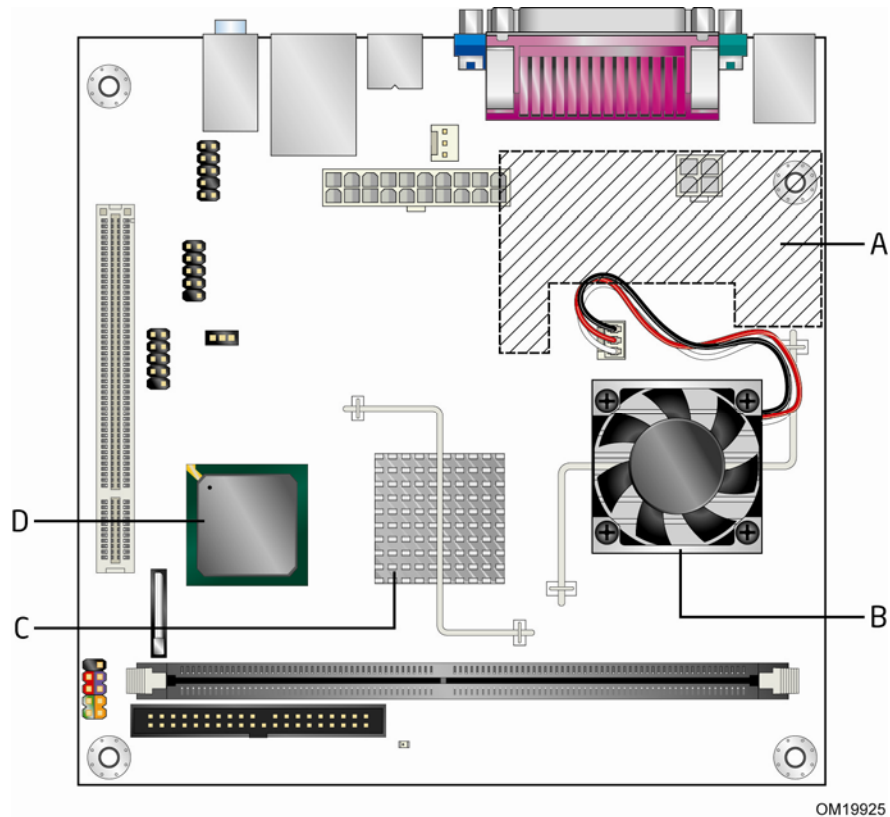

Item	Description
A	Processor voltage regulator area
B	Processor
C	SiS662 Northbridge
D	SiS964L Southbridge

Figure 12. Localized High Temperature Zones

The operating temperature, current load, or operating frequency could affect case temperatures. Maximum case temperatures are important when considering proper airflow to cool the board. For processor case temperature, see processor datasheets and processor specification updates for supported processors. For chipset thermal information, refer to the following website:

<http://www.sis.com>

2.7 Reliability

The Mean Time Between Failures (MTBF) prediction is calculated using component and subassembly random failure rates. The calculation is based on the Bellcore Reliability Prediction Procedure, TR-NWT-000332, Issue 4, September 1991. The MTBF prediction is used to estimate repair rates and spare parts requirements.

The MTBF data is calculated from predicted data at 55 °C. Table 23 shows the MTBF value for each of the D201GLY board’s manufacturing options:

Table 23. MTBF Values

Product Code	MTBF Value
LAD201GLYT	327175.8832 hours
LAD201GLY	327175.8832 hours
BOX/BLKD201GLYL	339835.5196 hours
LAD201GLYT1	327175.8832 hours
LAD201GLYL1	327175.8832 hours
BOX/BLKD201GLYL1	339835.5196 hours

2.8 Environmental

Table 24 lists the environmental specifications for the board.

Table 24. Environmental Specifications

Parameter	Specification
Temperature	
Non-Operating	-40 °C to +70 °C
Operating	0 °C to +55 °C
Shock	
Unpackaged	50 g trapezoidal waveform Velocity change of 170 inches/second
Packaged	Half sine 2 millisecond
	Product Weight (pounds) Free Fall (inches) Velocity Change (inches/sec ²)
	<20 36 167
	21-40 30 152
	41-80 24 136
	81-100 18 118
Vibration	
Unpackaged	5 Hz to 20 Hz: 0.01 g ² Hz sloping up to 0.02 g ² Hz 20 Hz to 500 Hz: 0.02 g ² Hz (flat)
Packaged	5 Hz to 40 Hz: 0.015 g ² Hz (flat) 40 Hz to 500 Hz: 0.015 g ² Hz sloping down to 0.00015 g ² Hz

2.9 Regulatory Compliance

This section contains the following regulatory compliance information for Desktop Board D201GLY:

- Safety standards
- European Union Declaration of Conformity statement
- Product Ecology statements
- Electromagnetic Compatibility (EMC) standards
- Product certification markings

2.9.1 Safety Standards

Desktop Board D201GLY complies with the safety standards stated in Table 25 when correctly installed in a compatible host system.

Table 25. Safety Standards

Standard	Title
UL 60950-1, First Edition	Information Technology Equipment – Safety - Part 1: General Requirements (USA and Canada)
EN 60950-1:2006, Second Edition	Information Technology Equipment – Safety - Part 1: General Requirements (European Union)
IEC 60950-1:2005, Second Edition	Information Technology Equipment – Safety - Part 1: General Requirements (International)

2.9.2 European Union Declaration of Conformity Statement

We, Intel Corporation, declare under our sole responsibility that the product Intel® Desktop Board D201GLY is in conformity with all applicable essential requirements necessary for CE marking, following the provisions of the European Council Directive 2004/108/EC(EMC Directive) and 2006/95/EC (Low Voltage Directive).

The product is properly CE marked demonstrating this conformity and is for distribution within all member states of the EU with no restrictions.



This product follows the provisions of the European Directives 2004/108/EC and 2006/95/EC.

Čeština Tento výrobek odpovídá požadavkům evropských směrnic 2004/108/EC a 2006/95/EC.

Dansk Dette produkt er i overensstemmelse med det europæiske direktiv 2004/108/EC & 2006/95/EC.

Dutch Dit product is in navolging van de bepalingen van Europees Directief 2004/108/EC & 2006/95/EC.

Eesti Antud toode vastab Euroopa direktiivides 2004/108/EC ja 2006/95/EC kehtestatud nõuetele.

Suomi Tämä tuote noudattaa EU-direktiivin 2004/108/EC & 2006/95/EC määräyksiä.

Français Ce produit est conforme aux exigences de la Directive Européenne 2004/108/EC & 2006/95/EC.

Deutsch Dieses Produkt entspricht den Bestimmungen der Europäischen Richtlinie 2004/108/EC & 2006/95/EC.

Ελληνικά Το παρόν προϊόν ακολουθεί τις διατάξεις των Ευρωπαϊκών Οδηγιών 2004/108/EC και 2006/95/EC.

Magyar E termék megfelel a 2004/108/EC és 2006/95/EC Európai Irányelv előírásainak.

Icelandic Þessi vara stenst reglugerð Evrópska Efnahags Bandalagsins númer 2004/108/EC & 2006/95/EC.

Italiano Questo prodotto è conforme alla Direttiva Europea 2004/108/EC & 2006/95/EC.

Latviešu Šis produkts atbilst Eiropas Direktīvu 2004/108/EC un 2006/95/EC noteikumiem.

Lietuvių Šis produktas atitinka Europos direktyvų 2004/108/EC ir 2006/95/EC nuostatas.

Intel Desktop Board D201GLY Technical Product Specification

Malti Dan il-prodott hu konformi mal-provvedimenti tad-Direttivi Ewropej 2004/108/EC u 2006/95/EC.

Norsk Dette produktet er i henhold til bestemmelsene i det europeiske direktivet 2004/108/EC & 2006/95/EC.

Polski Niniejszy produkt jest zgodny z postanowieniami Dyrektyw Unii Europejskiej 2004/108/EC i 73/23/EWG.

Portuguese Este produto cumpre com as normas da Diretiva Europeia 2004/108/EC & 2006/95/EC.

Español Este producto cumple con las normas del Directivo Europeo 2004/108/EC & 2006/95/EC.

Slovensky Tento produkt je v súlade s ustanoveniami európskych direktív 2004/108/EC a 2006/95/EC.

Slovenščina Izdelek je skladen z določbami evropskih direktiv 2004/108/EC in 2006/95/EC.

Svenska Denna produkt har tillverkats i enlighet med EG-direktiv 2004/108/EC & 2006/95/EC.

Türkçe Bu ürün, Avrupa Birliği'nin 2004/108/EC ve 2006/95/EC yönergelerine uyar.

2.9.3 Product Ecology Statements

The following information is provided to address worldwide product ecology concerns and regulations.

2.9.3.1 Disposal Considerations

This product contains the following materials that may be regulated upon disposal: lead solder on the printed wiring board assembly.

2.9.3.2 Recycling Considerations

As part of its commitment to environmental responsibility, Intel has implemented the Intel Product Recycling Program to allow retail consumers of Intel's branded products to return used products to selected locations for proper recycling.

Please consult the http://www.intel.com/intel/other/ehs/product_ecology for the details of this program, including the scope of covered products, available locations, shipping instructions, terms and conditions, etc.

中文

作为其对环境责任之承诺的部分，英特尔已实施 Intel Product Recycling Program（英特尔产品回收计划），以允许英特尔品牌产品的零售消费者将使用过的产品退还至指定地点作恰当的重复使用处理。

请参考http://www.intel.com/intel/other/ehs/product_ecology

Deutsch

Als Teil von Intels Engagement für den Umweltschutz hat das Unternehmen das Intel Produkt-Recyclingprogramm implementiert, das Einzelhandelskunden von Intel Markenprodukten ermöglicht, gebrauchte Produkte an ausgewählte Standorte für ordnungsgemäßes Recycling zurückzugeben.

Details zu diesem Programm, einschließlich der darin eingeschlossenen Produkte, verfügbaren Standorte, Versandanweisungen, Bedingungen usw., finden Sie auf der http://www.intel.com/intel/other/ehs/product_ecology

Español

Como parte de su compromiso de responsabilidad medioambiental, Intel ha implantado el programa de reciclaje de productos Intel, que permite que los consumidores al detalle de los productos Intel devuelvan los productos usados en los lugares seleccionados para su correspondiente reciclado.

Consulte la http://www.intel.com/intel/other/ehs/product_ecology para ver los detalles del programa, que incluye los productos que abarca, los lugares disponibles, instrucciones de envío, términos y condiciones, etc.

Français

Dans le cadre de son engagement pour la protection de l'environnement, Intel a mis en œuvre le programme Intel Product Recycling Program (Programme de recyclage des produits Intel) pour permettre aux consommateurs de produits Intel de recycler les produits usés en les retournant à des adresses spécifiées.

Visitez la page Web http://www.intel.com/intel/other/ehs/product_ecology pour en savoir plus sur ce programme, à savoir les produits concernés, les adresses disponibles, les instructions d'expédition, les conditions générales, etc.

日本語

インテルでは、環境保護活動の一環として、使い終わったインテルブランド製品を指定の場所へ返送していただき、リサイクルを適切に行えるよう、インテル製品リサイクルプログラムを発足させました。

対象製品、返送先、返送方法、ご利用規約など、このプログラムの詳細情報は、http://www.intel.com/intel/other/ehs/product_ecology (英語)をご覧ください。

Malay

Sebagai sebahagian daripada komitmennya terhadap tanggungjawab persekitaran, Intel telah melaksanakan Program Kitar Semula Produk untuk membenarkan pengguna-pengguna runcit produk jenama Intel memulangkan produk terguna ke lokasi-lokasi terpilih untuk dikitar semula dengan betul.

Sila rujuk http://www.intel.com/intel/other/ehs/product_ecology untuk mendapatkan butir-butir program ini, termasuklah skop produk yang dirangkumi, lokasi-lokasi tersedia, arahan penghantaran, terma & syarat, dsb.

Portuguese

Como parte deste compromisso com o respeito ao ambiente, a Intel implementou o Programa de Reciclagem de Produtos para que os consumidores finais possam enviar produtos Intel usados para locais selecionados, onde esses produtos são reciclados de maneira adequada.

Consulte o site http://www.intel.com/intel/other/ehs/product_ecology (em Inglês) para obter os detalhes sobre este programa, inclusive o escopo dos produtos cobertos, os locais disponíveis, as instruções de envio, os termos e condições, etc.

Russian

В качестве части своих обязательств к окружающей среде, в Intel создана программа утилизации продукции Intel (Product Recycling Program) для предоставления конечным пользователям марок продукции Intel возможности возврата используемой продукции в специализированные пункты для должной утилизации.

Пожалуйста, обратитесь на веб-сайт http://www.intel.com/intel/other/ehs/product_ecology за информацией об этой программе, принимаемых продуктах, местах приема, инструкциях об отправке, положениях и условиях и т.д.

Türkçe

Intel, çevre sorumluluğuna bağlılığının bir parçası olarak, perakende tüketicilerin Intel markalı kullanılmış ürünlerini belirlenmiş merkezlere iade edip uygun şekilde geri dönüştürmesini amaçlayan Intel Ürünleri Geri Dönüşüm Programı'nı uygulamaya koymuştur.

Bu programın ürün kapsamı, ürün iade merkezleri, nakliye talimatları, kayıtlar ve şartlar v.s dahil bütün ayrıntılarını öğrenmek için lütfen http://www.intel.com/intel/other/ehs/product_ecology

Web sayfasına gidin.

2.9.3.3 Lead Free Desktop Board



This Desktop Board is a European Union Restriction of Hazardous Substances (EU RoHS Directive 2002/95/EC) compliant product. EU RoHS restricts the use of six materials. One of the six restricted materials is lead.

This Desktop Board is lead free although certain discrete components used on the board contain a small amount of lead which is necessary for component performance and/or reliability. This Desktop Board is referred to as "Lead-free second level interconnect." The board substrate and the solder connections from the board to the components (second-level connections) are all lead free.

China bans the same substances and has the same limits as EU RoHS; however it requires different product marking and controlled substance information. The required mark shows the Environmental Friendly Usage Period (EFUP). The EFUP is defined as the number of years for which controlled listed substances will not leak or chemically deteriorate while in the product.

Table 26 shows the various forms of the “Lead-Free 2nd Level Interconnect” mark as it appears on the board and accompanying collateral.

Table 26. Lead-Free Board Markings

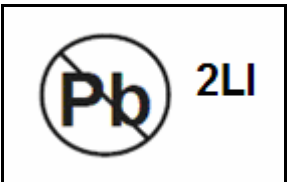
Description	Mark
<p>Lead-Free 2nd Level Interconnect: This symbol is used to identify electrical and electronic assemblies and components in which the lead (Pb) concentration level in the desktop board substrate and the solder connections from the board to the components (second-level interconnect) is not greater than 0.1% by weight (1000 ppm).</p>	<div style="border: 1px solid black; padding: 10px; text-align: center;">  <p>or</p> <div style="border: 1px solid black; padding: 10px; text-align: center;">  <p>or</p> <div style="border: 1px solid black; padding: 10px; text-align: center;">  </div> </div> </div>

2.9.4 EMC Regulations

Desktop Board D201GLY complies with the EMC regulations stated in Table 27 when correctly installed in a compatible host system.

Table 27. EMC Regulations

Regulation	Title
FCC 47 CFR Part 15, Subpart B	Title 47 of the Code of Federal Regulations, Part 15, Subpart B, Radio Frequency Devices. (USA)
ICES-003 Issue 4 (Class B)	Interference-Causing Equipment Standard, Digital Apparatus. (Canada)
EN55022: 2006 (Class B)	Limits and methods of measurement of Radio Interference Characteristics of Information Technology Equipment. (European Union)
EN55024:1998	Information Technology Equipment – Immunity Characteristics Limits and methods of measurement. (European Union)
EN55022:2006 (Class B)	Australian Communications Authority, Standard for Electromagnetic Compatibility. (Australia and New Zealand)
CISPR 22:2005 +A1:2005 +A2:2006 (Class B)	Limits and methods of measurement of Radio Disturbance Characteristics of Information Technology Equipment. (International)
CISPR 24: 1997 +A1:2001 +A2:2002	Information Technology Equipment – Immunity Characteristics – Limits and Methods of Measurement. (International)
VCCI V-3/2007.04, V-4/2007.04, Class B	Voluntary Control for Interference by Information Technology Equipment. (Japan)

Intel Desktop Board D201GLY Technical Product Specification

Japanese Kanji statement translation: this is a Class B product based on the standard of the Voluntary Control Council for Interference from Information Technology Equipment (VCCI). If this is used near a radio or television receiver in a domestic environment, it may cause radio interference. Install and use the equipment according to the instruction manual.

この装置は、情報処理装置等電波障害自主規制協議会（VCCI）の基準に基づくクラスB 情報技術装置です。この装置は、家庭環境で使用することを目的としていますが、この装置がラジオやテレビジョン受信機に近接して使用されると、受信障害を引き起こすことがあります。
取扱説明書に従って正しい取り扱いをして下さい。









Korean Class B statement translation: this is household equipment that is certified to comply with EMC requirements. You may use this equipment in residential environments and other non-residential environments.

이 기기는 가정용으로 전자파적합등록을 한 기기로서
주거지역에서는 물론 모든 지역에서 사용할 수 있습니다.

2.9.5 Product Certification Markings (Board Level)

Desktop Board D201GLY has the product certification markings shown in Table 28:

Table 28. Product Certification Markings

Description	Mark
UL joint US/Canada Recognized Component mark. Includes adjacent UL file number for Intel desktop boards: E210882.	
FCC Declaration of Conformity logo mark for Class B equipment. Includes Intel name and D201GLY model designation.	
CE mark. Declaring compliance to European Union (EU) EMC directive and Low Voltage directive.	
Australian Communications Authority (ACA) C-tick mark. Includes adjacent Intel supplier code number, N-232.	
Japan VCCI (Voluntary Control Council for Interference) mark.	
<p>S. Korea MIC (Ministry of Information and Communication) mark. Includes adjacent MIC certification number: CPU-D201GLY (B)</p> <p>For information about MIC certification, go to http://support.intel.com/support/motherboards/desktop/</p>	
Taiwan BSMI (Bureau of Standards, Metrology and Inspections) mark. Includes adjacent Intel company number, D33025.	
Printed wiring board manufacturer’s recognition mark. Consists of a unique UL recognized manufacturer’s logo, along with a flammability rating (solder side).	<p>V-0</p>
<p>China RoHS/Environmentally Friendly Use Period Logo: This an example of the symbol used on Intel Desktop Boards and associated collateral. The color of the mark may vary depending upon the application. The Environmental Friendly Usage Period (EFUP) for Intel Desktop Boards has been determined to be 10 years.</p>	

3 Overview of BIOS Features

What This Chapter Contains

3.1	Introduction	63
3.2	BIOS Flash Memory Organization	64
3.3	Resource Configuration	64
3.4	System Management BIOS (SMBIOS)	65
3.5	Legacy USB Support	66
3.6	BIOS Updates	66
3.7	Boot Options.....	67
3.8	Adjusting Boot Speed.....	68
3.9	BIOS Security Features	70

3.1 Introduction

The board uses an Intel BIOS that is stored in the SPI Flash device and can be updated using a disk-based program. The SPI Flash device contains the BIOS Setup program, POST, the PCI auto-configuration utility, and Plug and Play support.

The BIOS displays a message during POST identifying the type of BIOS and a revision code. The initial production BIOSs are identified as LY66210M.86A.

When the BIOS Setup configuration jumper is set to configure mode and the computer is powered-up, the BIOS compares the CPU version and the microcode version in the BIOS and reports if the two match.

The BIOS Setup program can be used to view and change the BIOS settings for the computer. The BIOS Setup program is accessed by pressing the <F2> key after the Power-On Self-Test (POST) memory test begins and before the operating system boot begins. The menu bar is shown below.

Maintenance	Main	Advanced	Security	Power	Boot	Exit
-------------	------	----------	----------	-------	------	------

NOTE

The maintenance menu is displayed only when the board is in configure mode. Section 2.3 on page 44 shows how to put the board in configure mode.

Table 29 lists the BIOS Setup program menu features.

Table 29. BIOS Setup Program Menu Bar

Maintenance	Main	Advanced	Security	Power	Boot	Exit
Clears passwords and displays processor information	Displays processor and memory configuration	Configures advanced features available through the chipset	Sets passwords and security features	Configures power management features and power supply controls	Selects boot options	Saves or discards changes to Setup program options

Table 30 lists the function keys available for menu screens.

Table 30. BIOS Setup Program Function Keys

BIOS Setup Program Function Key	Description
<←> or <→>	Selects a different menu screen (Moves the cursor left or right)
<↑> or <↓>	Selects an item (Moves the cursor up or down)
<Tab>	Selects a field (Not implemented)
<Enter>	Executes command or selects the submenu
<F9>	Load the default configuration values for the current menu
<F10>	Save the current values and exits the BIOS Setup program
<Esc>	Exits the menu

3.2 BIOS Flash Memory Organization

The SPI Flash device includes a 4-Mbit (512 KB) flash memory device.

3.3 Resource Configuration

3.3.1 PCI Autoconfiguration

The BIOS can automatically configure PCI devices. PCI devices may be onboard or add-in cards. Autoconfiguration lets a user insert or remove PCI cards without having to configure the system. When a user turns on the system after adding a PCI card, the BIOS automatically configures interrupts, the I/O space, and other system resources. Any interrupts set to Available in Setup are considered to be available for use by the add-in card.

3.3.2 PCI IDE Support

If you select Auto in the BIOS Setup program, the BIOS automatically sets up the PCI IDE connector with independent I/O channel support. The IDE interface supports hard drives up to ATA-66/100/133 and recognizes any ATAPI compliant devices, including CD-ROM drives, tape drives, and Ultra DMA drives. The interface also supports second-generation SATA drives. The BIOS determines the capabilities of each drive and configures them to optimize capacity and performance. To take advantage of the high capacities typically available today, hard drives are automatically configured for Logical Block Addressing (LBA) and to PIO Mode 3 or 4, depending on the capability of the drive. You can override the auto-configuration options by specifying manual configuration in the BIOS Setup program.

To use ATA-66/100/133 features the following items are required:

- An ATA-66/100/133 peripheral device
- An ATA-66/100/133 compatible cable
- ATA-66/100/133 operating system device drivers

NOTE

Do not connect an ATA device as a slave on the same IDE cable as an ATAPI master device. For example, do not connect an ATA hard drive as a slave to an ATAPI CD-ROM drive.

3.4 System Management BIOS (SMBIOS)

SMBIOS is a Desktop Management Interface (DMI) compliant method for managing computers in a managed network.

The main component of SMBIOS is the Management Information Format (MIF) database, which contains information about the computing system and its components. Using SMBIOS, a system administrator can obtain the system types, capabilities, operational status, and installation dates for system components. The MIF database defines the data and provides the method for accessing this information. The BIOS enables applications such as third-party management software to use SMBIOS. The BIOS stores and reports the following SMBIOS information:

- BIOS data, such as the BIOS revision level
- Fixed-system data, such as peripherals, serial numbers, and asset tags
- Resource data, such as memory size, cache size, and processor speed
- Dynamic data, such as event detection and error logging

Non-Plug and Play operating systems require an additional interface for obtaining the SMBIOS information. The BIOS supports an SMBIOS table interface for such operating systems. Using this support, an SMBIOS service-level application running on a non-Plug and Play operating system can obtain the SMBIOS information.

3.5 Legacy USB Support

Legacy USB support enables USB devices to be used even when the operating system's USB drivers are not yet available. Legacy USB support is used to access the BIOS Setup program, and to install an operating system that supports USB.

Legacy USB support operates as follows:

1. When you apply power to the computer, legacy support is disabled.
2. POST begins.
3. Legacy USB support is enabled by the BIOS allowing you to use a USB keyboard to enter and configure the BIOS Setup program and the maintenance menu.
4. POST completes.
5. The operating system loads. While the operating system is loading, USB keyboards and mice are recognized and may be used to configure the operating system.
6. After the operating system loads the USB drivers, all legacy and non-legacy USB devices are recognized by the operating system, and Legacy USB support from the BIOS is no longer used.

To install an operating system that supports USB, follow the operating system's installation instructions.

3.6 BIOS Updates

The BIOS can be updated using either of the following utilities, which are available on the Intel World Wide Web site:

- Intel® Express BIOS Update utility, which enables automated updating while in the Windows environment. Using this utility, the BIOS can be updated from a file on a hard disk, a USB drive (a flash drive or a USB hard drive), or a CD-ROM, or from the file location on the Web.
- Intel® Flash Memory Update Utility, which requires booting from DOS. Using this utility, the BIOS can be updated from a file on a hard disk, a USB drive (a flash drive or a USB hard drive), or a CD-ROM.

Both utilities verify that the updated BIOS matches the target system to prevent accidentally installing an incompatible BIOS.

NOTE

Review the instructions distributed with the upgrade utility before attempting a BIOS update.

For information about	Refer to
BIOS update utilities	http://support.intel.com/support/motherboards/desktop/sb/CS-022312.htm

3.6.1 Language Support

The BIOS Setup program and help messages are supported in US English. Additional languages are available in the Intel® Integrator Toolkit utility. Check the Intel website for details.

3.6.2 Custom Splash Screen

During POST, an Intel® splash screen is displayed by default. This splash screen can be augmented with a custom splash screen. The Intel Integrator Toolkit that is available from Intel can be used to create a custom splash screen.

⇒ NOTE

If you add a custom splash screen, it will share space with the Intel branded logo.

For information about

Intel® Integrator Toolkit

Refer to

<http://developer.intel.com/design/motherbd/software/itk/>

3.7 Boot Options

In the BIOS Setup program, the user can choose to boot from a hard drive, CD-ROM, or the network. The default setting is for the hard drive to be the first boot device, the ATAPI CD-ROM second, and the network third. The fourth device is disabled.

3.7.1 CD-ROM Boot

Booting from CD-ROM is supported in compliance to the El Torito bootable CD-ROM format specification. Under the Boot menu in the BIOS Setup program, ATAPI CD-ROM is listed as a boot device. Boot devices are defined in priority order. Accordingly, if there is not a bootable CD in the CD-ROM drive, the system will attempt to boot from the next defined drive.

3.7.2 Network Boot

The network can be selected as a boot device. This selection allows booting from the onboard LAN or a network add-in card with a remote boot ROM installed.

Pressing the <F12> key during POST automatically forces booting from the LAN. To use this key during POST, the User Access Level in the BIOS Setup program's Security menu must be set to Full.

3.7.3 Booting Without Attached Devices

For use in embedded applications, the BIOS has been designed so that after passing the POST, the operating system loader is invoked even if the following devices are not present:

- Video adapter
- Keyboard
- Mouse

3.7.4 Changing the Default Boot Device During POST

Pressing the <F10> key during POST causes a boot device menu to be displayed. This menu displays the list of available boot devices (as set in the BIOS setup program's Boot Device Priority Submenu). Table 31 lists the boot device menu options.

Table 31. Boot Device Menu Options

Boot Device Menu Function Keys	Description
<↑> or <↓>	Selects a default boot device
<Enter>	Exits the menu, saves changes, and boots from the selected device
<Esc>	Exits the menu without saving changes

3.8 Adjusting Boot Speed

These factors affect system boot speed:

- Selecting and configuring peripherals properly
- Optimized BIOS boot parameters

3.8.1 Peripheral Selection and Configuration

The following techniques help improve system boot speed:

- Choose a hard drive with parameters such as "power-up to data ready" less than eight seconds, that minimize hard drive startup delays.
- Select a CD-ROM drive with a fast initialization rate. This rate can influence POST execution time.
- Eliminate unnecessary add-in adapter features, such as logo displays, screen repaints, or mode changes in POST. These features may add time to the boot process.
- Try different monitors. Some monitors initialize and communicate with the BIOS more quickly, which enables the system to boot more quickly.

3.8.2 BIOS Boot Optimizations

Use of the following BIOS Setup program settings reduces the POST execution time.

- In the Boot Menu, set the hard disk drive as the first boot device. As a result, the POST does not first seek a diskette drive, which saves about one second from the POST execution time.
- In the Peripheral Configuration submenu, disable the LAN device if it will not be used. This can reduce up to four seconds of option ROM boot time.

NOTE

It is possible to optimize the boot process to the point where the system boots so quickly that the Intel logo screen (or a custom logo splash screen) will not be seen. Monitors and hard disk drives with minimum initialization times can also contribute to a boot time that might be so fast that necessary logo screens and POST messages cannot be seen.

This boot time may be so fast that some drives might be not be initialized at all. If this condition should occur, it is possible to introduce a programmable delay ranging from three to 30 seconds (using the Hard Disk Pre-Delay feature of the Advanced Menu in the Drive Configuration Submenu of the BIOS Setup program).

3.9 BIOS Security Features

The BIOS includes security features that restrict access to the BIOS Setup program and who can boot the computer. A supervisor password and a user password can be set for the BIOS Setup program and for booting the computer, with the following restrictions:

- The supervisor password gives unrestricted access to view and change all the Setup options in the BIOS Setup program. This is the supervisor mode.
- The user password gives restricted access to view and change Setup options in the BIOS Setup program. This is the user mode.
- If only the supervisor password is set, pressing the <Enter> key at the password prompt of the BIOS Setup program allows the user restricted access to Setup.
- If both the supervisor and user passwords are set, users can enter either the supervisor password or the user password to access Setup. Users have access to Setup respective to which password is entered.
- Setting the user password restricts who can boot the computer. The password prompt will be displayed before the computer is booted. If only the supervisor password is set, the computer boots without asking for a password. If both passwords are set, the user can enter either password to boot the computer.
- For enhanced security, use different passwords for the supervisor and user passwords.
- Valid password characters are A-Z, a-z, and 0-9. Passwords may be up to 16 characters in length.

Table 32 shows the effects of setting the supervisor password and user password. This table is for reference only and is not displayed on the screen.

Table 32. Supervisor and User Password Functions

Password Set	Supervisor Mode	User Mode	Setup Options	Password to Enter Setup	Password During Boot
Neither	Can change all options (Note)	Can change all options (Note)	None	None	None
Supervisor only	Can change all options	Can change a limited number of options	Supervisor Password	Supervisor	None
User only	N/A	Can change all options	Enter Password Clear User Password	User	User
Supervisor and user set	Can change all options	Can change a limited number of options	Supervisor Password Enter Password	Supervisor or user	Supervisor or user

Note: If no password is set, any user can change all Setup options.

4 Error Messages

What This Chapter Contains

4.1 BIOS Front-panel Power LED Codes.....	71
4.2 BIOS Error Messages	71
4.3 Port 80h POST Codes	72

4.1 BIOS Front-panel Power LED Codes

The front-panel power LED blinks off and on to display messages. For example, the power LED is on when the system is powered on, and blinks off for 0.5 second when processor initialization is complete. In addition, whenever a recoverable error occurs during POST, the BIOS causes the front-panel power LED to blink an error message describing the problem (see Table 33).

Table 33. Front-panel Power LED Blink Codes

Type	Pattern
Processor initialization complete	On when system powers up, then off for 0.5 second.
POST complete	On when system powers up, then off for 0.5 second.
BIOS update in progress	Off when update begins, then on for 0.5 second, then off for 0.5 second; pattern repeats until BIOS update is complete.
Video error	On-off (0.5 second each) two times, then 3.0 second pause (off) between on-off blink pattern; repeat entire pattern (two on-off blinks and pause) until system is powered off.
Memory error	On-off (0.5 second each) three times, then 3.0 second pause (off) between on-off blink pattern; repeat entire pattern (three on-off blinks and 3-second pause) until system is powered off.
Thermal warning	On-off (0.5 second each) four times, then 3.0 second pause (off) between on-off blink pattern; repeat entire pattern (four on-off blinks and 3-second pause) until 16 th on blink, then end.

4.2 BIOS Error Messages

Table 34 lists the error messages and provides a brief description of each.

Table 34. BIOS Error Messages

Error Message	Explanation
CMOS Battery Low	The battery may be losing power. Replace the battery soon.
CMOS Checksum Bad	The CMOS checksum is incorrect. CMOS memory may have been corrupted. Run Setup to reset values.
Memory Size Decreased	Memory size has decreased since the last boot. If no memory was removed, then memory may be bad.
No Boot Device Available	System did not find a device to boot.

4.3 Port 80h POST Codes

During the POST, the BIOS generates diagnostic progress codes (POST codes) to I/O port 80h. If the POST fails, execution stops and the last POST code generated is left at port 80h. This code is useful for determining the point where an error occurred.

Displaying the POST codes requires a PCI bus add-in card, often called a POST card. The POST card can decode the port and display the contents on a medium such as a seven-segment display.

⇒ NOTE

The POST card must be installed in PCI bus connector 1.

The following tables provide information about the POST codes generated by the BIOS:

- Table 35 lists the Port 80h POST code ranges
- Table 36 lists the Port 80h POST codes themselves
- Table 37 lists the Port 80h POST sequence

⇒ NOTE

In the tables listed above, all POST codes and range values are listed in hexadecimal.

Table 35. Port 80h POST Code Ranges

Range	Category/Subsystem
00 – 0F	Debug codes: Can be used by any PEIM/driver for debug.
10 – 1F	Host Processors: 1F is an unrecoverable CPU error.
20 – 2F	Memory/Chipset: 2F is no memory detected or no useful memory detected.
30 – 3F	Recovery: 3F indicated recovery failure.
40 – 4F	Reserved for future use.
50 – 5F	I/O Busses: PCI, USB, ISA, ATA, etc. 5F is an unrecoverable error. Start with PCI.
60 – 6F	Reserved for future use (for new busses).
70 – 7F	Output Devices: All output consoles. 7F is an unrecoverable error.
80 – 8F	Reserved for future use (new output console codes).
90 – 9F	Input devices: Keyboard/Mouse. 9F is an unrecoverable error.
A0 – AF	Reserved for future use (new input console codes).
B0 – BF	Boot Devices: Includes fixed media and removable media. BF is an unrecoverable error.
C0 – CF	Reserved for future use.
D0 – DF	Boot device selection.
E0 – FF	E0 – EE: Miscellaneous codes. See Table 36. EF: boot/S3 resume failure. F0 – FF: FF processor exception.

Table 36. Port 80h POST Codes

POST Code	Description of POST Operation
Host Processor	
10	Power-on initialization of the host processor (Boot Strap Processor)
11	Host processor cache initialization (including APs)
12	Starting Application processor initialization
13	SMM initialization
Chipset	
21	Initializing a chipset component
Memory	
22	Reading SPD from memory DIMMs
23	Detecting presence of memory DIMMs
24	Programming timing parameters in the memory controller and the DIMMs
25	Configuring memory
26	Optimizing memory settings
27	Initializing memory, such as ECC init
28	Testing memory
PCI Bus	
50	Enumerating PCI busses
51	Allocating resources to PCI bus
52	Hot Plug PCI controller initialization
53 – 57	Reserved for PCI Bus
USB	
58	Resetting USB bus
59	Reserved for USB
ATA/ATAPI	
5A	Resetting PATA bus and all devices
5B	Reserved for ATA
SMBus	
5C	Resetting SMBus
5D	Reserved for SMBus
Local Console	
70	Resetting the VGA controller
71	Disabling the VGA controller
72	Enabling the VGA controller
Remote Console	
78	Resetting the console controller
79	Disabling the console controller
7A	Enabling the console controller

continued

Table 36. Port 80h POST Codes (continued)

POST Code	Description of POST Operation
Keyboard (PS/2 or USB)	
90	Resetting keyboard
91	Disabling keyboard
92	Detecting presence of keyboard
93	Enabling keyboard
94	Clearing keyboard input buffer
95	Instructing keyboard controller to run Self Test (PS/2 only)
Mouse (PS/2 or USB)	
98	Resetting mouse
99	Disabling mouse
9A	Detecting presence of mouse
9B	Enabling mouse
Fixed Media	
B0	Resetting fixed media
B1	Disabling fixed media
B2	Detecting presence of a fixed media (IDE hard drive detection etc.)
B3	Enabling/configuring a fixed media
Removable media	
B8	Resetting removable media
B9	Disabling removable media
BA	Detecting presence of a removable media (IDE, CD-ROM detection, etc.)
BC	Enabling/configuring a removable media
BDS	
Dy	Trying boot selection y (y=0 to 15)
PEI Core	
E0	Started dispatching PEIMs (emitted on first report of EFI_SW_PC_INIT_BEGIN EFI_SW_PEI_PC_HANDOFF_TO_NEXT)
E2	Permanent memory found
E1, E3	Reserved for PEI/PEIMs
DXE Core	
E4	Entered DXE phase
E5	Started dispatching drivers
E6	Started connecting drivers

continued

Table 36. Port 80h POST Codes (continued)

POST Code	Description of POST Operation
	DXE Drivers
E7	Waiting for user input
E8	Checking password
E9	Entering BIOS setup
EB	Calling Legacy Option ROMs
EF	TBD – Unrecoverable Boot failure/S3 resume failure
	Runtime Phase/EFI OS Boot
F4	Entering Sleep state
F5	Exiting Sleep state
F8	EFI boot service ExitBootServices () has been called
F9	EFI runtime service SetVirtualAddressMap () has been called
FA	EFI runtime service ResetSystem () has been called
	PEIMs/Recovery
30	Crisis Recovery has initiated per user request
31	Crisis Recovery has initiated by software (corrupt flash)
34	Loading recovery capsule
35	Handing off control to the recovery capsule
3F	Unable to recover

Table 37. Typical Port 80h POST Sequence

POST Code	Description
21	Initializing a chipset component
22	Reading SPD from memory DIMMs
23	Detecting presence of memory DIMMs
25	Configuring memory
28	Testing memory
34	Loading recovery capsule
E4	Entered DXE phase
12	Starting Application processor initialization
13	SMM initialization
50	Enumerating PCI busses
51	Allocating resources to PCI bus
92	Detecting the presence of the keyboard
90	Resetting keyboard
94	Clearing keyboard input buffer
95	Keyboard Self Test
EB	Calling Video BIOS
58	Resetting USB bus
5A	Resetting PATA/SATA bus and all devices
92	Detecting the presence of the keyboard
90	Resetting keyboard
94	Clearing keyboard input buffer
5A	Resetting PATA bus and all devices
28	Testing memory
90	Resetting keyboard
94	Clearing keyboard input buffer
E7	Waiting for user input
01	INT 19
00	Ready to boot