

## Features

- $S_{21}$  = 24.7 dB @ 2300 MHz  
= 25.3 dB @ 2360 MHz
- NF of 0.88 dB over Frequency
- Unconditionally Stable
- Single 5V Supply
- High OIP3 @ Low Current

## Description

The plerow™ ALN-series is the compactly designed surface-mount module for the use of the LNA with or without the following gain blocks in the infrastructure equipment of the mobile wireless (CDMA, GSM, PCS, PHS, WCDMA, DMB, WLAN, WiBro, WiMAX), GPS, satellite communication terminals, CATV and so on. It has an exceptional performance of low noise figure, high gain, high OIP3, and low bias current. The stability factor is always kept more than unity over the application band in order to ensure its unconditionally stable implementation to the application system environment. The surface-mount module package including the completed matching circuit and other components necessary just in case allows very simple and convenient implementation onto the system board in mass production level.

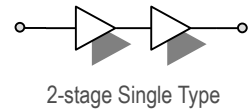

## Specifications (in Production)

Typ. @ T = 25°C,  $V_s$  = 5 V, Freq. = 2330 MHz,  $Z_{o.sys}$  = 50 ohm

Parameter	Unit	Specifications		
		Min	Typ	Max
Frequency Range	MHz	2300		2360
Gain	dB	24	25	
Gain Flatness	dB		± 0.3	± 0.5
Noise Figure	dB		0.88	0.93
Output IP3 <sup>(1)</sup>	dBm	35	36	
S11 / S22 <sup>(2)</sup>	dB			-15 / -12
Output P1dB	dBm	19	20	
Switching Time <sup>(3)</sup>	μsec		-	
Supply Current	mA		165	185
Supply Voltage	V		5	
Impedance	Ω		50	
Max. RF Input Power	dBm	C.W 29 ~ 31 (before fail)		
Package Type & Size	mm	Surface Mount Type, 13Wx13Lx3.8H		

Operating temperature is -40°C to +85°C.

1) OIP3 is measured with two tones at an output power of 10 dBm / tone separated by 1 MHz.

2) S11/S22 (max) is the worst value within the frequency band.

3) Switching time means the time that takes for output power to get stabilized to its final level after switching DC voltage from 0 V to  $V_s$ .

## More Information

Website: [www.asb.co.kr](http://www.asb.co.kr)  
E-mail: [sales@asb.co.kr](mailto:sales@asb.co.kr)

Tel: (82) 42-528-7223  
Fax: (82) 42-528-7222

ASB Inc., 4th Fl. Venture Town  
Bldg., 367-17 Goijeong-Dong,  
Seo-Gu, Daejeon 302-716, Korea

## Outline Drawing (Unit: mm)

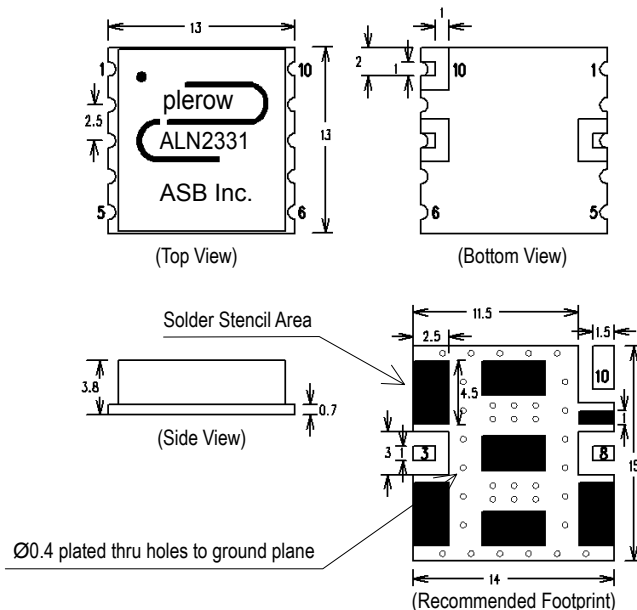

Pin Number	Function
3	RF In
8	RF Out
10	$V_s$
Others	Ground

Note: 1. The number and size of ground via holes in a circuit board is critical for thermal RF grounding considerations.

2. We recommend that the ground via holes be placed on the bottom of all ground pins for better RF and thermal performance, as shown in the drawing at the left side.

**Typical Performance  
(Measured)**

---

**2300~2360**

---

**+5 V**

---

**S-parameters**

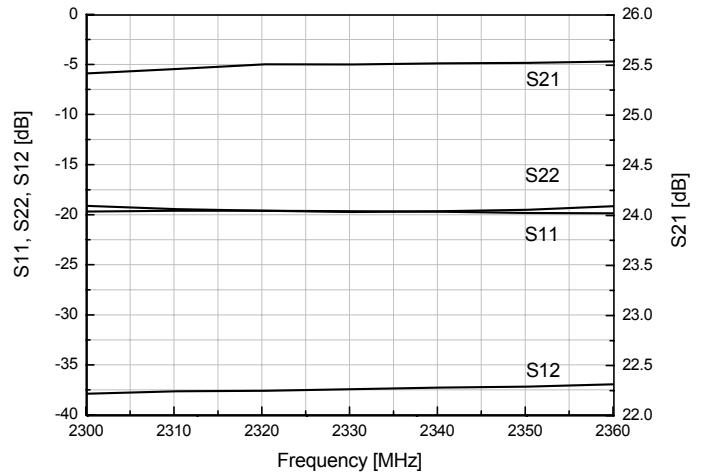

**S-parameters & K Factor**

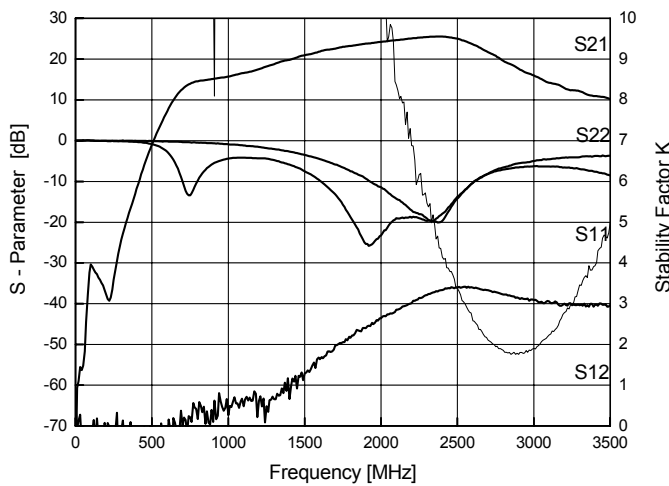

**Noise Figure**

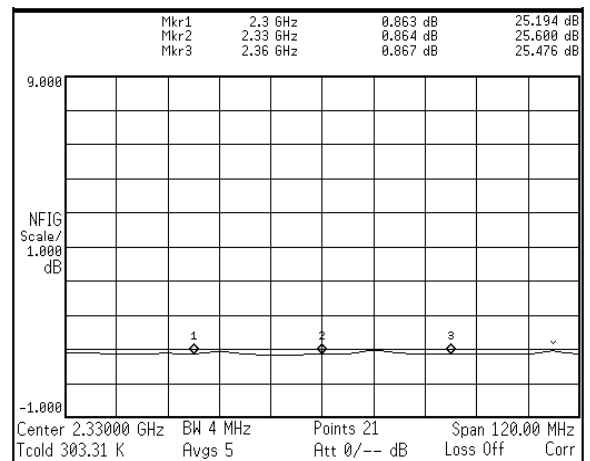

**OIP3**

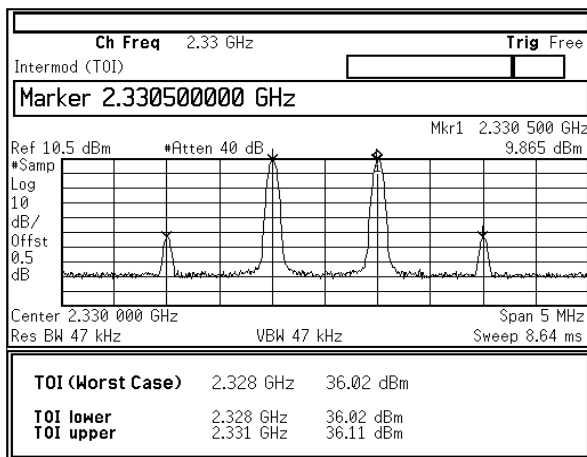

**P1dB**

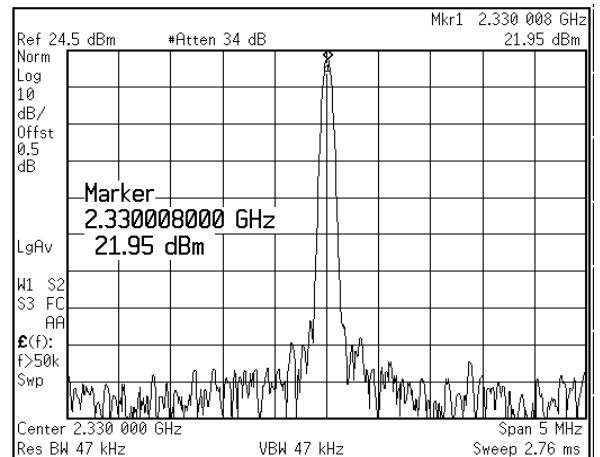

### Application Circuit

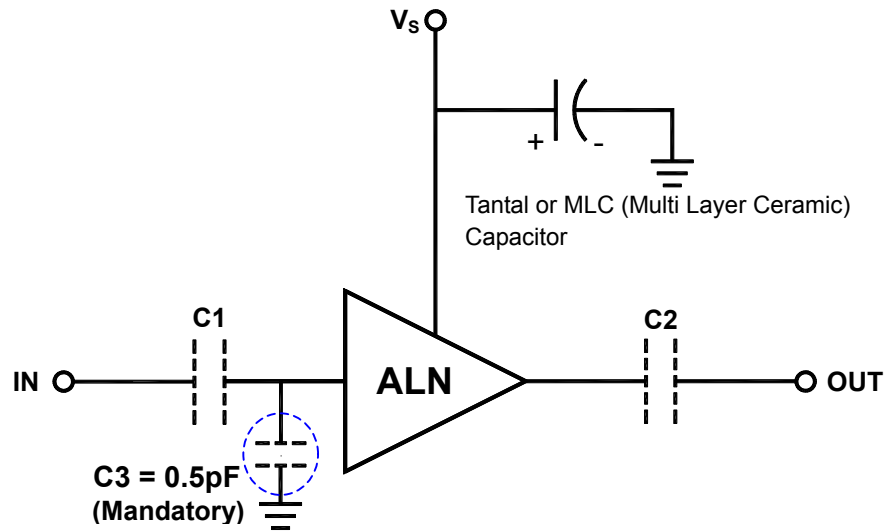

- 1) The tantalum or MLC (Multi Layer Ceramic) capacitor is optional and for bypassing the AC noise introduced from the DC supply. The capacitance value may be determined by customer's DC supply status. The capacitor should be placed as close as possible to  $V_s$  pin and be connected directly to the ground plane for the best electrical performance.
- 2) DC blocking capacitors are always necessarily placed at the input and output port for allowing only the RF signal to pass and blocking the DC component in the signal. The DC blocking capacitors are included inside the ALN module. Therefore, C1 & C2 capacitors may not be necessary, but can be added just in case that the customer wants. The value of C1 & C2 is determined by considering the application frequency. C3 shall be used for matching.

### Recommended Soldering Reflow Process

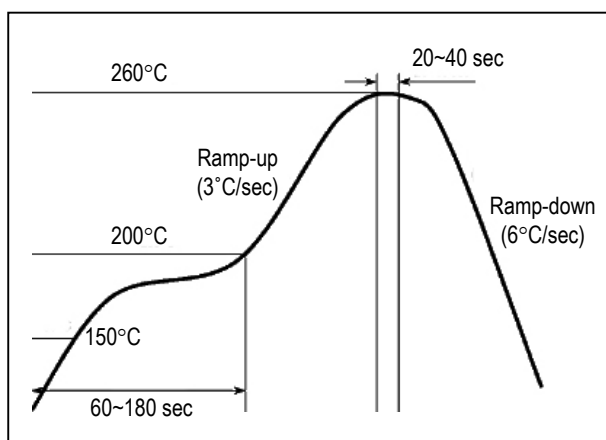

### Evaluation Board Layout

