

Features

- $S_{21} = 26.3 \text{ dB @ } 1920 \text{ MHz}$
= $24.7 \text{ dB @ } 2170 \text{ MHz}$
- NF of 0.95 dB over Frequency
- Unconditionally Stable
- Single 5V Supply
- High OIP3 @ Low Current

Description

The plerow™ ALN-series is the compactly designed surface-mount module for the use of the LNA with or without the following gain blocks in the infrastructure equipment of the mobile wireless (CDMA, GSM, PCS, PHS, WCDMA, DMB, WLAN, WiBro, WiMAX), GPS, satellite communication terminals, CATV and so on. It has an exceptional performance of low noise figure, high gain, high OIP3, and low bias current. The stability factor is always kept more than unity over the application band in order to ensure its unconditionally stable implementation to the application system environment. The surface-mount module package including the completed matching circuit and other components necessary just in case allows very simple and convenient implementation onto the system board in mass production level.

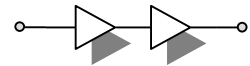

2-stage Single Type

Specifications (in Production)

Typ. @ T = 25°C, $V_s = 5 \text{ V}$, Freq. = 2045 MHz, $Z_{o,sys} = 50 \text{ ohm}$

Parameter	Unit	Specifications		
		Min	Typ	Max
Frequency Range	MHz	1920		2170
Gain	dB	24.5	25.5	
Gain Flatness	dB		± 0.8	± 1.0
Noise Figure	dB		0.95	1.0
Output IP3 ⁽¹⁾	dBm	35.5	36.5	
S11 / S22 ⁽²⁾	dB			-18 / -10
Output P1dB	dBm	19.5	20.5	
Switching Time ⁽³⁾	μsec		-	
Supply Current	mA		110	130
Supply Voltage	V		5	
Impedance	Ω		50	
Max. RF Input Power	dBm	C.W 23 ~ 25 (before fail)		
Package Type & Size	mm	Surface Mount Type, 10Wx10Lx3.8H		

Operating temperature is -40°C to +85°C.

1) OIP3 is measured with two tones at an output power of 10 dBm / tone separated by 1 MHz.

2) S11/S22 (max) is the worst value within the frequency band.

3) Switching time means the time that takes for output power to get stabilized to its final level after switching DC voltage from 0 V to V_s .

More Information

Website: www.asb.co.kr
E-mail: sales@asb.co.kr

Tel: (82) 42-528-7223
Fax: (82) 42-528-7222

ASB Inc., 4th Fl. Venture Town Bldg., 367-17 Goijeong-Dong, Seo-Gu, Daejeon 302-716, Korea

Outline Drawing (Unit: mm)

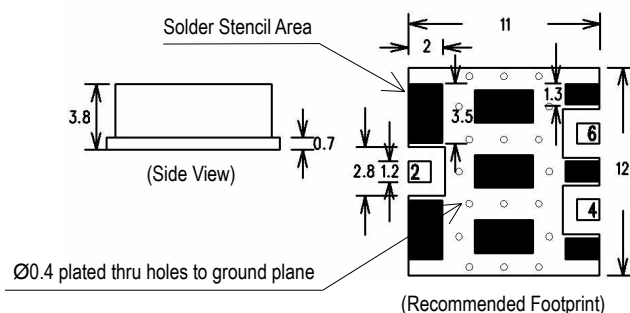
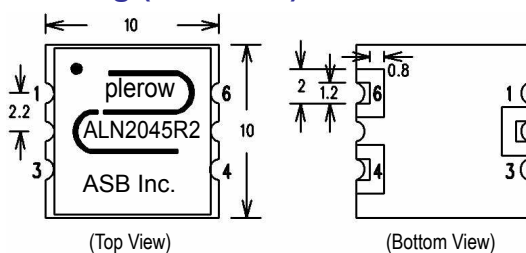

Pin Number	Function
2	RF In
4	+Vcc
6	RF Out
Others	Ground

Note: 1. The number and size of ground via holes in a circuit board is critical for thermal RF grounding considerations.

2. We recommend that the ground via holes be placed on the bottom of all ground pins for better RF and thermal performance, as shown in the drawing at the left side.

**Typical Performance
(Measured)**

1920~2170
+5 V

S-parameters

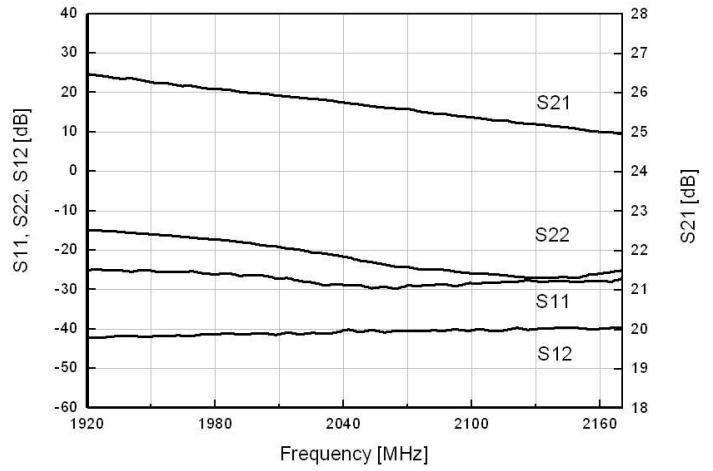

S-parameters & K Factor

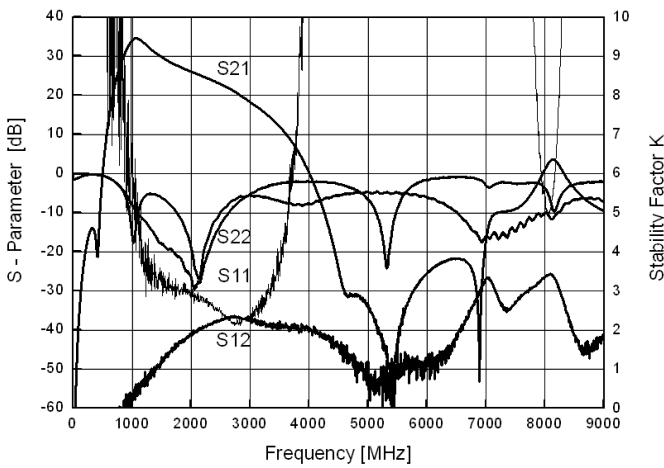

Noise Figure

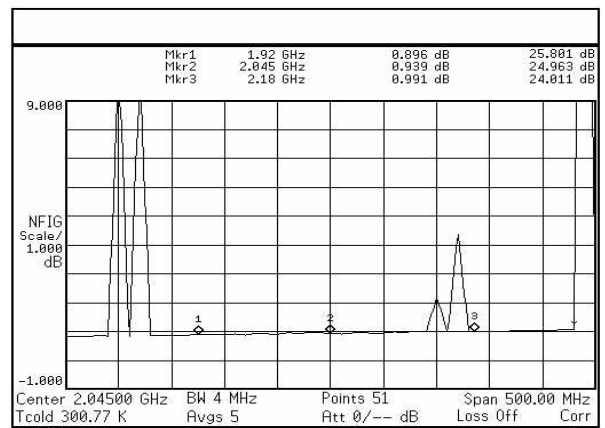

OIP3

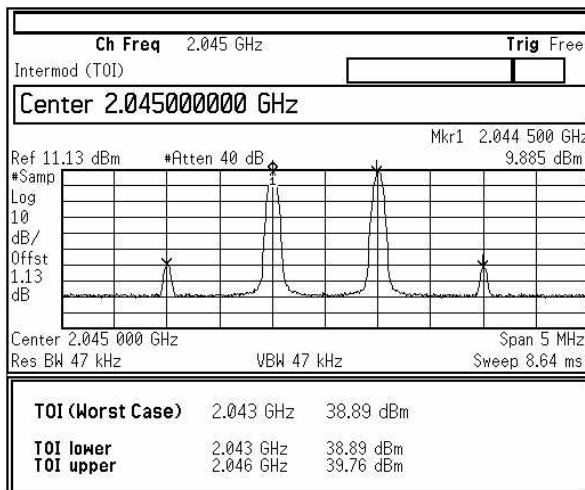

P1dB

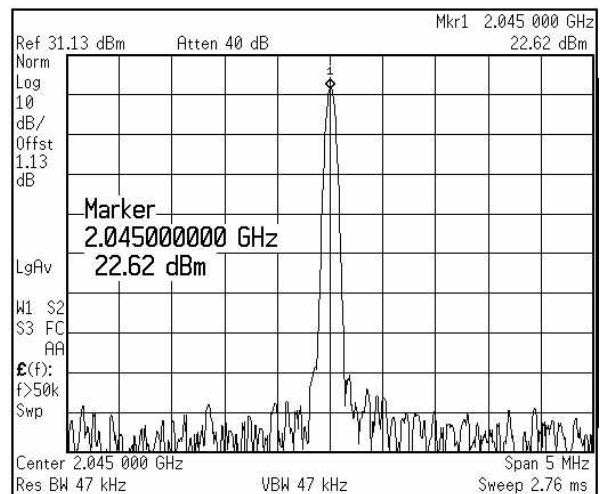

**Typical Performance
(Measured)**

1970 ± 15

+5 V

S-parameters

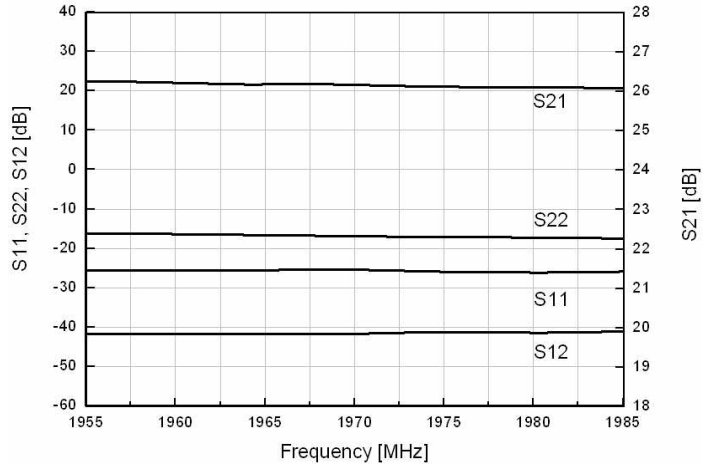

Stability Factor (K)

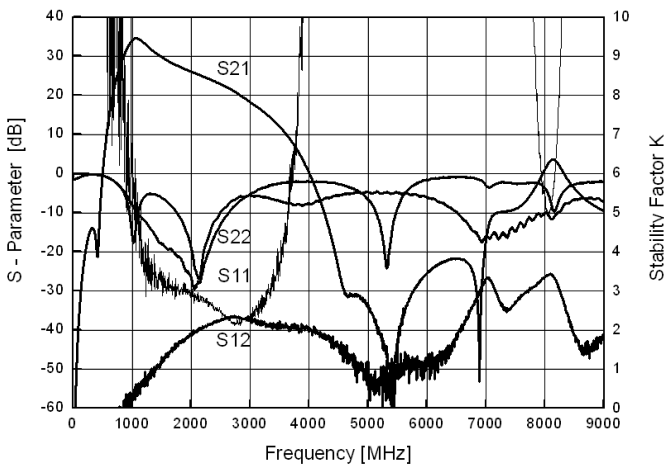

Noise Figure

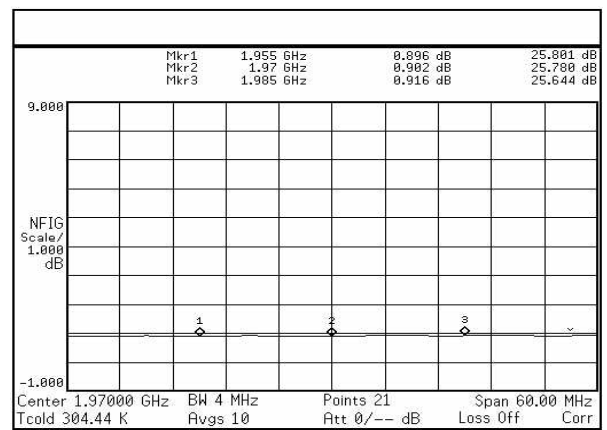

OIP3

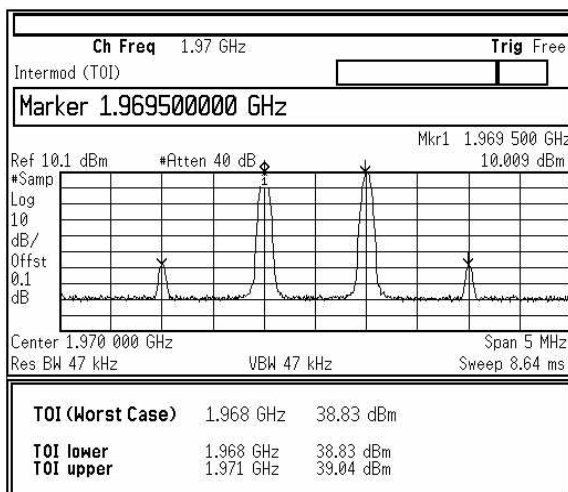

P1dB

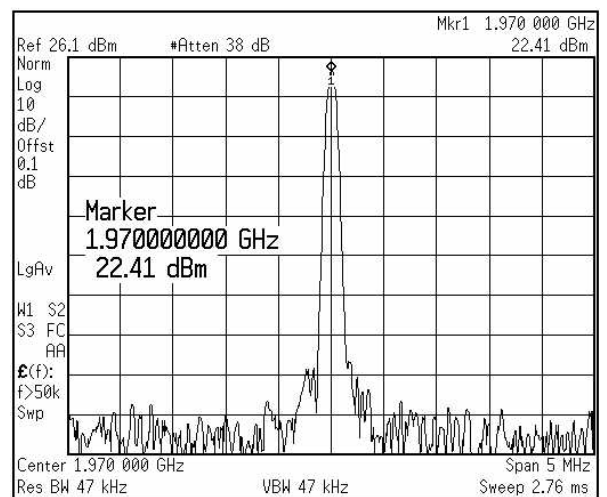

**Typical Performance
(Measured)**

2160 ± 15

+5 V

S-parameters

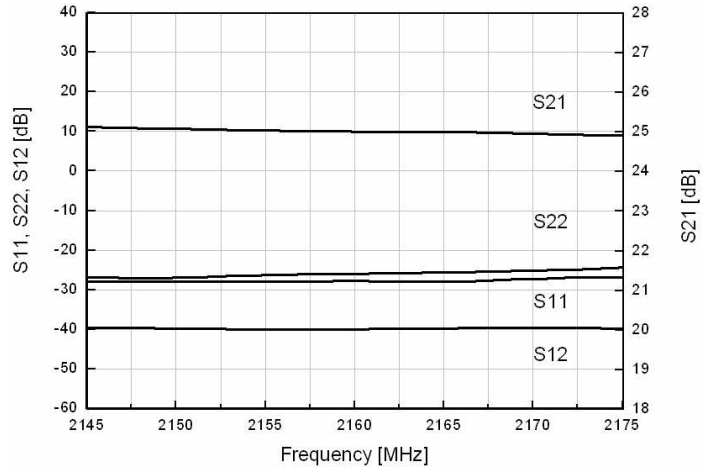

Stability Factor (K)

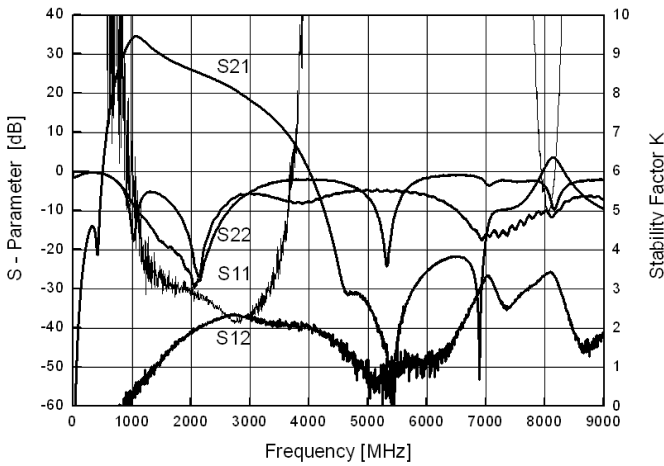

Noise Figure

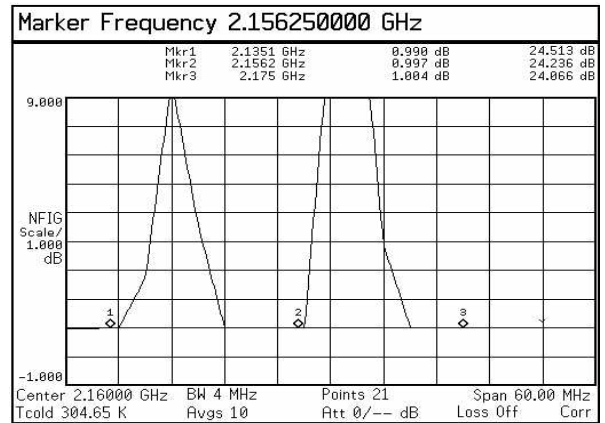

OIP3

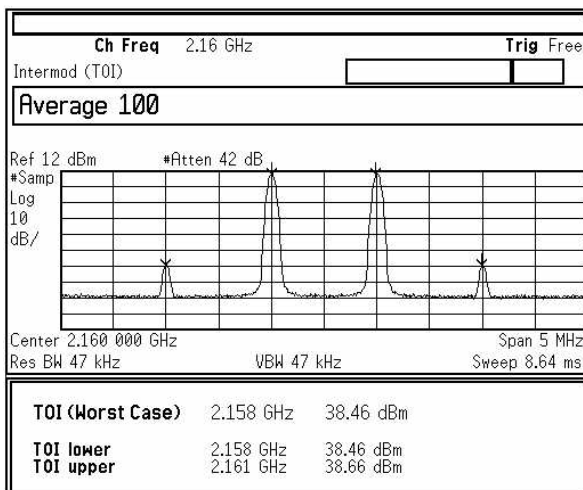

P1dB

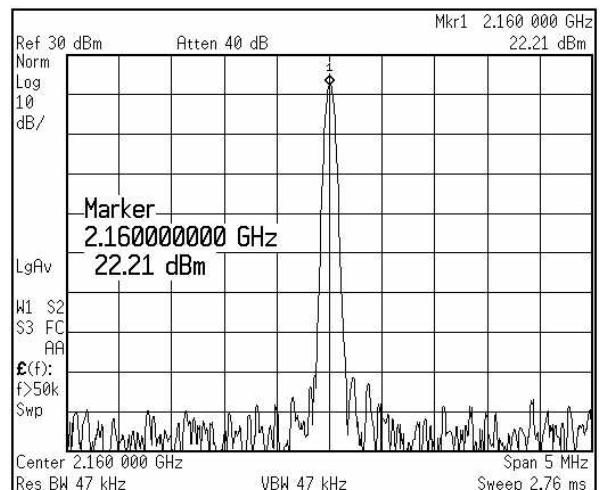

RF Performance with Voltage Change

Item Voltage	S11 (dB)	S22 (dB)	S21 (dB)	G/F (dB)	NF (dB)	P1dB (dBm)	OIP3 (dBm)	Current (mA)
4.5	-19.18	-16.30	25.17	1.68	0.953	21.57	34.72	83
4.6	-19.31	-16.21	25.25	1.71	0.954	21.79	35.94	89
4.7	-19.39	-16.18	25.32	1.68	0.967	22.00	37.04	95
4.8	-19.45	-16.19	25.37	1.70	0.986	22.17	38.20	100
4.9	-19.51	-16.15	25.43	1.67	0.978	22.46	38.60	106
5.0	-19.59	-16.15	25.47	1.69	0.980	22.62	38.84	112
5.1	-19.65	-16.14	25.47	1.69	0.997	22.75	38.94	117
5.2	-19.73	-16.16	25.50	1.69	1.018	22.90	39.06	123
5.3	-19.74	-16.15	25.56	1.67	1.007	23.11	39.03	128
5.4	-19.90	-16.17	25.58	1.70	1.019	23.25	38.87	134
5.5	-19.91	-16.18	25.60	1.69	1.040	23.38	38.78	139

RF Performance with Operating Temperature

Item Temp.	S11 (dB)	S22 (dB)	S21 (dB)	G/F (dB)	NF (dB)	P1dB (dBm)	OIP3 (dBm)	Current (mA)
-40°C	-19.14	-15.89	25.93	1.68	0.698	23.18	39.10	104
-20°C	-19.23	-16.07	25.77	1.69	0.771	23.10	39.09	106
0°C	-19.17	-16.13	25.60	1.70	0.860	22.92	39.05	108
25°C	-19.15	-16.01	25.34	1.72	0.986	22.62	38.89	111
40°C	-19.10	-16.26	25.20	1.73	1.117	22.43	38.63	112
60°C	-18.86	-16.37	25.04	1.73	1.243	22.07	37.41	113
80°C	-18.86	-16.41	24.84	1.73	1.297	21.64	35.66	113
100°C	-18.82	-16.51	24.52	1.73	1.454	21.06	34.19	112

Application Circuit

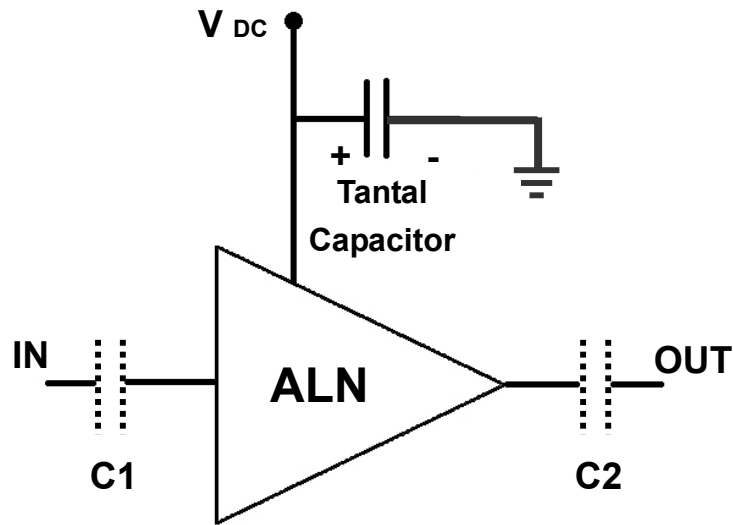

- 1) The tantal capacitor is optional and for bypassing the AC noise introduced from the DC supply. The capacitance value may be determined by customer's DC supply status.
- 2) So-called DC blocking capacitors are always necessarily placed at the input and output port for allowing only the RF signal to pass and blocking the DC component in the signal. The DC blocking capacitors are included inside the LNA module. Therefore, C1 & C2 capacitors may not be necessary, but can be added just in case that the customer wants. The value of C1 & C2 is determined by considering the application frequency.

Recommended Soldering Reflow Process

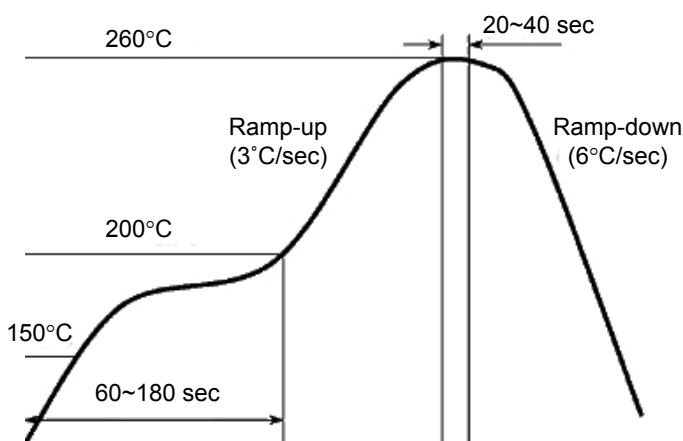

Evaluation Board Layout

