

QUAD/DUAL EPAD® PRECISION N-CHANNEL MATCHED PAIR MOSFET ARRAY

GENERAL DESCRIPTION

ALD1121E/ALD1123E are monolithic quad/dual EPAD® (Electrically Programmable Analog Device) N-channel MOSFETs with electrically adjustable threshold (turn-on) voltage. The ALD1121E/ALD1123E are precision matched and adjusted (e-trimmed) at the factory resulting in quad/dual MOSFETs that are highly matched in electrical characteristics. The ALD1123E has four (4) separate source pins. S_{N1} , S_{N2} share a common substrate pin, $V^{-}1$, which has to be connected to the most negative voltage potential. Likewise, S_{N3} , S_{N4} share a common substrate pin, $V^{-}2$, which has to be connected to the negative voltage potential for S_{N3} , S_{N4} . The ALD1121E has two (2) separate source pins (S_{N1} , S_{N2}). Both S_{N1} , S_{N2} share a common substrate, pin 4, which has to be connected to the most negative voltage potential. For a given input voltage, the threshold voltage of a MOSFET device determines its drain on-current, resulting in an on-resistance characteristic that can be precisely preset and then controlled by the input voltage very accurately.

Using an ALD1121E/ALD1123E is simple and straight forward. The MOSFETs function as n-channel MOSFETs, except that all the devices have exceptional matching to each other in electrical characteristics. For a given input voltage, the threshold voltage of a MOSFET device determines its drain on-current, resulting in an on-resistance characteristic that can be precisely preset and then controlled by the input voltage very accurately. Since these devices are on the same monolithic chip, they also exhibit excellent tempco matching characteristics.

ORDERING INFORMATION ("L" suffix denotes lead-free (RoHS))

| Operating Temperature Range* | | |
|------------------------------|----------------------------|-----------------------|
| 0°C to +70°C | 0°C to +70°C | -55°C to +125°C |
| 8-Pin SOIC Package | 8-Pin Plastic Dip Package | 8-Pin Cerdip Package |
| ALD1121ESAL | ALD1121EPAL | ALD1121EDA |
| 16-Pin SOIC Package | 16-Pin Plastic Dip Package | 16-Pin Cerdip Package |
| ALD1123ESCL | ALD1123EPCL | ALD1123EDC |

* Contact factory for leaded (non-RoHS) or high temperature versions.

BLOCK DIAGRAM

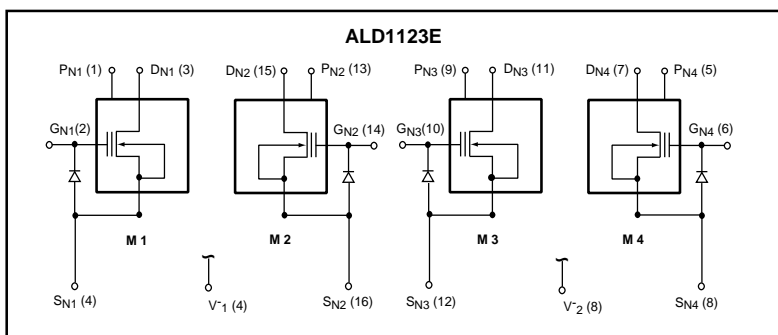

BENEFITS

- Precision matched electrically after packaging
- Simple, elegant single-chip user option to trim voltage/current values
- Excellent device matching characteristics with or without additional electrical trim
- Remotely and electrically trim parameters on circuits that are physically inaccessible

PIN CONFIGURATION

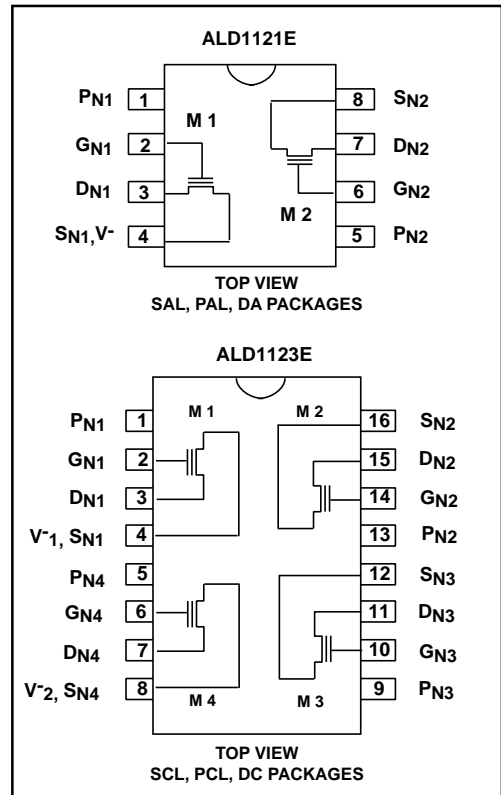

BLOCK DIAGRAM

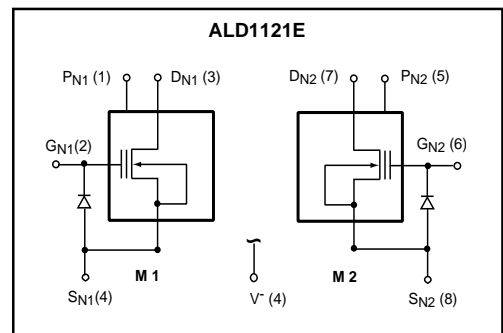

These MOSFET devices have very low input currents and, as a result, a very high input impedance ($>10^{12}$ Ohm). The gate voltage from a control source can drive many MOSFET inputs with practically no loading effects. Used in precision current mirror or current multiplier applications, they can be used to provide a current source over a 100nA to 3mA range, and with either a positive, negative, or zero tempco.

Optional EPAD Threshold Voltage Trimming by User

The basic EPAD MOSFET device is a monotonically adjustable device, which means the device can normally be e-trimmed to increase in threshold voltage and to decrease in drain-on current as a function of a given input bias voltage. Used as an in-circuit element for trimming or setting a combination of voltage current and/or on-resistance characteristics, it can be set up to be e-trimmed remotely and automatically. Once e-trimmed, the set voltage and current levels are stored indefinitely inside the device as a nonvolatile stored charge, which is not affected during normal operation of the device, even when power is turned off. A given EPAD device can be adjusted many times to continually increase its threshold voltage. A pair of EPAD devices can also be connected differentially such that one device is used to adjust a parameter in one direction and the other device is used to adjust the same parameter in the other direction.

The ALD1121E/ALD1123E can be e-trimmed with an ALD EPAD programmer to obtain the desired voltage and current levels. They can also be e-trimmed as an active in-system element in a user system, via user designed interface circuitry. PN₁, PN₂, etc., are pins required for optional e-trim of respective MOSFET devices. If unused, these pins are to be connected to V- or ground. For more information, see Application Note AN1108.

APPLICATIONS

- Precision PC-based electronic calibration
- Automated voltage trimming or setting
- Remote voltage or current adjustment of inaccessible nodes
- PCMCIA based instrumentation trimming
- Electrically adjusted resistive load
- Temperature compensated current sources and current mirrors
- Electrically trimmed/calibrated current sources
- Permanent precision preset voltage level shifter
- Low temperature coefficient voltage and/or current bias circuits
- Multiple preset voltage bias circuits
- Multiple channel resistor pull-up or pull-down circuits
- Microprocessor based process control systems
- Portable data acquisition systems
- Battery operated terminals and instruments
- Remote telemetry systems
- E-trimmable gain amplifiers
- Low level signal conditioning
- Sensor and transducer bias currents
- Neural networks

BENEFITS (cont.)

- Usable in environmentally sealed circuits
- No mechanical moving parts -- high G-shock tolerance
- Improved reliability, dependability, dust and moisture resistance
- Cost and labor savings
- Small footprint for high board density applications

FEATURES

- Electrically Programmable Analog Device
- Proven, non-volatile CMOS technology
- Operates from 2V, 3V, 5V to 10V
- Flexible basic circuit building block and design element
- Very high resolution -- average e-trim voltage resolution of 0.1mV
- Wide dynamic range -- current levels from 0.1μA to 3000μA
- Voltage adjustment range from 1.000V to 3.000V in 0.1mV steps
- Typical 10-year drift of less than 2mV
- Usable in voltage mode or current mode
- High input impedance -- $10^{12}\Omega$
- Very high DC current gain -- greater than 10^9
- Device operating current has positive temperature coefficient range and negative temperature coefficient range with cross-over zero temperature coefficient current level at 68μA
- Tight matching and tracking of on-resistance between different devices with e-trim
- Very low input currents and leakage currents
- Low cost, monolithic technology
- Application-specific or in-system programming modes
- Optional user software-controlled automation
- Optional e-trim of any standard/custom configuration
- Micropower operation
- Available in standard PDIP, SOIC and hermetic CDIP packages
- Suitable for matched-pair balanced circuit configuration
- Suitable for both coarse and fine trimming, as well as matched MOSFET array applications
- RoHS compliant

ABSOLUTE MAXIMUM RATINGS

| | |
|---|---|
| Supply voltage, V ⁺ referenced to V ⁻ | -0.3V to +10.6V |
| Supply voltage, V _S referenced to V ⁻ | ±5.3V |
| Differential input voltage range | -0.3V to +0.3V |
| Power dissipation | 600mW |
| Operating temperature range | SAL, PAL, SCL, PCL packages 0°C to +70°C DA, DC packages -55°C to +125°C |
| Storage temperature range | -65°C to +150°C |
| Lead temperature, 10 seconds | +260°C |

CAUTION: ESD Sensitive Device. Use static control procedures in ESD controlled environment.

OPERATING ELECTRICAL CHARACTERISTICS

T_A = 25°C V⁺ = +5.0V unless otherwise specified

| Parameter | Symbol | ALD1121E | | | ALD1123E | | | Unit | Test Conditions |
|---|---------------------|----------|-----------------------------|-------|----------|-----------------------------|-------|----------------------------------|--|
| | | Min | Typ | Max | Min | Typ | Max | | |
| Drain to Source Voltage ¹ | V ⁺ | | | 10.0 | | | 10.0 | V | |
| Initial Threshold Voltage ² | V _{ti} | 0.990 | 1.000 | 1.010 | 0.990 | 1.000 | 1.010 | V | I _{DS} = 1μA T _A = 21°C |
| E-trim V _t Range | V _t | 1.000 | | 3.000 | 1.000 | | 3.000 | V | |
| Drain - Gate Connected Voltage Tempco | TCV _{DS} | | -1.6 -0.3 0.0 +2.7 | | | -1.6 -0.3 0.0 +2.7 | | mV/°C mV/°C mV/°C mV/°C | I _D = 5μA I _D = 50μA I _D = 68μA I _D = 500μA |
| Initial Offset Voltage ³ | V _{OSi} | | 1 | 5 | | 1 | 5 | mV | |
| Tempco of V _{OS} | TCV _{OS} | | 5 | | | 5 | | μV/°C | V _{DS1} = V _{DS2} |
| Differential Threshold Voltage ⁴ | DV _t | | | 2.000 | | | 2.000 | V | |
| Tempco of Differential Threshold Voltage ⁴ | TCDV _t | | 0.033 | | | 0.033 | | mV/°C | |
| Long Term Drift | ΔV _t /Δt | | -0.02 | -0.05 | | -0.02 | -0.05 | mV | 1000 Hours |
| Long Term Drift Match | ΔV _t /Δt | | -5 | | | -5 | | μV | 1000 Hours |
| Drain Source On Current | I _{DS(ON)} | | 3.0 | | | 3.0 | | mA | V _G = V _D = 5V V _S = 0V V _t = 1.0 |
| Drain Source On Current ⁴ | I _{DS(ON)} | | 0.8 | | | 0.8 | | mA | V _G = V _D = 5V V _S = 0V V _t = 3.0 |
| Initial Zero Tempco Voltage ³ | V _{ZTCi} | | 1.52 | | | 1.52 | | V | V _t = 1.000V |
| Zero Tempco Current | I _{ZTC} | | 68 | | | 68 | | μA | |
| Initial On-Resistance ³ | R _{ONi} | | 500 | | | 500 | | Ω | V _{GSj} = 5V V _{DS} = 0.1V |
| On-Resistance Match | ΔR _{ON} | | 0.5 | | | 0.5 | | % | |

NOTES:

1. V⁺ must be the most positive supply rail and V⁻ must be at the most negative supply rail. Source terminals other than those labeled as V⁻ can be at any voltage between V⁻ and V⁺.
2. Initial Threshold Voltage is set at the factory. If no EPAD V_t trimming is intended by user, then this is also the final or permanent threshold voltage value.
3. Initial and Final values are the same unless deliberately changed by user.
4. These parameters apply only when V_t of one or more of the devices are to be changed by user.

OPERATING ELECTRICAL CHARACTERISTICS (cont'd)

T_A = 25°C V₊ = +5.0V unless otherwise specified

| Parameter | Symbol | ALD1121E | | | ALD1123E | | | Unit | Test Conditions |
|---------------------------------------|---------------------|----------|------|----------|----------|------|----------|----------|---|
| | | Min | Typ | Max | Min | Typ | Max | | |
| Transconductance | gm | | 1.4 | | | 1.4 | | mA/V | V _D = 10V, V _G = V _t + 4.0 |
| Transconductance Match | Δgm | | 25 | | | 25 | | μA/V | V _D = 10V, V _G = V _t + 4.0 |
| Low Level Output Conductance | g _{OL} | | 6 | | | 6 | | μA/V | V _G = V _t + 0.5V |
| High Level Output Conductance | g _{OH} | | 68 | | | 68 | | μA/V | V _G = V _t + 4.0V |
| Drain Off Leakage Current | I _{D(OFF)} | | 5 | 400 4 | | 5 | 400 4 | pA nA | T _A = 125°C |
| Gate Leakage Current | I _{GSS} | | 10 | 100 1 | | 10 | 100 1 | pA nA | T _A = 125°C |
| Input Capacitance | C _{ISS} | | 25 | | | 25 | | pF | |
| Cross Talk | | | 60 | | | 60 | | dB | f = 100KHz |
| Relaxation Time Constant ⁴ | t _{RLX} | | 2 | | | 2 | | Hours | |
| Relaxation Voltage ⁴ | V _{RLX} | | -0.3 | | | -0.3 | | % | 1.0V ≤ V _t ≤ 3.0V |

E-TRIM CHARACTERISTICS

T_A = 25°C V₊ = +5.0V unless otherwise specified

| Parameter | Symbol | ALD1121E | | | ALD1123E | | | Unit | Test Conditions |
|--|---------------------|----------|-------------|-------|----------|-------------|-------|-----------|--|
| | | Min | Typ | Max | Min | Typ | Max | | |
| E-trim V _t Range ⁴ | V _t | 1.000 | | 3.000 | 1.000 | | 3.000 | V | |
| Resolution of V _t E-trim Pulse Step ⁴ | RV _t | | 0.1 | 1 | | 0.1 | 1 | mV | |
| Change in V _t Per E-trim Pulse ⁴ | ΔV _t / N | | 0.5 0.05 | | | 0.5 0.05 | | mV/ pulse | V _t = 1.0V V _t = 2.5V |
| E-trim Pulse Voltage ⁴ | V _p | 11.75 | 12.00 | 12.25 | 11.75 | 12.00 | 12.25 | V | |
| E-trim Pulse Current ⁴ | I _p | | 2 | | | 2 | | mA | |
| Pulse Frequency ⁴ | f pulse | | 50 | | | 50 | | KHz | |

TYPICAL PERFORMANCE CHARACTERISTICS

OUTPUT CHARACTERISTICS

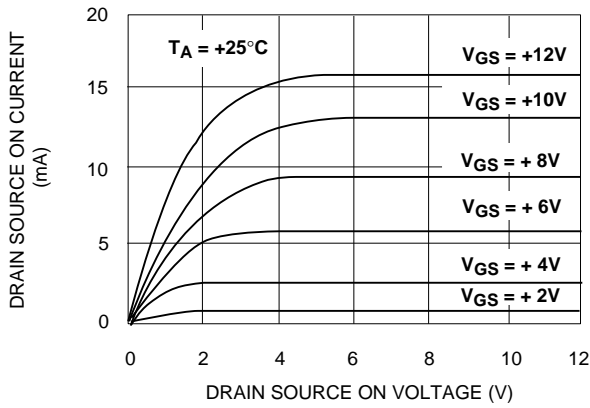

OUTPUT CHARACTERISTICS

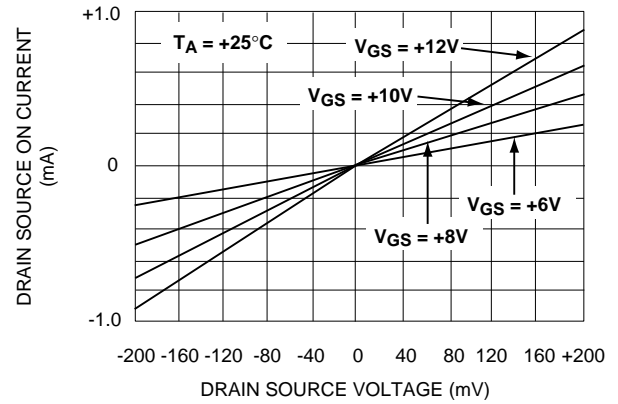

DRAIN SOURCE ON CURRENT vs. AMBIENT TEMPERATURE

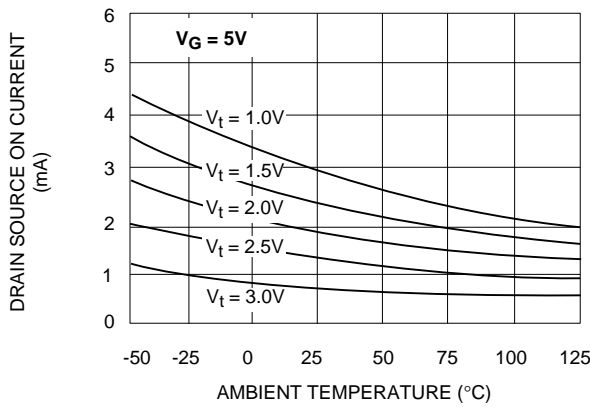

DRAIN SOURCE ON CURRENT vs. THRESHOLD VOLTAGE

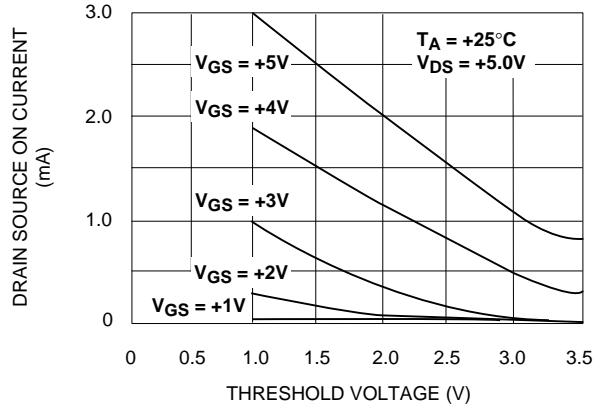

TRANSCONDUCTANCE vs. THRESHOLD VOLTAGE

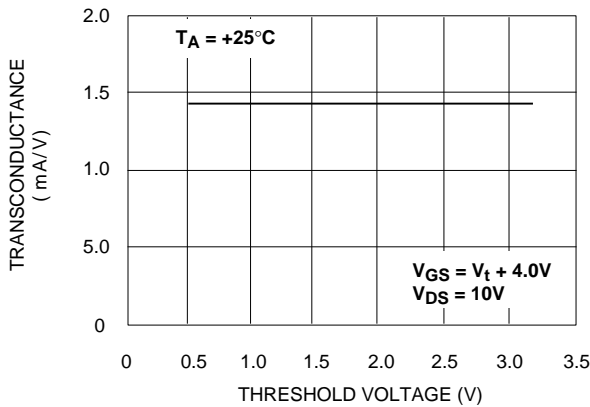

HIGH LEVEL OUTPUT CONDUCTANCE vs. THRESHOLD VOLTAGE

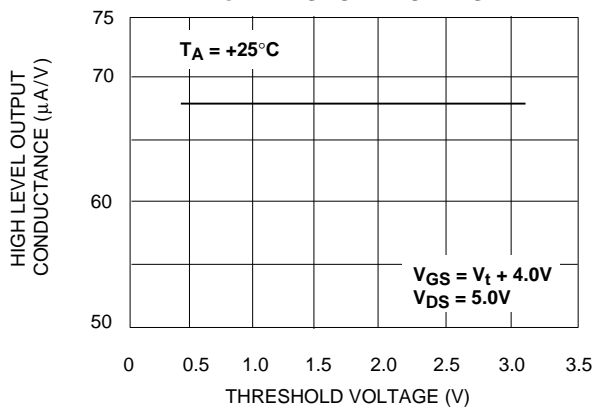

TYPICAL PERFORMANCE CHARACTERISTICS (cont.)

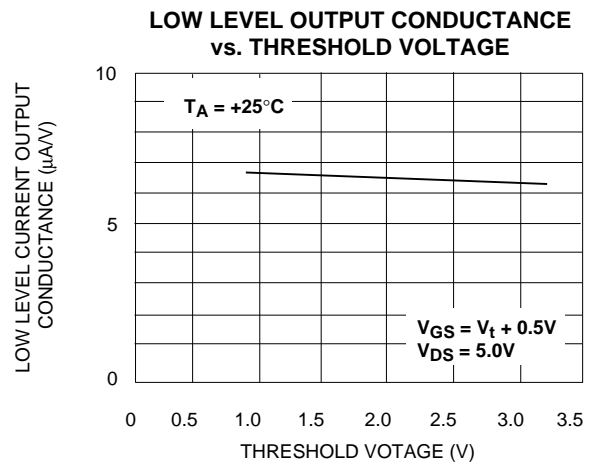
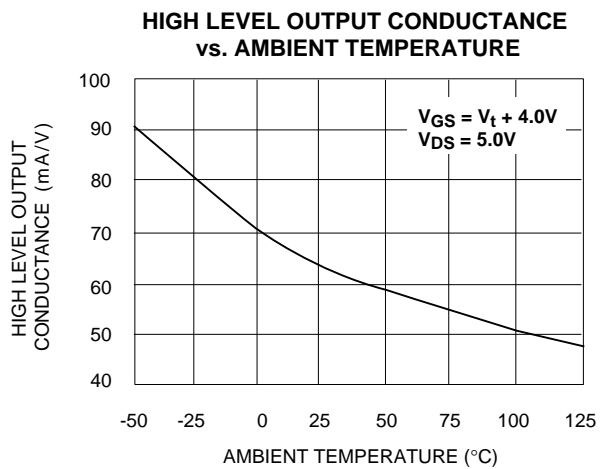
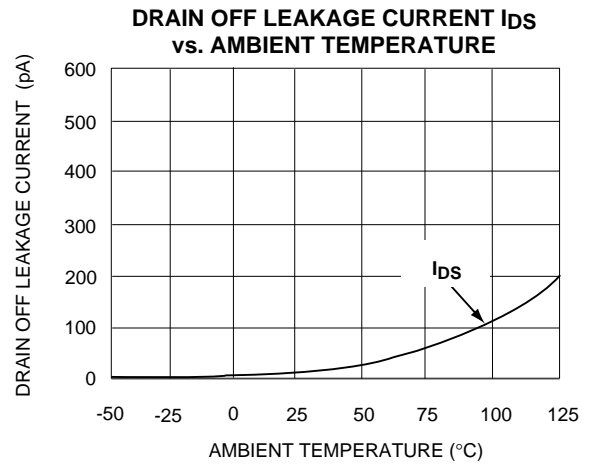
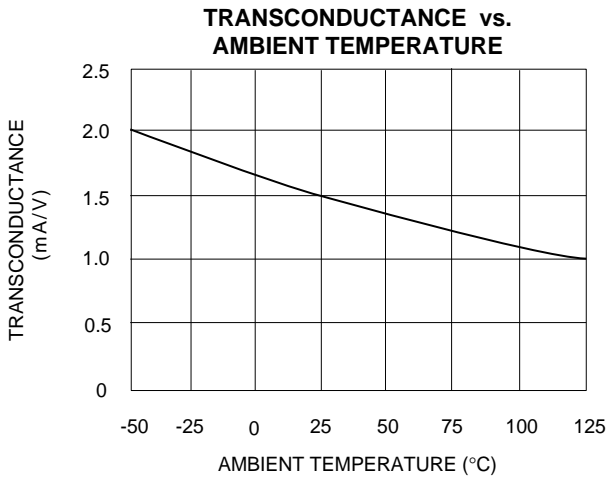
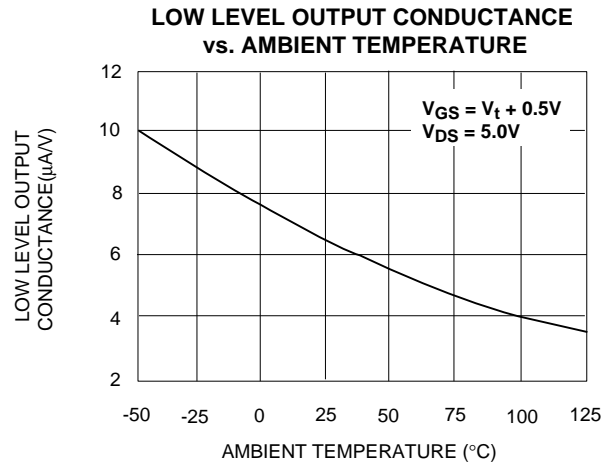
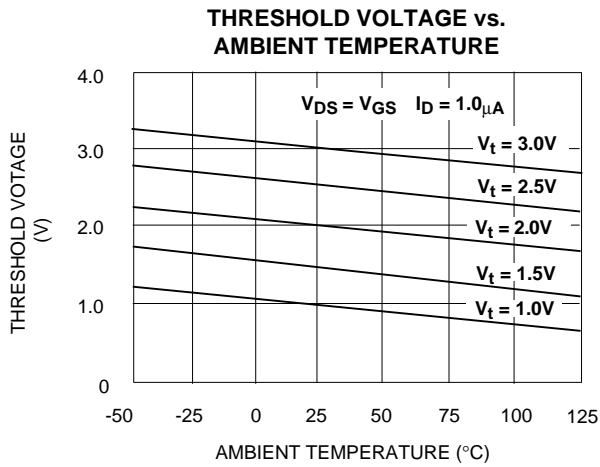

TYPICAL PERFORMANCE CHARACTERISTICS (cont.)

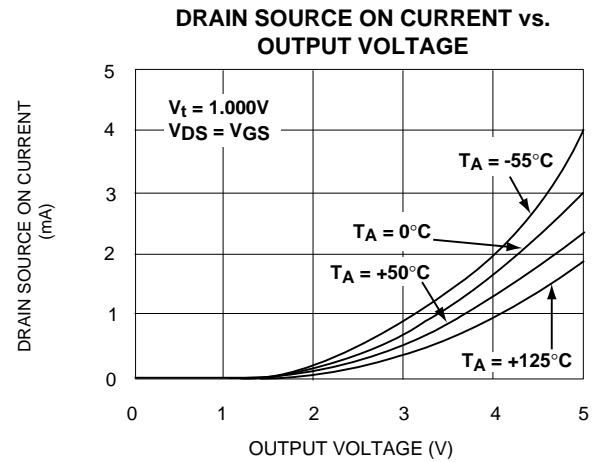
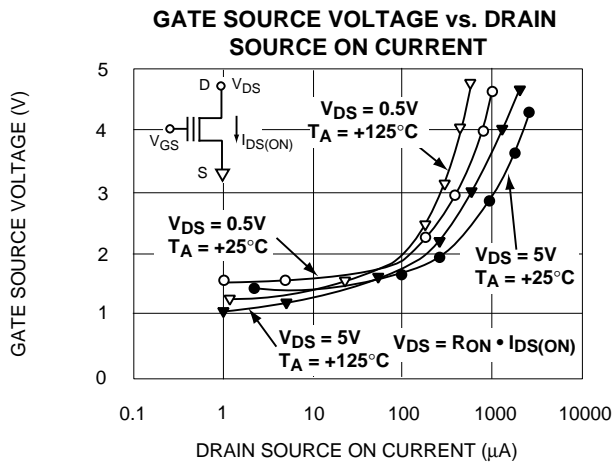
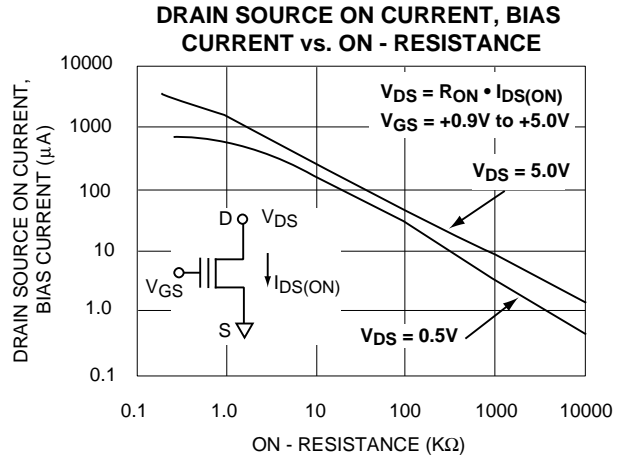
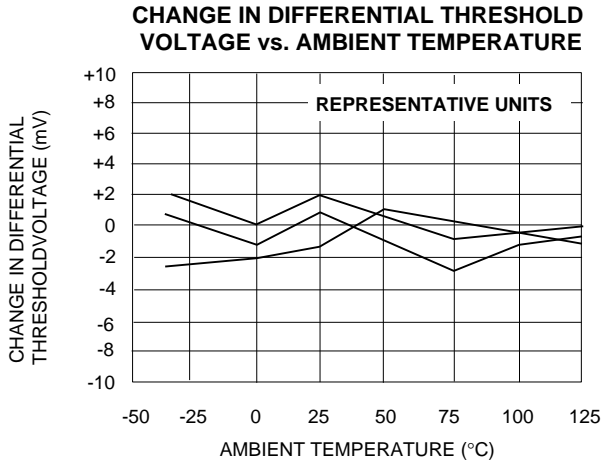
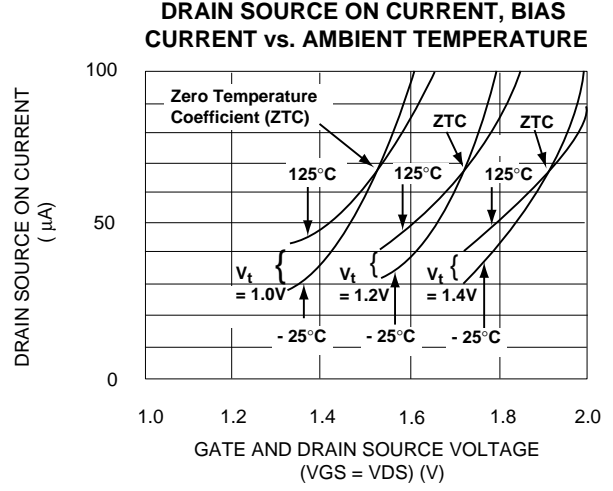
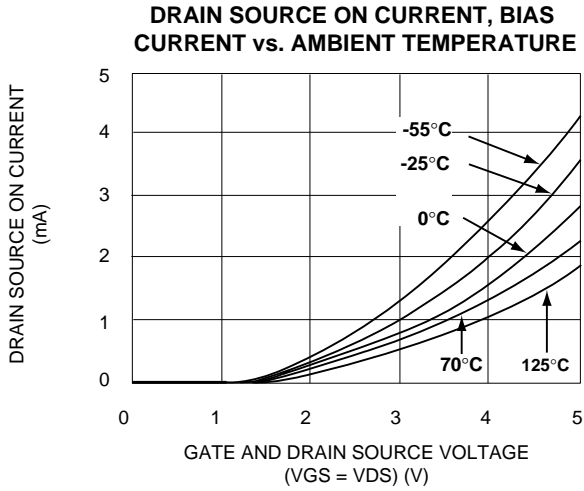

TYPICAL PERFORMANCE CHARACTERISTICS (cont.)

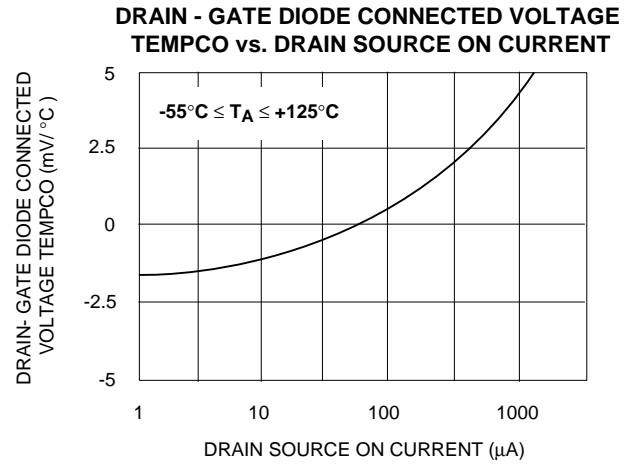
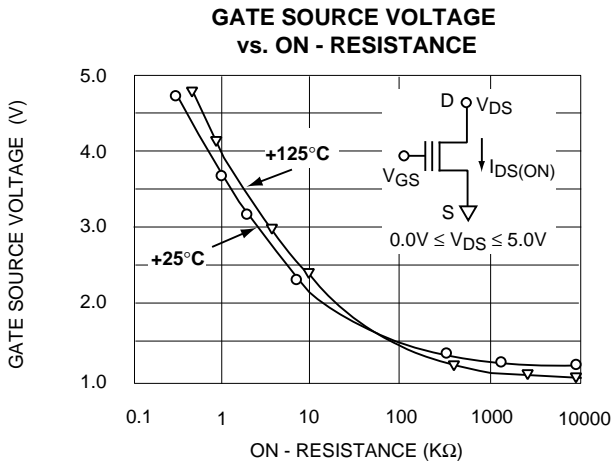
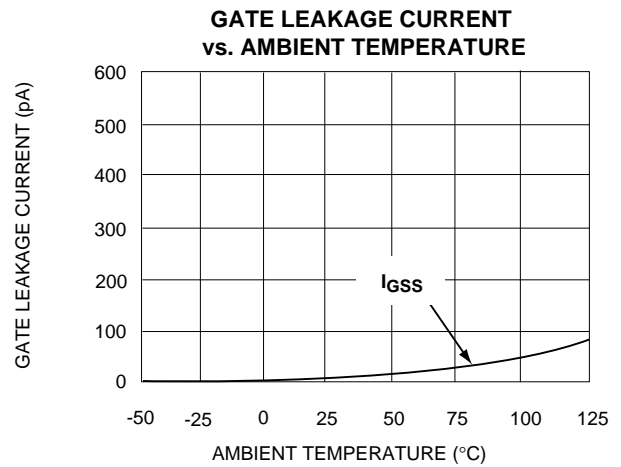
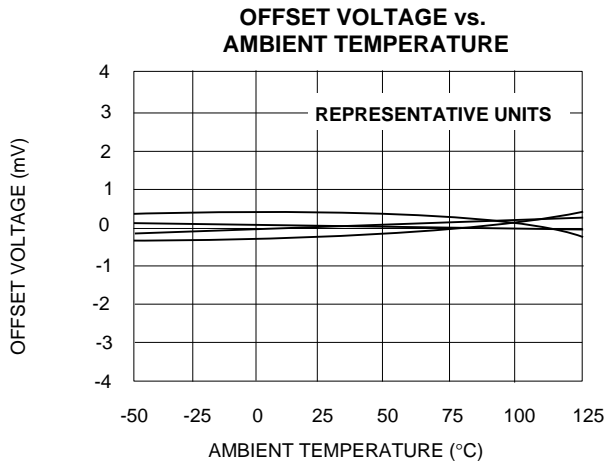

SOIC-8 PACKAGE DRAWING

8 Pin Plastic SOIC Package

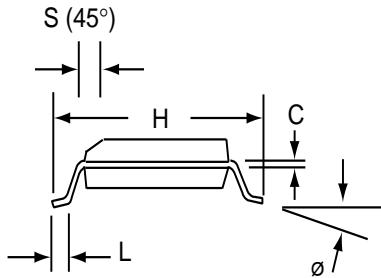
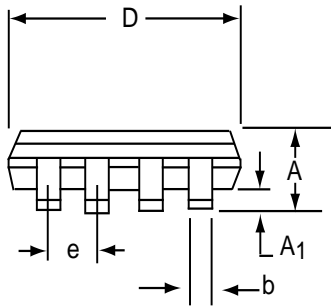
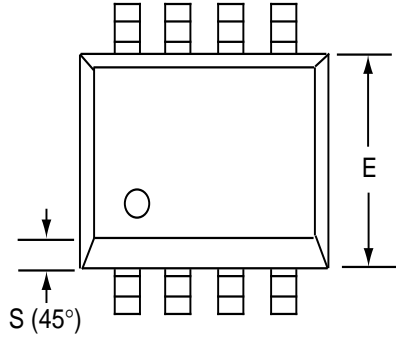

| Dim | Millimeters | | Inches | |
|----------------|-------------|-------|-----------|-------|
| | Min | Max | Min | Max |
| A | 1.35 | 1.75 | 0.053 | 0.069 |
| A ₁ | 0.10 | 0.25 | 0.004 | 0.010 |
| b | 0.35 | 0.45 | 0.014 | 0.018 |
| C | 0.18 | 0.25 | 0.007 | 0.010 |
| D-8 | 4.69 | 5.00 | 0.185 | 0.196 |
| E | 3.50 | 4.05 | 0.140 | 0.160 |
| e | 1.27 BSC | | 0.050 BSC | |
| H | 5.70 | 6.30 | 0.224 | 0.248 |
| L | 0.60 | 0.937 | 0.024 | 0.037 |
| Ø | 0° | 8° | 0° | 8° |
| S | 0.25 | 0.50 | 0.010 | 0.020 |

PDIP-8 PACKAGE DRAWING

8 Pin Plastic DIP Package

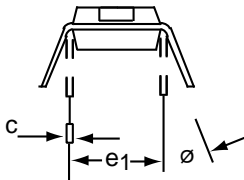
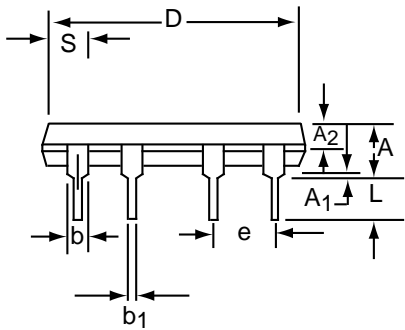
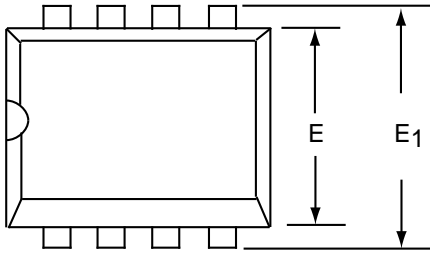

| Dim | Millimeters | | Inches | |
|----------------|-------------|-------|--------|-------|
| | Min | Max | Min | Max |
| A | 3.81 | 5.08 | 0.105 | 0.200 |
| A ₁ | 0.38 | 1.27 | 0.015 | 0.050 |
| A ₂ | 1.27 | 2.03 | 0.050 | 0.080 |
| b | 0.89 | 1.65 | 0.035 | 0.065 |
| b ₁ | 0.38 | 0.51 | 0.015 | 0.020 |
| c | 0.20 | 0.30 | 0.008 | 0.012 |
| D-8 | 9.40 | 11.68 | 0.370 | 0.460 |
| E | 5.59 | 7.11 | 0.220 | 0.280 |
| E ₁ | 7.62 | 8.26 | 0.300 | 0.325 |
| e | 2.29 | 2.79 | 0.090 | 0.110 |
| e ₁ | 7.37 | 7.87 | 0.290 | 0.310 |
| L | 2.79 | 3.81 | 0.110 | 0.150 |
| S-8 | 1.02 | 2.03 | 0.040 | 0.080 |
| ∅ | 0° | 15° | 0° | 15° |

CERDIP-8 PACKAGE DRAWING

8 Pin CERDIP Package

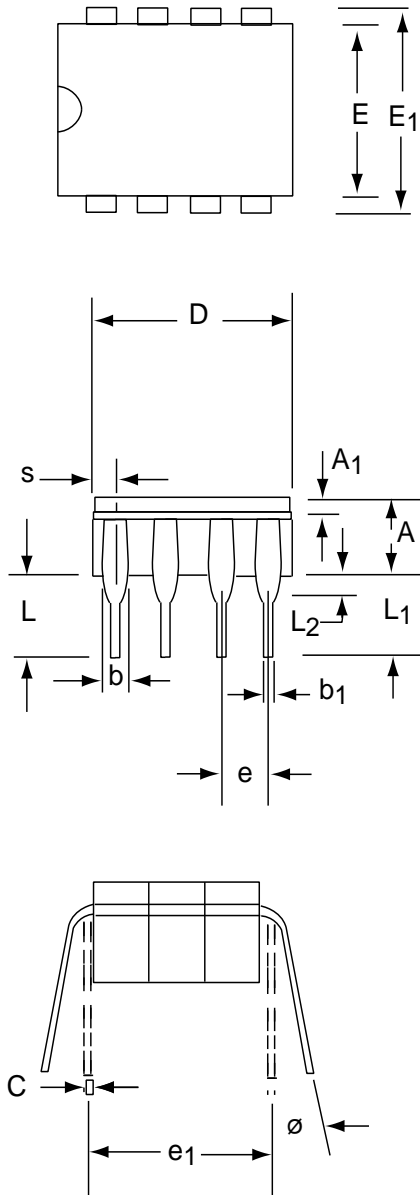

| Dim | Millimeters | | Inches | |
|----------------|-------------|-------|-----------|-------|
| | Min | Max | Min | Max |
| A | 3.55 | 5.08 | 0.140 | 0.200 |
| A ₁ | 1.27 | 2.16 | 0.050 | 0.085 |
| b | 0.97 | 1.65 | 0.038 | 0.065 |
| b ₁ | 0.36 | 0.58 | 0.014 | 0.023 |
| C | 0.20 | 0.38 | 0.008 | 0.015 |
| D-8 | -- | 10.29 | -- | 0.405 |
| E | 5.59 | 7.87 | 0.220 | 0.310 |
| E ₁ | 7.73 | 8.26 | 0.290 | 0.325 |
| e | 2.54 BSC | | 0.100 BSC | |
| e ₁ | 7.62 BSC | | 0.300 BSC | |
| L | 3.81 | 5.08 | 0.150 | 0.200 |
| L ₁ | 3.18 | -- | 0.125 | -- |
| L ₂ | 0.38 | 1.78 | 0.015 | 0.070 |
| S | -- | 2.49 | -- | 0.098 |
| ∅ | 0° | 15° | 0° | 15° |

SOIC-16 PACKAGE DRAWING

16 Pin Plastic SOIC Package

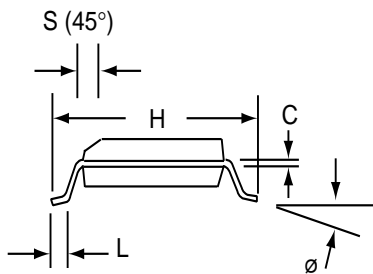
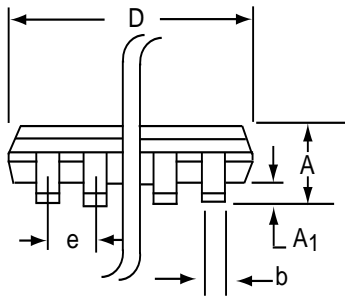
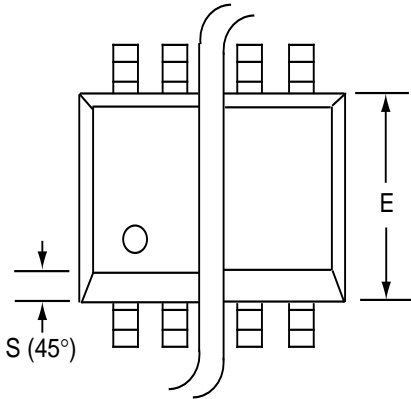

| Dim | Millimeters | | Inches | |
|----------------------|-------------|-------|-----------|-------|
| | Min | Max | Min | Max |
| A | 1.35 | 1.75 | 0.053 | 0.069 |
| A₁ | 0.10 | 0.25 | 0.004 | 0.010 |
| b | 0.35 | 0.45 | 0.014 | 0.018 |
| C | 0.18 | 0.25 | 0.007 | 0.010 |
| D-16 | 9.80 | 10.00 | 0.385 | 0.394 |
| E | 3.50 | 4.05 | 0.140 | 0.160 |
| e | 1.27 BSC | | 0.050 BSC | |
| H | 5.70 | 6.30 | 0.224 | 0.248 |
| L | 0.60 | 0.937 | 0.024 | 0.037 |
| ø | 0° | 8° | 0° | 8° |
| S | 0.25 | 0.50 | 0.010 | 0.020 |

PDIP-16 PACKAGE DRAWING

16 Pin Plastic DIP Package

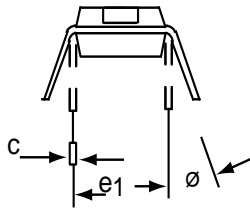
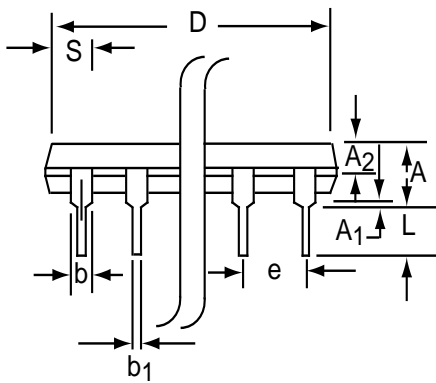
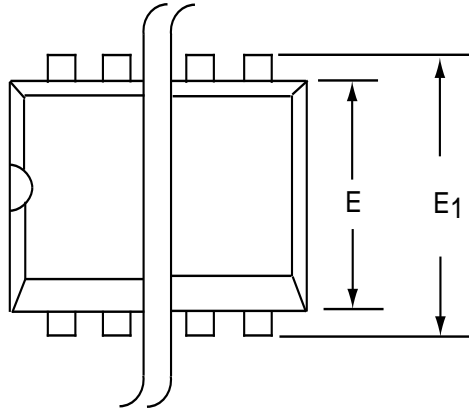

| Dim | Millimeters | | Inches | |
|----------------------|-------------|-------|--------|-------|
| | Min | Max | Min | Max |
| A | 3.81 | 5.08 | 0.105 | 0.200 |
| A₁ | 0.38 | 1.27 | 0.015 | 0.050 |
| A₂ | 1.27 | 2.03 | 0.050 | 0.080 |
| b | 0.89 | 1.65 | 0.035 | 0.065 |
| b₁ | 0.38 | 0.51 | 0.015 | 0.020 |
| c | 0.20 | 0.30 | 0.008 | 0.012 |
| D-16 | 18.93 | 21.33 | 0.745 | 0.840 |
| E | 5.59 | 7.11 | 0.220 | 0.280 |
| E₁ | 7.62 | 8.26 | 0.300 | 0.325 |
| e | 2.29 | 2.79 | 0.090 | 0.110 |
| e₁ | 7.37 | 7.87 | 0.290 | 0.310 |
| L | 2.79 | 3.81 | 0.110 | 0.150 |
| S-16 | 0.38 | 1.52 | 0.015 | 0.060 |
| ∅ | 0° | 15° | 0° | 15° |

CERDIP-16 PACKAGE DRAWING

16 Pin CERDIP Package

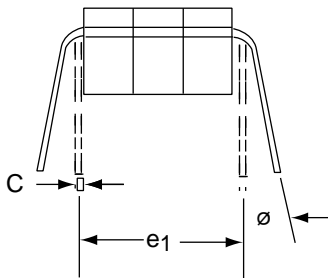
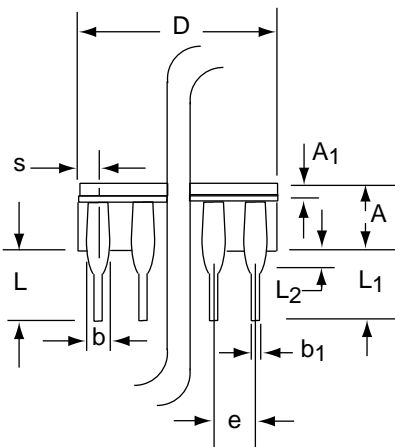
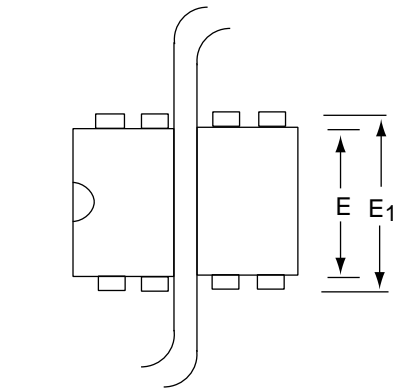

| Dim | Millimeters | | Inches | |
|----------------------|-------------|-------|-----------|-------|
| | Min | Max | Min | Max |
| A | 3.55 | 5.08 | 0.140 | 0.200 |
| A₁ | 1.27 | 2.16 | 0.050 | 0.085 |
| b | 0.97 | 1.65 | 0.038 | 0.065 |
| b₁ | 0.36 | 0.58 | 0.014 | 0.023 |
| C | 0.20 | 0.38 | 0.008 | 0.015 |
| D-16 | -- | 21.34 | -- | 0.840 |
| E | 5.59 | 7.87 | 0.220 | 0.310 |
| E₁ | 7.73 | 8.26 | 0.290 | 0.325 |
| e | 2.54 BSC | | 0.100 BSC | |
| e₁ | 7.62 BSC | | 0.300 BSC | |
| L | 3.81 | 5.08 | 0.150 | 0.200 |
| L₁ | 3.18 | -- | 0.125 | -- |
| L₂ | 0.38 | 1.78 | 0.015 | 0.070 |
| S | -- | 2.49 | -- | 0.098 |
| Ø | 0° | 15° | 0° | 15° |