

**PLEASE CHECK WWW.MOLEX.COM FOR LATEST PART INFORMATION**

**Part Number:** [0459841171](#)  
**Status:** **Active**  
**Overview:** [extreme\\_lphpower](#)  
**Description:** 1.27mm (.050"), 12.00mm (.472") Pitch, EXTreme LPHPower™ Receptacle Header, Right Angle, 10 Power Contacts, 36 Signal Contacts, Select Gold (Au) Plating, for 3.18mm (.125") Thick PC Board

**Documents:**

[3D Model](#) [Product Specification PS-45984-001 \(PDF\)](#)  
[Drawing \(PDF\)](#) [RoHS Certificate of Compliance \(PDF\)](#)

**Agency Certification**

CSA LR 19980  
 UL E29179

**General**

Product Family PCB Receptacles  
 Series [45984](#)  
 Application Board-to-Board  
 Overview [extreme\\_lphpower](#)  
 Product Name EXTreme LPHPower™

**Physical**

Circuits (Loaded) 46  
 Circuits (maximum) 46  
 Circuits Detail 10 Power, 36 Signal  
 Color - Resin Black  
 Durability (mating cycles max) 250  
 Flammability 94V-0  
 Glow-Wire Compliant No  
 Guide to Mating Part No  
 Keying to Mating Part Yes  
 Lock to Mating Part No  
 Material - Metal High Performance Alloy (HPA), Phosphor Bronze  
 Material - Plating Mating Gold  
 Material - Plating Termination Tin  
 Material - Resin High Temperature Thermoplastic  
 Number of Rows 2  
 Orientation Right Angle  
 PC Tail Length (in) 0.177 In  
 PC Tail Length (mm) 4.50 mm  
 PCB Locator No  
 PCB Retention None  
 PCB Thickness Recommended (in) 0.125 In  
 PCB Thickness Recommended (mm) 3.18 mm  
 Packaging Type Tray  
 Pitch - Mating Interface (in) 0.050 In, 0.472 In  
 Pitch - Mating Interface (mm) 1.27 mm, 12.00 mm  
 Plating min: Mating (µin) 30  
 Plating min: Mating (µm) 0.75  
 Plating min: Termination (µin) 150, 75  
 Plating min: Termination (µm) 1.875, 3.75  
 Polarized to Mating Part Yes  
 Polarized to PCB Yes  
 Stackable No  
 Surface Mount Compatible (SMC) Yes

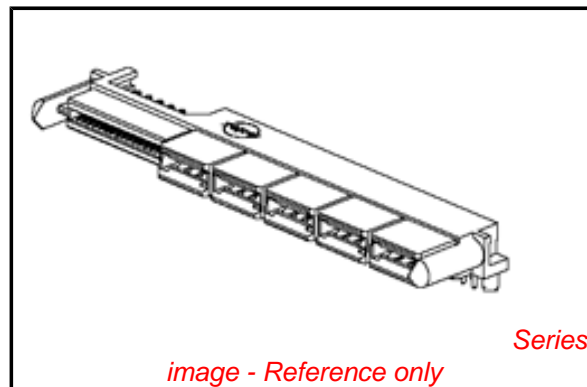

**EU RoHS**

**ELV and RoHS Compliant**  
**REACH SVHC Contains SVHC: No**  
**Halogen-Free Status**

**China RoHS**



**Need more information on product environmental compliance?**

Email [productcompliance@molex.com](mailto:productcompliance@molex.com)  
 For a multiple part number RoHS Certificate of Compliance, [click here](#)

Please visit the [Contact Us](#) section for any non-product compliance questions.

**Search Parts in this Series**

[45984Series](#)

**Mates With**

[45985](#) EXTreme LPHPower™ Headers, 1.57mm (.062") Card Edge

Temperature Range - Operating -40°C to +105°C  
Termination Interface: Style Through Hole

### **Electrical**

Current - Maximum per Contact 20A  
Grounding to PCB No  
Voltage - Maximum 250V AC (RMS)/DC

### **Solder Process Data**

Duration at Max. Process Temperature (seconds) 20  
Lead-free Process Capability Wave Capable (TH only)  
Max. Cycles at Max. Process Temperature 3  
Process Temperature max. C 260

### **Material Info**

#### **Reference - Drawing Numbers**

Packaging Specification PK-45984-001  
Product Specification PS-45984-001  
Sales Drawing SD-45984-100

This document was generated on 05/21/2010

**PLEASE CHECK [WWW.MOLEX.COM](http://WWW.MOLEX.COM) FOR LATEST PART INFORMATION**



NOTES:

1. MATERIAL HOUSING: LCP, 94V-0, COLOR-BLACK.  
CONTACT: COPPER ALLOY.
2. FINISH: SELECT GOLD - .76  $\mu$ M/30 MI MIN. CONTACT.  
SELECT TIN - 3.81  $\mu$ M/150 MI MIN. TAIL.  
BOTH OVER NICKEL - 1.27  $\mu$ M/50 MI MIN.
3. POWER TERMINALS LUBRICATED IN CONTACT AREA.
4. PRODUCT SPECIFICATION: PS-45984-001.
5. PACKAGING: TRAY PER PK-45984-001.
6. SEE SHEET 5 FOR CKT IDENTIFICATION.
7. PARTS ARE RoHS COMPLIANT.
8. PEG HOLES ARE OPTIONAL
9. MATES TO 1571,062 CARD EDGE OR  
MOLEX P/N 45985-1\*\*\*

| NO OF SIGNAL | MATERIAL NUMBER | DIM A | DIM P | PCB THK |
|--------------|-----------------|-------|-------|---------|
| 12           | 45984-1111      | 71.5  | 4.50  | 3.18    |
| 16           | 45984-1121      | 74.0  |       |         |
| 20           | 45984-1131      | 76.6  |       |         |
| 24           | 45984-1141      | 79.1  |       |         |
| 28           | 45984-1151      | 81.6  |       |         |
| 32           | 45984-1161      | 84.2  | 3.60  | 2.36    |
| 36           | 45984-1171      | 86.7  |       |         |
| 40           | 45984-1181      | 89.3  |       |         |
| 12           | 45984-1112      | 71.5  |       |         |
| 16           | 45984-1122      | 74.0  |       |         |
| 20           | 45984-1132      | 76.6  | 2.90  | 1.57    |
| 24           | 45984-1142      | 79.1  |       |         |
| 28           | 45984-1152      | 81.6  |       |         |
| 32           | 45984-1162      | 84.2  |       |         |
| 36           | 45984-1172      | 86.7  |       |         |
| 40           | 45984-1182      | 89.3  | 2.90  | 1.57    |
| 12           | 45984-1113      | 71.5  |       |         |
| 16           | 45984-1123      | 74.0  |       |         |
| 20           | 45984-1133      | 76.6  |       |         |
| 24           | 45984-1143      | 79.1  |       |         |
| 28           | 45984-1153      | 81.6  |       |         |
| 32           | 45984-1163      | 84.2  |       |         |
| 36           | 45984-1173      | 86.7  |       |         |
| 40           | 45984-1183      | 89.3  |       |         |

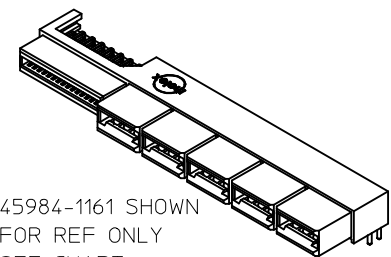

45984-1161 SHOWN FOR REF ONLY SEE CHART

|                          |             |
|--------------------------|-------------|
| REVISED                  | DESCRIPTION |
| EC NO: UCP2009-0971      |             |
| DRWN:MBANDURA 2008/11/13 |             |
| CHKD: 2008/11/14         |             |
| APPR:APATEL 2008/11/17   |             |
| REV                      |             |

|  |                      |
|--|----------------------|
| GENERAL TOLERANCES (UNLESS SPECIFIED)                |                      |
|  | mm INCH              |
| 4 PLACES   | $\pm$ --- $\pm$ ---  |
| 3 PLACES   | $\pm$ --- $\pm$ ---  |
| 2 PLACES   | $\pm$ 0.25 $\pm$ --- |
| 1 PLACE  | $\pm$ --- $\pm$ ---  |
| ANGULAR $\pm$ 1/2°                                   |                      |
| DRAFT WHERE APPLICABLE MUST REMAIN WITHIN DIMENSIONS |                      |

|                 |            |
|-----------------|------------|
| DIMENSION STYLE |            |
| MM ONLY         |            |
| DRAWN BY        | DATE       |
| SAMIEC          | 2005/05/13 |
| CHECKED BY      | DATE       |
| SAMIEC          | 2005/05/13 |
| APPROVED BY     | DATE       |
| MARGULIS        | 2005/05/13 |
| MATERIAL NO.    | SEE CHART  |
| SIZE            | A          |

|   |              |                        |
|---|--------------|------------------------|
| SCALE   | DESIGN UNITS | THIRD ANGLE PROJECTION |
| 1:1   | METRIC       |                        |
| TITLE   |              |                        |
| LPH RECEPTACLE ASSEMBLY<br>RT ANGLE 10 CIRCUIT<br>POWER CONNECTOR   |              |                        |
| MOLEX MOLEX INCORPORATED  |              |                        |
| DOCUMENT NO.  | SHEET NO.    |                        |
| SD-45984-100  | 1 OF 5       |                        |
| THIS DRAWING CONTAINS INFORMATION THAT IS PROPRIETARY TO MOLEX INCORPORATED AND SHOULD NOT BE USED WITHOUT WRITTEN PERMISSION |              |                        |

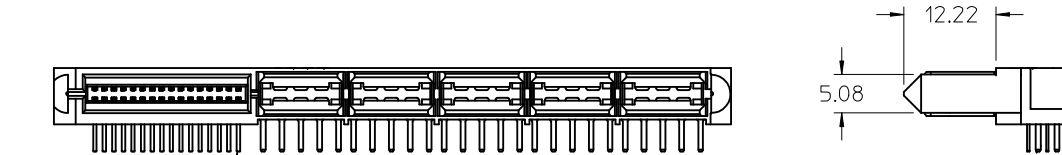
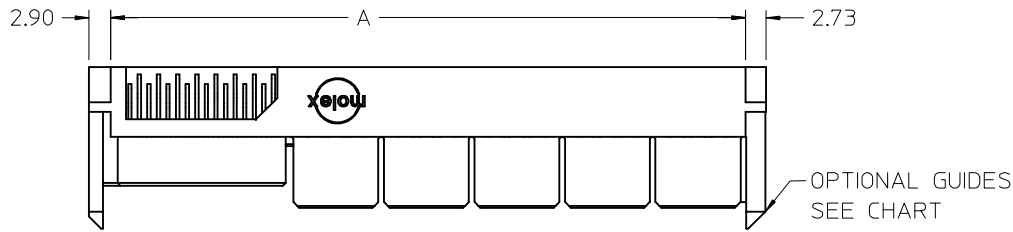

NO OF SIGNALS  
OPTIONAL  
SEE CHART

GUIDE POST OPTIONS

| NO OF SIGNAL | MATERIAL NUMBER | DIM A | DIM P | PCB THK |
|--------------|-----------------|-------|-------|---------|
| 12           | 45984-1211      | 71.5  | 4.50  | 3.18    |
| 16           | 45984-1221      | 74.0  |       |         |
| 20           | 45984-1231      | 76.6  |       |         |
| 24           | 45984-1241      | 79.1  |       |         |
| 28           | 45984-1251      | 81.6  |       |         |
| 32           | 45984-1261      | 84.2  |       |         |
| 36           | 45984-1271      | 86.7  | 3.60  | 2.36    |
| 40           | 45984-1281      | 89.3  |       |         |
| 12           | 45984-1212      | 71.5  |       |         |
| 16           | 45984-1222      | 74.0  |       |         |
| 20           | 45984-1232      | 76.6  |       |         |
| 24           | 45984-1242      | 79.1  |       |         |
| 28           | 45984-1252      | 81.6  | 2.90  | 1.57    |
| 32           | 45984-1262      | 84.2  |       |         |
| 36           | 45984-1272      | 86.7  |       |         |
| 40           | 45984-1282      | 89.3  |       |         |
| 12           | 45984-1213      | 71.5  |       |         |
| 16           | 45984-1223      | 74.0  |       |         |
| 20           | 45984-1233      | 76.6  |       |         |
| 24           | 45984-1243      | 79.1  |       |         |
| 28           | 45984-1253      | 81.6  |       |         |
| 32           | 45984-1263      | 84.2  |       |         |
| 36           | 45984-1273      | 86.7  |       |         |
| 40           | 45984-1283      | 89.3  |       |         |

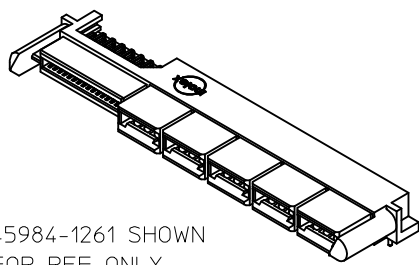

45984-1261 SHOWN  
FOR REF ONLY  
SEE CHART

|  |                                       |       |                            |                         |   |  |                        |  |  |
|--|---------------------------------------|-------|----------------------------|-------------------------|---|--|------------------------|--|--|
| REVISED<br>EC NO: UCP2009-0971<br>DRWN:MBANDURA 2008/11/13<br>CHKD: 2008/11/14<br>APPR:APATEL 2008/11/17<br>DESCRIPTION<br>REV | GENERAL TOLERANCES (UNLESS SPECIFIED) |       | DIMENSION STYLE<br>MM ONLY |                         | SCALE<br>1:1  | DESIGN UNITS<br>METRIC   | THIRD ANGLE PROJECTION |  |  |
|  |                                       | mm    | INCH                       | DRAWN BY<br>SAMIEC      | DATE<br>2005/05/13  | TITLE<br>LPH RECEPTACLE ASSEMBLY<br>RT ANGLE 10 CIRCUIT<br>POWER CONNECTOR |                        |  |  |
|  | 4 PLACES                              | ± --- | ± ---                      | CHECKED BY<br>SAMIEC    | DATE<br>2005/05/13  |  |                        |  |  |
|  | 3 PLACES                              | ± --- | ± ---                      | APPROVED BY<br>MARGULIS | DATE<br>2005/05/13  | MOLEX INCORPORATED<br>DOCUMENT NO.<br>SD-45984-100                         |                        |  |  |
| 2 PLACES   | ± 0.25                                | ± --- | MATERIAL NO.<br>SEE CHART  |                         | SHEET NO.<br>2 OF 5   |  |                        |  |  |
| 1 PLACE  | ± ---                                 | ± --- | ANGULAR ±1/2°              |                         | THIS DRAWING CONTAINS INFORMATION THAT IS PROPRIETARY TO MOLEX INCORPORATED AND SHOULD NOT BE USED WITHOUT WRITTEN PERMISSION |  |                        |  |  |
| DRAFT WHERE APPLICABLE MUST REMAIN WITHIN DIMENSIONS   |                                       |       |                            |                         |   |  |                        |  |  |

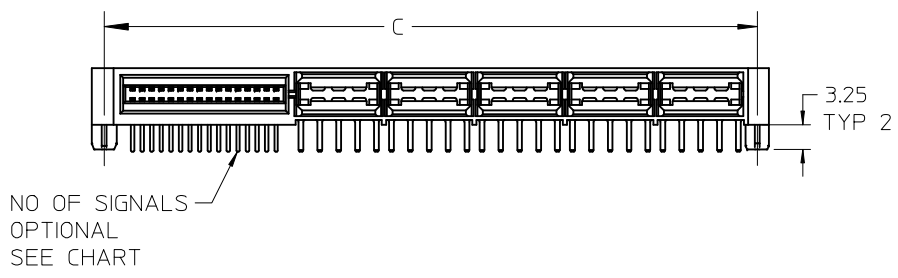

MOUNTING PEG OPTIONS

| NO OF SIGNAL | MATERIAL NUMBER | DIM A | DIM C | DIM P | PCB THK |
|--------------|-----------------|-------|-------|-------|---------|
| 12           | 45984-1311      | 71.5  | 73.90 | 4.50  | 3.18    |
| 16           | 45984-1321      | 74.0  | 76.44 |       |         |
| 20           | 45984-1331      | 76.6  | 78.98 |       |         |
| 24           | 45984-1341      | 79.1  | 81.52 |       |         |
| 28           | 45984-1351      | 81.6  | 84.06 |       |         |
| 32           | 45984-1361      | 84.2  | 86.60 |       |         |
| 36           | 45984-1371      | 86.7  | 89.14 | 3.60  | 2.36    |
| 40           | 45984-1381      | 89.3  | 91.68 |       |         |
| 12           | 45984-1312      | 71.5  | 73.90 |       |         |
| 16           | 45984-1322      | 74.0  | 76.44 |       |         |
| 20           | 45984-1332      | 76.6  | 78.98 |       |         |
| 24           | 45984-1342      | 79.1  | 81.52 |       |         |
| 28           | 45984-1352      | 81.6  | 84.06 | 2.90  | 1.57    |
| 32           | 45984-1362      | 84.2  | 86.60 |       |         |
| 36           | 45984-1372      | 86.7  | 89.14 |       |         |
| 40           | 45984-1382      | 89.3  | 91.68 |       |         |
| 12           | 45984-1313      | 71.5  | 73.90 |       |         |
| 16           | 45984-1323      | 74.0  | 76.44 |       |         |
| 20           | 45984-1333      | 76.6  | 78.98 |       |         |
| 24           | 45984-1343      | 79.1  | 81.52 |       |         |
| 28           | 45984-1353      | 81.6  | 84.06 |       |         |
| 32           | 45984-1363      | 84.2  | 86.60 |       |         |
| 36           | 45984-1373      | 86.7  | 89.14 |       |         |
| 40           | 45984-1383      | 89.3  | 91.68 |       |         |

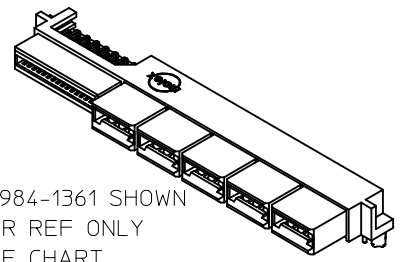

45984-1361 SHOWN FOR REF ONLY SEE CHART

|               |                     |            |
|---------------|---------------------|------------|
| REVISED       | EC NO: UCP2009-0971 | 2008/11/13 |
| DRWN:MBANDURA | 2008/11/14          |            |
| CHKD:         | 2008/11/14          |            |
| APPR:APATEL   | 2008/11/17          |            |
| REV           | DESCRIPTION         |            |

|  |        |       |
|--|--------|-------|
| GENERAL TOLERANCES (UNLESS SPECIFIED)                |        |       |
|  | mm     | INCH  |
| 4 PLACES   | ± ---  | ± --- |
| 3 PLACES   | ± ---  | ± --- |
| 2 PLACES   | ± 0.25 | ± --- |
| 1 PLACE  | ± ---  | ± --- |
| ANGULAR ±1/2°  |        |       |
| DRAFT WHERE APPLICABLE MUST REMAIN WITHIN DIMENSIONS |        |       |

|                 |            |
|-----------------|------------|
| DIMENSION STYLE |            |
| MM ONLY         |            |
| DRAWN BY        | DATE       |
| SAMIEC          | 2005/05/13 |
| CHECKED BY      | DATE       |
| SAMIEC          | 2005/05/13 |
| APPROVED BY     | DATE       |
| MARGULIS        | 2005/05/13 |
| MATERIAL NO.    |            |
| SEE CHART       |            |

|   |              |                        |
|---|--------------|------------------------|
| SCALE   | DESIGN UNITS | THIRD ANGLE PROJECTION |
| 1:1   | METRIC       |                        |
| TITLE   |              |                        |
| LPH RECEPTACLE ASSEMBLY<br>RT ANGLE 10 CIRCUIT<br>POWER CONNECTOR   |              |                        |
| MOLEX INCORPORATED  |              |                        |
| DOCUMENT NO.  | SHEET NO.    |                        |
| SD-45984-100  | 3 OF 5       |                        |
| THIS DRAWING CONTAINS INFORMATION THAT IS PROPRIETARY TO MOLEX INCORPORATED AND SHOULD NOT BE USED WITHOUT WRITTEN PERMISSION |              |                        |



NO OF SIGNALS  
OPTIONAL  
SEE CHART

### GUIDE POST & MOUNTING PEG OPTIONS

| NO OF SIGNAL | MATERIAL NUMBER | DIM A | DIM C | DIM P | PCB THK |
|--------------|-----------------|-------|-------|-------|---------|
| 12           | 45984-1411      | 71.5  | 73.90 | 4.50  | 3.18    |
| 16           | 45984-1421      | 74.0  | 76.44 |       |         |
| 20           | 45984-1431      | 76.6  | 78.98 |       |         |
| 24           | 45984-1441      | 79.1  | 81.52 |       |         |
| 28           | 45984-1451      | 81.6  | 84.06 |       |         |
| 32           | 45984-1461      | 84.2  | 86.60 |       |         |
| 36           | 45984-1471      | 86.7  | 89.14 | 3.60  | 2.36    |
| 40           | 45984-1481      | 89.3  | 91.68 |       |         |
| 12           | 45984-1412      | 71.5  | 73.90 |       |         |
| 16           | 45984-1422      | 74.0  | 76.44 |       |         |
| 20           | 45984-1432      | 76.6  | 78.98 |       |         |
| 24           | 45984-1442      | 79.1  | 81.52 |       |         |
| 28           | 45984-1452      | 81.6  | 84.06 | 2.90  | 1.57    |
| 32           | 45984-1462      | 84.2  | 86.60 |       |         |
| 36           | 45984-1472      | 86.7  | 89.14 |       |         |
| 40           | 45984-1482      | 89.3  | 91.68 |       |         |
| 12           | 45984-1413      | 71.5  | 73.90 |       |         |
| 16           | 45984-1423      | 74.0  | 76.44 |       |         |
| 20           | 45984-1433      | 76.6  | 78.98 |       |         |
| 24           | 45984-1443      | 79.1  | 81.52 |       |         |
| 28           | 45984-1453      | 81.6  | 84.06 |       |         |
| 32           | 45984-1463      | 84.2  | 86.60 |       |         |
| 36           | 45984-1473      | 86.7  | 89.14 |       |         |
| 40           | 45984-1483      | 89.3  | 91.68 |       |         |

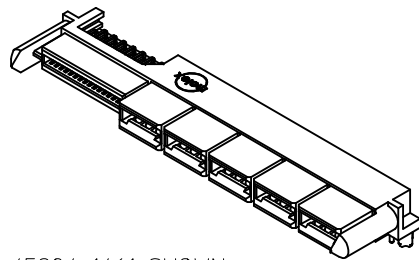

45984-1461 SHOWN  
FOR REF ONLY  
SEE CHART

|  |  |       |                                   |  |                                     |   |                            |  |  |
|--|--|-------|-----------------------------------|--|-------------------------------------|---|----------------------------|--|--|
| REVISED<br>EC NO: UCP2009-0971<br>DRWN:MBANDURA 2008/11/13<br>CHKD: 2008/11/14<br>APPR:APATEL 2008/11/17<br>DESCRIPTION<br>REV | GENERAL TOLERANCES<br>(UNLESS SPECIFIED)                   |       | DIMENSION STYLE<br><b>MM ONLY</b> |  | SCALE<br><b>1:1</b>                 | DESIGN UNITS<br><b>METRIC</b>   | THIRD ANGLE<br>PROJECTION  |  |  |
|  |  | mm    | INCH                              | DRAWN BY   | DATE                                | TITLE<br><b>LPH RECEPTACLE ASSEMBLY<br/>         RT ANGLE 10 CIRCUIT<br/>         POWER CONNECTOR</b> |                            |  |  |
|  | 4 PLACES   | ± --- | ± ---                             | SAMIEC   | 2005/05/13                          |   |                            |  |  |
|  | 3 PLACES   | ± --- | ± ---                             | CHECKED BY   | DATE                                | MOLEX INCORPORATED  |                            |  |  |
| 2 PLACES   | ± 0.25   | ± --- | SAMIEC                            | 2005/05/13   |                                     |   |                            |  |  |
| 1 PLACE  | ± ---  | ± --- | APPROVED BY                       | DATE   | DOCUMENT NO.<br><b>SD-45984-100</b> |   | SHEET NO.<br><b>4 OF 5</b> |  |  |
|  | ANGULAR ±1/2°  |       | MATERIAL NO.                      |  | SEE CHART                           |   |                            |  |  |
|  | DRAFT WHERE APPLICABLE<br>MUST REMAIN<br>WITHIN DIMENSIONS |       | SIZE                              | THIS DRAWING CONTAINS INFORMATION THAT IS PROPRIETARY TO MOLEX<br>INCORPORATED AND SHOULD NOT BE USED WITHOUT WRITTEN PERMISSION |                                     |   |                            |  |  |
|  |  |       | A                                 |  |                                     |   |                            |  |  |

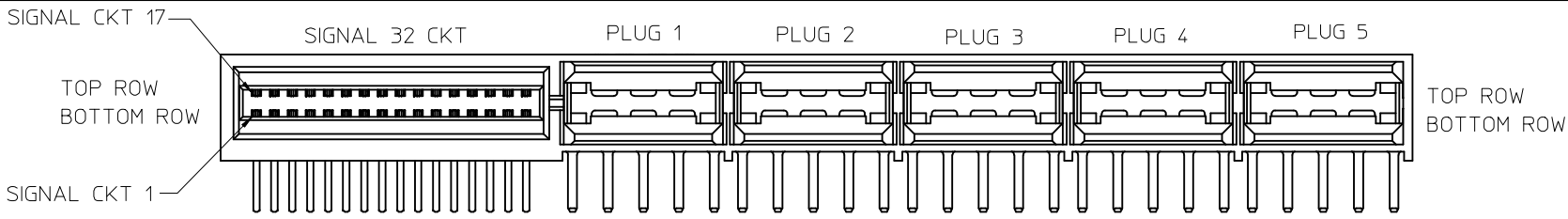

| NO. OF SIGNAL | DIM. D |
|---------------|--------|
| 12            | 8.00   |
| 16            | 10.54  |
| 20            | 13.08  |
| 24            | 15.62  |
| 28            | 18.16  |
| 32            | 20.70  |
| 36            | 23.24  |
| 40            | 25.78  |



RECOMMENDED  
EDGE CARD LAYOUT  
THICKNESS: 1.57/0.62

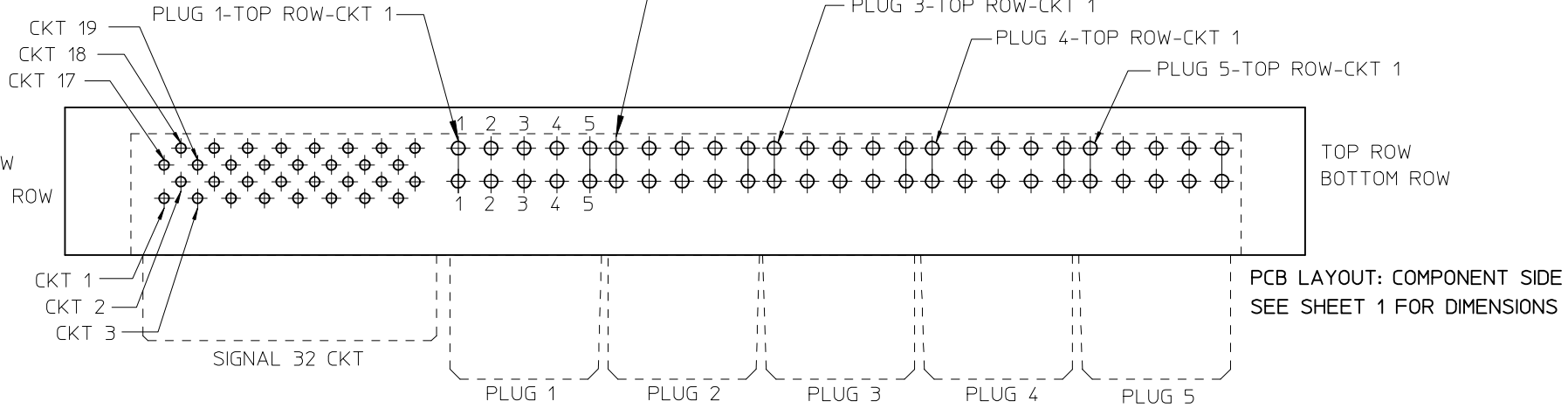

PCB LAYOUT: COMPONENT SIDE  
SEE SHEET 1 FOR DIMENSIONS

| REVISED  | REV | DESCRIPTION |
|--|-----|-------------|
| EC NO: UCP2009-0971<br>DRWN: MBANDURA<br>CHKD:<br>APPR: APATEL |     |             |
| 2008/11/13<br>2008/11/14<br>2008/11/17                         |     |             |

| GENERAL TOLERANCES (UNLESS SPECIFIED)                      |        |       |
|--|--------|-------|
|  | mm     | INCH  |
| 4 PLACES   | ± ---  | ± --- |
| 3 PLACES   | ± ---  | ± --- |
| 2 PLACES   | ± 0.25 | ± --- |
| 1 PLACE  | ± ---  | ± --- |
| ANGULAR ± 1/2°   |        |       |
| DRAFT WHERE APPLICABLE<br>MUST REMAIN<br>WITHIN DIMENSIONS |        |       |

| DIMENSION STYLE |            |
|-----------------|------------|
| MM ONLY         |            |
| DRAWN BY        | DATE       |
| SAMIEC          | 2005/05/13 |
| CHECKED BY      | DATE       |
| SAMIEC          | 2005/05/13 |
| APPROVED BY     | DATE       |
| MARGULIS        | 2005/05/13 |
| MATERIAL NO.    |            |

|   |              |                        |           |
|---|--------------|------------------------|-----------|
| SCALE   | DESIGN UNITS | THIRD ANGLE PROJECTION |           |
| 2:1   | METRIC       |                        |           |
| TITLE   |              |                        |           |
| LPH RECEPTACLE ASSEMBLY<br>RT ANGLE 10 CIRCUIT<br>POWER CONNECTOR   |              |                        |           |
| MOLEX INCORPORATED  |              |                        |           |
| DOCUMENT NO.  |              |                        | SHEET NO. |
| SD-45984-100  |              |                        | 5 OF 5    |
| THIS DRAWING CONTAINS INFORMATION THAT IS PROPRIETARY TO MOLEX INCORPORATED AND SHOULD NOT BE USED WITHOUT WRITTEN PERMISSION |              |                        |           |