

# M54566DP

7-UNIT 400mA DARLINGTON TRANSISTOR ARRAY

## DESCRIPTION

M54566DP is seven-circuit collector current sink type darlington transistor arrays. The circuits are made of PNP and NPN transistors. Both the semiconductor integrated circuits perform high-current driving with extremely low input-current supply.

## FEATURES

- High breakdown voltage ( $BV_{CE0} \geq 50V$ )
- High-current driving ( $I_c(\max) = 400mA$ )
- Active L-level input

## APPLICATIONS

Interfaces between microcomputers and high-voltage, high-current drive systems, drives of relays and printers, and MOS-bipolar logic IC interfaces.

## FUNCTION

The M54566 is produced by adding PNP transistors to M54522 inputs. Seven circuits having active L-level inputs are provided.

Resistance of  $8k\Omega$  is provided between each input and PNP transistor base. The input emitters are connected to Vcc pin (pin 9). Output transistor emitters are all connected to the GND pin (pin 8).

Collector current is 400mA maximum. Collector-emitter supply voltage is 50V maximum.

These ICs are optimal for drivers that are driven with N-MOSIC output and absorb collector current.

## PIN CONFIGURATION

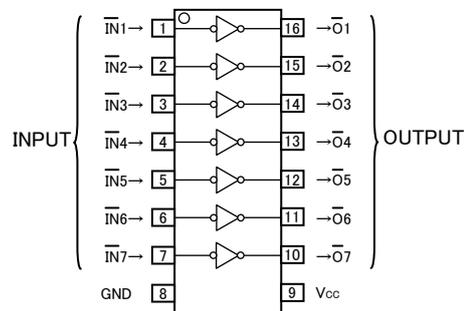

Package type 16P2X-B

## CIRCUIT DIAGRAM

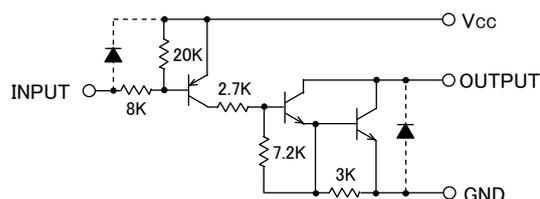

The seven circuits share the Vcc and GND. The diode, indicated with the dotted line, is parasitic, and cannot be used.

Unit:  $\Omega$

## ABSOLUTE MAXIMUM RATINGS (Unless otherwise noted, $T_a = -20 \sim +75^\circ C$ )

Symbol	Parameter	Conditions	Ratings	Unit
Vcc	Supply voltage		10	V
V <sub>CEO</sub>	Collector-emitter voltage	Output, H	- 0.5 ~ + 50	V
I <sub>c</sub>	Collector current	Current per circuit output, L	400	mA
V <sub>i</sub>	Input voltage		- 0.5 ~ Vcc	V
P <sub>d</sub>	Power dissipation	T <sub>a</sub> = 25°C, when mounted on board	1.00	W
T <sub>opr</sub>	Operating temperature		- 20 ~ + 75	°C
T <sub>stg</sub>	Storage temperature		- 55 ~ + 125	°C

**RECOMMENDED OPERATING CONDITIONS**

Symbol	Parameter	Limits			Unit	
		min	typ	max		
V <sub>CC</sub>	Supply voltage	4	5	8	V	
V <sub>O</sub>	Output voltage	0	—	50	V	
I <sub>C</sub>	Collector current (Current per 1 circuit when 7 circuits are coming on simultaneously) V <sub>CC</sub> =5V	Duty Cycle no more than 6%	0	—	350	mA
		Duty Cycle no more than 20%	0	—	200	
V <sub>IH</sub>	“H” input voltage	V <sub>CC</sub> -0.2	—	V <sub>CC</sub>	V	
V <sub>IL</sub>	“L” input voltage	0	—	V <sub>CC</sub> -3	V	

**ELECTRICAL CHARACTERISTICS** (Unless otherwise noted, T<sub>a</sub> = -20~+75°C)

Symbol	Parameter	Test conditions	Limits			Unit
			min	typ*	max	
V <sub>(BR)CEO</sub>	Collector-emitter breakdown voltage	I <sub>CEO</sub> = 100 μA	50	—	—	V
V <sub>CE(sat)</sub>	Collector-emitter saturation voltage	V <sub>I</sub> = V <sub>CC</sub> -3V I <sub>C</sub> = 350mA I <sub>C</sub> = 200mA	—	1.1 0.9	2.2 1.6	V
I <sub>I</sub>	Input current	V <sub>I</sub> = V <sub>CC</sub> -3.5V	—	-0.3	-0.58	mA
I <sub>CC</sub>	Supply current (one circuit coming on)	V <sub>CC</sub> = 5V, V <sub>I</sub> = V <sub>CC</sub> -3.5V	—	1.4	3.0	mA
h <sub>FE</sub>	DC amplification factor	V <sub>CE</sub> = 4V, V <sub>CC</sub> = 5V, I <sub>C</sub> = 350mA, T <sub>a</sub> = 25°C	2000	10000	—	—

\*: The typical values are those measured under ambient temperature (T<sub>a</sub>) of 25°C. There is no guarantee that these values are obtained under any conditions.

**SWITCHING CHARACTERISTICS** (Unless otherwise noted, T<sub>a</sub> = 25°C)

Symbol	Parameter	Test conditions	Limits			Unit
			min	typ	max	
t <sub>on</sub>	Turn-on time	C <sub>L</sub> = 15pF (note 1)	—	95	—	ns
t <sub>off</sub>	Turn-off time		—	2500	—	ns

**NOTE 1 TEST CIRCUIT**

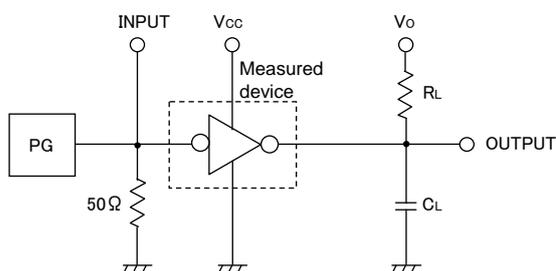

- (1) Pulse generator (PG) characteristics: PRR = 1kHz, t<sub>w</sub> = 10 μs, t<sub>r</sub> = 6ns, t<sub>f</sub> = 6ns, Z<sub>o</sub> = 50 Ω, V<sub>I</sub> = 1 to 4V
- (2) Input-output conditions : R<sub>L</sub> = 30 Ω, V<sub>O</sub> = 10V, V<sub>CC</sub> = 4V
- (3) Electrostatic capacity C<sub>L</sub> includes floating capacitance at connections and input capacitance at probes

**TIMING DIAGRAM**

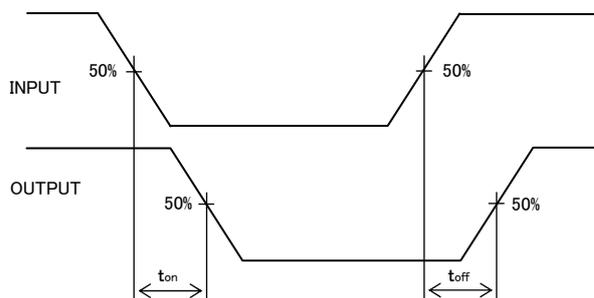

TYPICAL CHARACTERISTICS

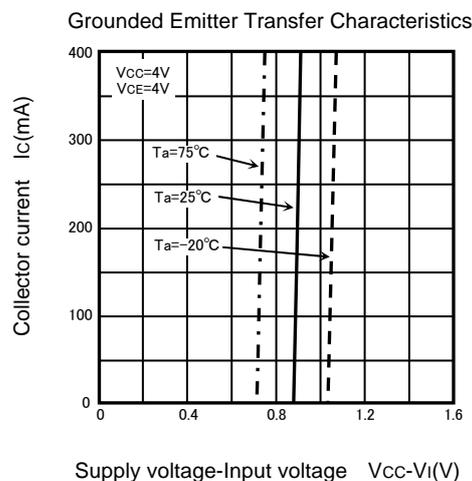
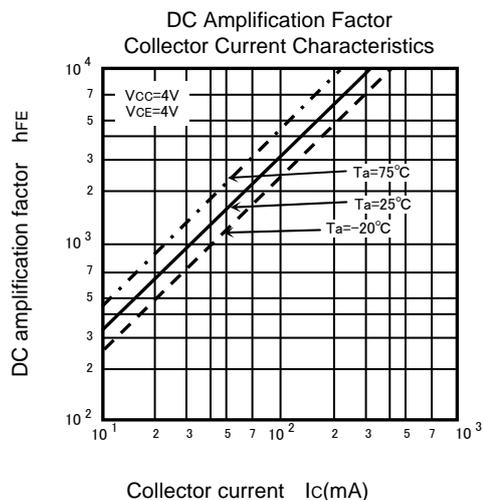
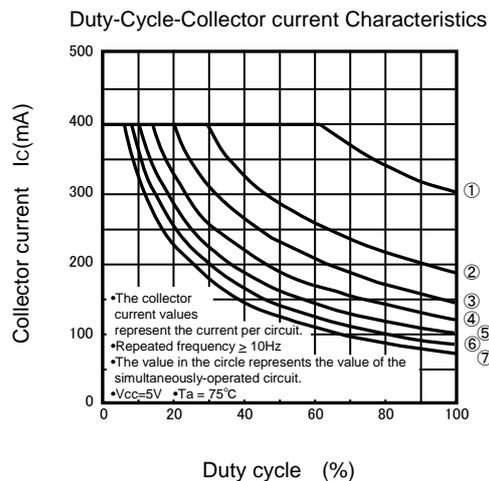
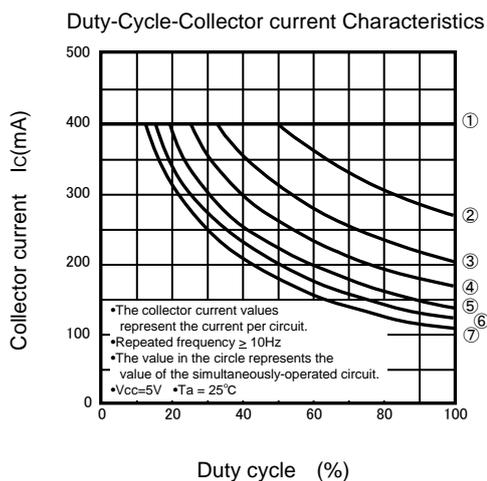
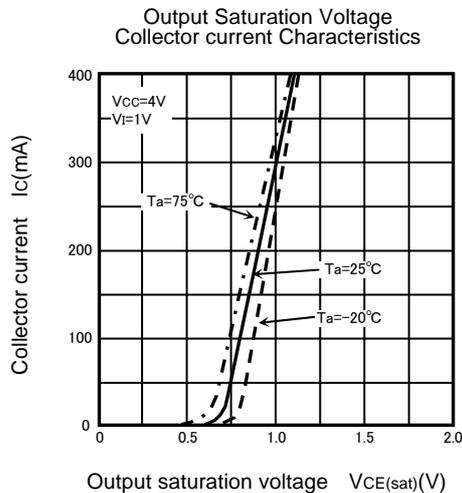
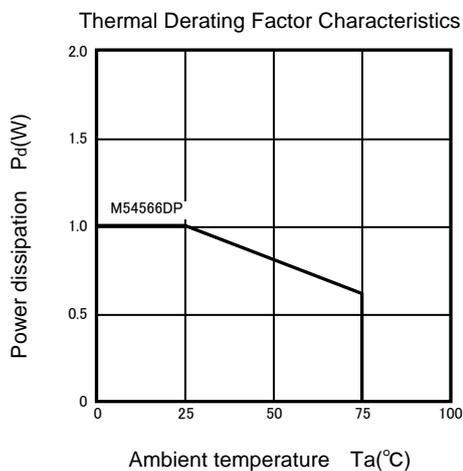

Input Characteristics

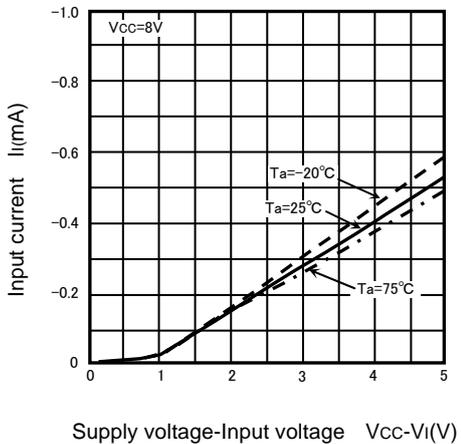

Supply Current Characteristics

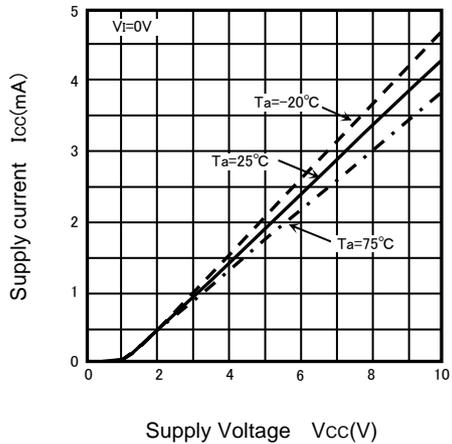

PRELIMINARY

7-UNIT 400mA DARLINGTON TRANSISTOR ARRAY

PACKAGE OUTLINE

16P2X-B

Plastic 16pin 225mil SOP

