

# MAXIM

## Wideband Fast-Settling Operational Amplifier

MX3554/BB3554

### General Description

The BB3554/MX3554 is a very high performance Hybrid operational amplifier with JFET inputs and high-speed high-drive bipolar output. The combination of respectable DC specifications with unusually complete AC, noise, and transient specifications guaranteed over a wide range of conditions results in an amplifier that can be used in a wide variety of applications.

The BB3554/MX3554 slews at  $1000V/\mu s$  and outputs up to  $\pm 100mA$  at  $\pm 10V$ . As a fast-settling amplifier, the BB3554/MX3554 reaches its final value within 150ns to a  $\pm 0.05\%$  error band.

### Applications

- Baseband Video Amplifiers
- Test Equipment
- Waveform Generators
- Pulse Amplifiers
- Fast A/D and D/A Converters

### Features

- ◆ 1000 V/ $\mu s$  Slew Rate
- ◆ Settling-Time 150ns Max
- ◆ Full Differential Input
- ◆ 100mA Minimum Output Current
- ◆ Drives Coaxial Cable Directly

### Ordering Information

PART	TEMP. RANGE	PACKAGE
BB3554AM	-25° C to +85° C	8 Lead TO-3
BB3554BM	-25° C to +85° C	8 Lead TO-3
BB3554SM	-55° C to +125° C	8 Lead TO-3
MX3554AM	-25° C to +85° C	8 Lead TO-3
MX3554BM	-25° C to +85° C	8 Lead TO-3
MX3554SM	-55° C to +125° C	8 Lead TO-3

### Typical Operating Circuit

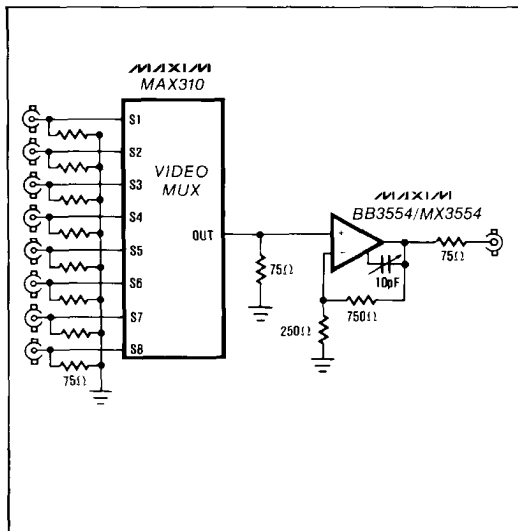

### Pin Configuration

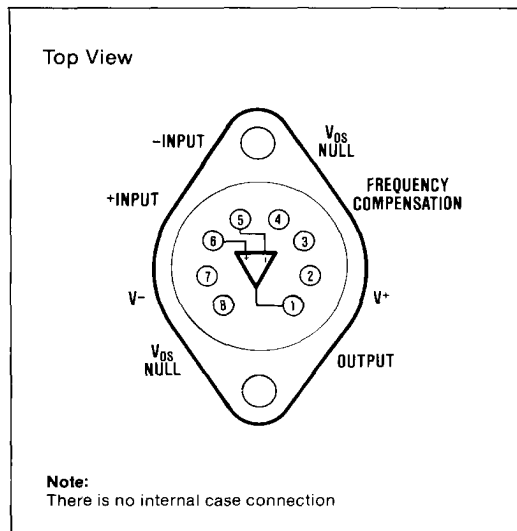

**MAXIM**

Maxim Integrated Products 1

Call toll free 1-800-998-8800 for free samples or literature.

# Wideband Fast-Settling Operational Amplifier

## ABSOLUTE MAXIMUM RATINGS

Supply Voltage ( $V^+$  to  $V^-$ ) ..... 40V  
 Input Voltage .....  $V^+$  to  $V^-$   
 Continuous Output Current .....  $\pm 150$ mA  
 Peak Output Current .....  $\pm 250$ mA  
 Power Dissipation (See Curves) ..... 3.5W  
 (Derate linearly above  $+50^\circ\text{C}$  at  $36^\circ\text{C/W}$  to zero at  $+75^\circ\text{C}$ )

Operating Temperature Range  
 BB3554SM and MX3554SM .....  $-55^\circ\text{C} \leq T_A \leq +125^\circ\text{C}$   
 BB3554AM, BB3554BM,  
 MX3554AM, MX3554BM .....  $-25^\circ\text{C} \leq T_A \leq +85^\circ\text{C}$   
 Junction Temperature .....  $+175^\circ\text{C}$   
 Storage Temperature .....  $-65^\circ\text{C} \leq T_A \leq +150^\circ\text{C}$   
 Lead Temperature (Soldering, 10 Seconds) .....  $+300^\circ\text{C}$

*Stresses above those listed under "Absolute Maximum Ratings" may cause permanent damage to the device. These are stress ratings only, and functional operation of the device at these or any other conditions above those indicated in the operational sections of the specification is not implied. Exposure to absolute maximum ratings conditions for extended periods may affect the device reliability.*

## DC ELECTRICAL CHARACTERISTICS

( $V_S = \pm 15\text{V}$ ;  $T_{\text{CASE}} = +25^\circ\text{C}$  unless otherwise specified.)

PARAMETER	SYMBOL	CONDITIONS	BB3554AM/ MX3554AM			BB3554BM/ MX3554BM			BB3554SM/ MX3554SM			UNITS
			MIN	TYP	MAX	MIN	TYP	MAX	MIN	TYP	MAX	
Open-Loop Voltage Gain	$A_{\text{VOL}}$	$V_{\text{OUT}} = \pm 10\text{V}$	100	106		100	106		100	106		dB
		$R_L = 100\Omega$	90	96		90	96		90	96		
Output Voltage Swing	$V_{\text{OUT}}$	$I_{\text{OUT}} = \pm 100\text{mA}$	$\pm 10$	$\pm 11$		$\pm 10$	$\pm 11$		$\pm 10$	$\pm 11$		V
Output Current Swing	$I_{\text{OUT}}$	$V_O = \pm 10\text{V}$	$\pm 100$	$\pm 125$		$\pm 100$	$\pm 125$		$\pm 100$	$\pm 125$		mA
Output Resistance	$R_{\text{OUT}}$	$f = 10\text{MHz}$	20			20			20			$\Omega$
Input Offset Voltage	$V_{\text{OS}}$	$T_A = +25^\circ\text{C}$	0.5	2.0		0.2	1.0		0.2	1.0		mV
Average Temperature Coefficient of Offset Voltage		$T_{\text{MIN}} < T_C < T_{\text{MAX}}$	20	50		8	15		12	25		$\mu\text{V}/^\circ\text{C}$
Power Supply Rejection Ratio	PSRR	$\pm 10\text{V}$ to $\pm 18\text{V}$ $T_{\text{MIN}} < T_C < T_{\text{MAX}}$	80	300		80	300		80	300		$\mu\text{V/V}$
Input Bias Current	$I_B$	(Note 1) $T_{\text{MIN}} < T_C < T_{\text{MAX}}$	0	-10	-50	0	-10	-50	0	-10	-50	pA
			-0.64			-0.64			-10			nA
IB vs Supply			1			1			1			$\text{pA/V}$
Input Offset Current	$I_{\text{OS}}$		2	10		2	10		2	10		pA
Input Resistance	$R_{\text{DIFF}}$		$10^{11}$			$10^{11}$			$10^{11}$			$\Omega$
	$R_{\text{CM}}$		$10^{11}$			$10^{11}$			$10^{11}$			
Input Capacitance	$C_{\text{IN}}$		2.0			2.0			2.0			pF
Common-Mode Input Range	$V_{\text{CM}}$	Linear Operation	$\pm(V_{\text{CC}} - 6)$			$\pm(V_{\text{CC}} - 6)$			$\pm(V_{\text{CC}} - 6)$			V
Maximum Safe Input Voltage	$V_{\text{CM}(\text{MAX})}$		V-	V+		V-	V+		V-	V+		V
Common-Mode Rejection Ratio	CMR	$f = \text{DC}$ , $V_{\text{CM}} = +5\text{V}$ to $-10\text{V}$	60	78		60	78		60	78		dB
Rated Supply Voltage			$\pm 15\text{V}$			$\pm 15\text{V}$			$\pm 15\text{V}$			V
Voltage Range, Derated Performance			$\pm 10\text{V}$	$\pm 18\text{V}$		$\pm 10\text{V}$	$\pm 18\text{V}$		$\pm 10\text{V}$	$\pm 18\text{V}$		V
Supply Current, Quiescent			17	28	45	17	28	45	17	28	45	mA

**Note 1:** Specification is at  $+25^\circ\text{C}$  case temperature due to requirements of high speed automatic testing. Actual values at operating temperature will exceed the value at  $T_J = +25^\circ\text{C}$ . When supply voltages are  $\pm 15\text{V}$ , no-load operating junction temperature without a heat sink may rise  $20\text{-}30^\circ\text{C}$  above ambient, and more under heavy load conditions. Accordingly,  $I_B$  will change significantly during warm-up. Refer to  $I_B$  vs temperature graph for expected values.

# Wideband Fast-Settling Operational Amplifier

MX3554/BB3554

## AC ELECTRICAL CHARACTERISTICS

(T<sub>case</sub> = +25°C, V<sub>S</sub> = ±15V, R<sub>S</sub> = 50Ω, R<sub>L</sub> = 50Ω)

PARAMETER	SYMBOL	CONDITIONS	BB3554AM MX3554AM			BB3554BM MX3554BM			BB3554SM MX3554SM			UNITS
			MIN.	TYP.	MAX.	MIN.	TYP.	MAX.	MIN.	TYP.	MAX.	
Bandwidth (Note 2)	BW	0dB Small Signal, C <sub>F</sub> = 0	70	90		70	90		70	90		MHz
Gain-Bandwidth Product (Note 3)	GBW	C <sub>F</sub> = 0, Gain = 10 V/V C <sub>F</sub> = 0, Gain = 100 V/V C <sub>F</sub> = 0, Gain = 1000 V/V	150 425 1000	225 725 1700		150 425 1000	225 725 1700		150 425 1000	225 725 1700		MHz
Full Power Bandwidth (Note 3)	BW	R <sub>L</sub> = 100Ω, V <sub>IN</sub> = ±10V, C <sub>F</sub> = 0	16	19		16	19		16	19		MHz
Slew Rate (Note 3)	SR	R <sub>L</sub> = 100Ω, V <sub>IN</sub> = ±10V, C <sub>F</sub> = 0	1000	1200		1000	1200		1000	1200		V/μs
Settling Time (Note 3)		to 1%, Gain = -1 to 0.1%, Gain = -1 to 0.05%, Gain = -1 to 0.01%, Gain = -1		60 120 140 200	150 250		60 120 140 200	150 250		60 120 140 200	150 250	ns
Input Noise Voltage (Note 2)	e <sub>N</sub>	R <sub>S</sub> = 100Ω, f <sub>0</sub> = 1Hz		125	450		125	450		125	450	nV√Hz
		R <sub>S</sub> = 100Ω, f <sub>0</sub> = 10Hz		50	160		50	160		50	160	
		R <sub>S</sub> = 100Ω, f <sub>0</sub> = 100Hz		25	90		25	90		25	90	
		R <sub>S</sub> = 100Ω, f <sub>0</sub> = 1KHz		15	50		15	50		15	50	
		R <sub>S</sub> = 100Ω, f <sub>0</sub> = 10KHz		10	35		10	35		10	35	
		R <sub>S</sub> = 100Ω, f <sub>0</sub> = 100KHz		8	25		8	25		8	25	
		R <sub>S</sub> = 100Ω, f <sub>0</sub> = 1MHz		7	25		7	25		7	25	
		R <sub>S</sub> = 100Ω, f <sub>0</sub> = 0.3Hz to 10Hz		2	7		2	7		2	7	μV <sub>P-P</sub>
		R <sub>S</sub> = 100Ω, f <sub>0</sub> = 10Hz to 1MHz		8	25		8	25		8	25	μV <sub>RMS</sub>
Input Noise Current (Note 2)	i <sub>N</sub>	f <sub>0</sub> = 0.3Hz to 10Hz f <sub>0</sub> = 10Hz to 1MHz		45 2			45 2			45 2		fA, p-p pA, RMS

**Note 2:** These parameters are untested and not guaranteed. This specification is established to a 90% confidence level.

**Note 3:** These parameters are sample tested to 10% LTPD.

## Test Circuits

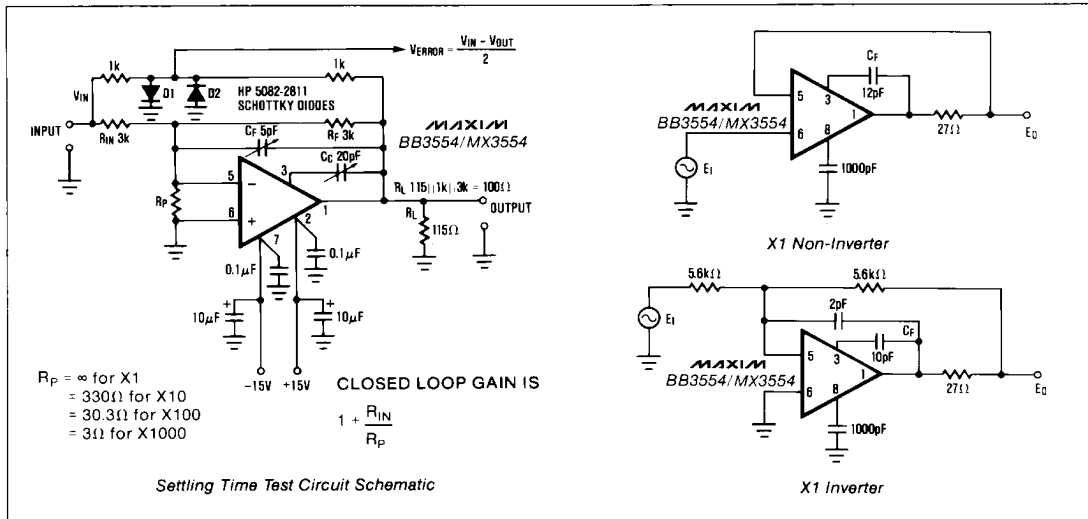

MAXIM

## Wideband Fast-Settling Operational Amplifier

### Test Circuits (continued)

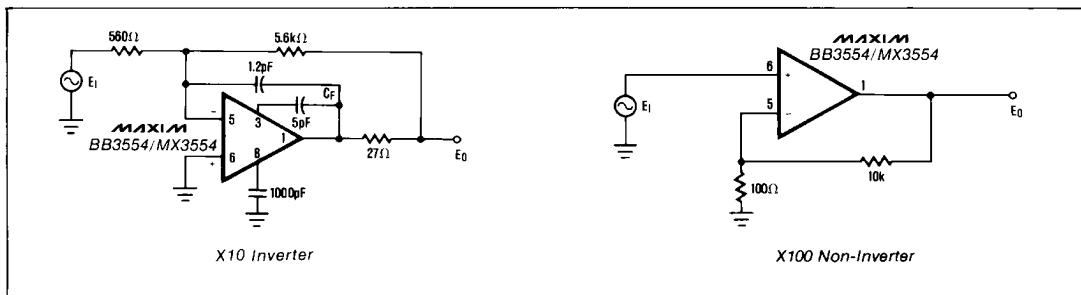

### Application Hints

#### Layout Considerations

Layout is one of the most important areas of high frequency circuit design. An excellent circuit design may yield only marginal performance if insufficient attention is paid to circuit layout. Operating very high bandwidth devices, such as the BB3554/MX3554, at low closed-loop gains will generally exacerbate the problem.

A ground plane is highly recommended for all applications using high-speed amplifiers. The low resistance, low inductance, and high frequency shielding attainable with a ground plane are advantageous in almost any application.

IC sockets should generally be avoided, as they cause parasitic inductances and capacitances to appear at all pins. If it is required that the device be removable, use individual Hypertronics YSK0102-004 sockets for each of the device pins used.

#### Power Supply Decoupling

The positive and negative power supply terminals of the BB3554/MX3554 must be well bypassed to ground. Maxim suggests solid tantalum capacitors of about 4.7μf backed-up with high-frequency capacitors such as monolithic ceramics with good performance at 100MHz. The high frequency decoupling capacitors should be placed as close as possible to the device pins. These capacitors must be returned to the same ground point on the ground plane or connected by a short, wide circuit board trace of low inductance and resistance.

#### Frequency Compensation

The BB3554/MX3554 is internally compensated for closed-loop gains above 50 so the user can optimise bandwidth, slew-rate, and/or settling-time at lower gains by selection of external compensation capacitors. Compensation capacitance is connected between

pins 1 and 3, a value of 10pF provides unity-gain stability. For gains up to 50 the value is decreased to zero. The exact value depends on a number of factors including closed-loop gain, layout, and load capacitance.

Settling-time performance into a capacitive load of 1000pF or more may be improved by isolating the load capacitance from the amplifier with a low value resistor of the order of 27Ω. The compensation capacitor remains connected directly from pins 1 to 3, but the output and feedback connections are made to the other end of the new resistor. A 1000pF capacitor from pin 8 to ground can also be beneficial.

High-speed operational amplifiers ordinarily need some capacitance across the feedback resistor to compensate for the inevitable shunt capacitance at the inverting input. The value required is small (typically 2pF) and is repeatable from device to device, so it may be practical to incorporate the feedback capacitor into the PC layout as planned stray capacitance.

#### Offset Voltage Adjustment

The BB3554/MX3554 is laser trimmed for minimum offset voltage. The residual offset error may be trimmed by a 10kΩ or 20kΩ linear potentiometer connected between pins 4 and 8 with the wiper connected to V<sup>+</sup>. Note that pins 4 and 8 are very sensitive to capacitively coupled pickup. The effect can be minimized by connecting series resistors between the null pins and the null potentiometer, the resistors must be placed close to the BB3554/MX3554. The value of these resistors should be as high as possible consistent with adequate adjustment range, at least 1kΩ is recommended. It is generally undesirable to absorb system offsets by adjusting the amplifier's offset away from zero as this may cause the amplifier's temperature coefficient to be degraded. It is preferable to adjust the system offset in some other manner such as offsetting the non-inverting input of the amplifier or summing a correction signal at the inverting input.

# Wideband Fast-Settling Operational Amplifier

## Typical Operating Characteristics

MX3554/BB3554

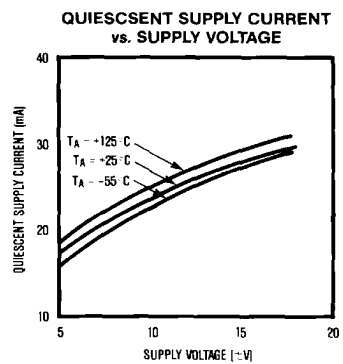
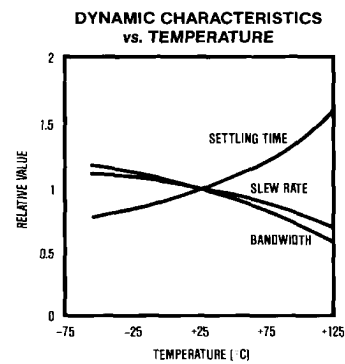
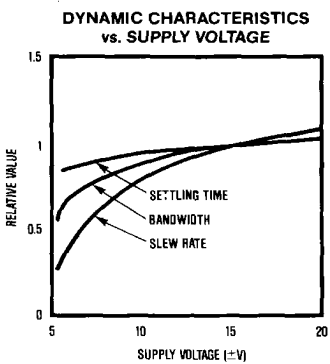
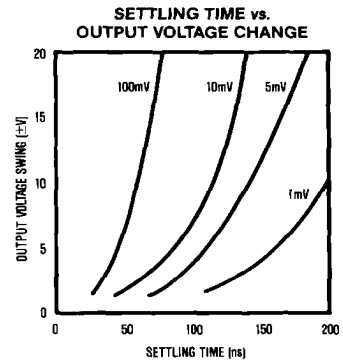
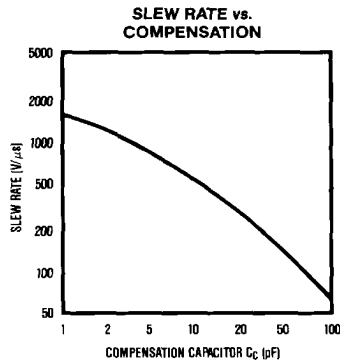
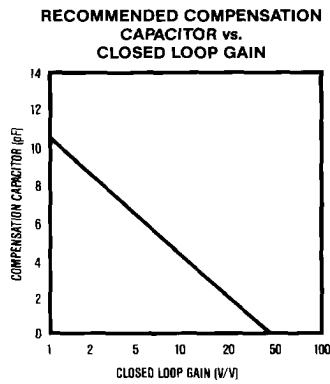
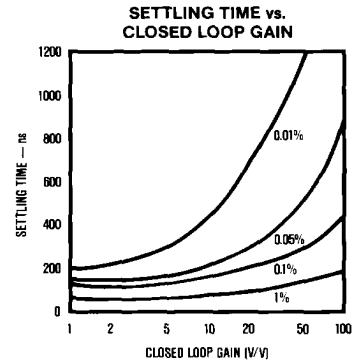
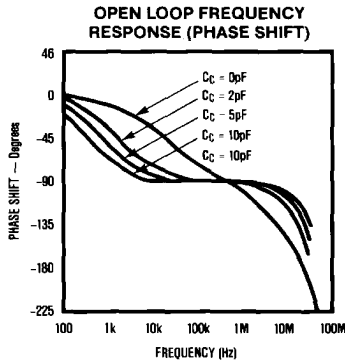
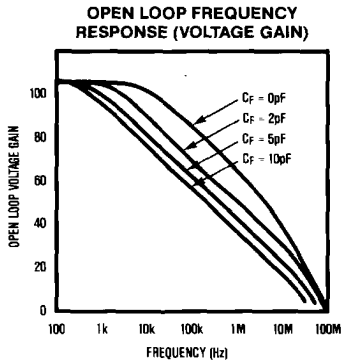

## Wideband Fast-Settling Operational Amplifier

### Typical Operating Characteristics (continued)

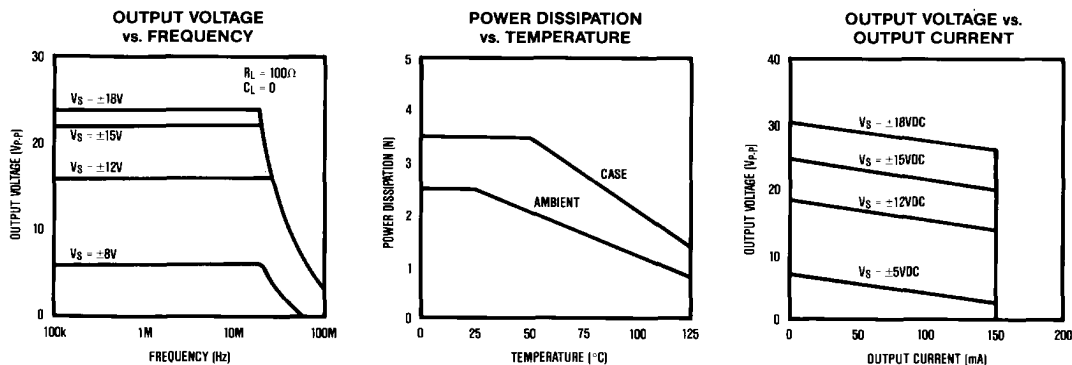

#### Common-Mode Voltage Range

Note that while it is safe to apply common-mode voltage up to and including both the positive and negative power supplies, the common-mode rejection ratio is specified from -10V to +7V. When the BB3554/MX3554 is operated up to the common-mode limit of -11V to +11V the common-mode rejection ratio will be reduced. The common-mode voltage range must be considered when operating with asymmetrical power supplies or when running large voltage swings at low non-inverting gains.

#### Short-Circuit Protection

The BB3554/MX3554 is short-circuit protected for continuous output shorts to ground, but not to the power supplies. Output shorts to either supply will destroy the device, even for momentary connections. Output shorts to other potential sources are not recommended as they may cause permanent damage.

#### Guarding

Low bias current and high impedance applications may require the addition of guard rings to divert leakage currents away from the BB3554/MX3554's input terminals. The guard should completely surround the amplifier inputs and should be held at the same potential as the input signal. In addition to blocking board leakage currents the guard will also reduce signal pickup at the inputs.

In high-frequency applications the increase in input capacitance caused by guarding may be undesirable. However, a small capacitor placed across the feedback resistor will compensate for the increased input capacitance.

#### Heat Sinking

The BB3554/MX3554 does not require heat sinking for most light load applications. For heavy loads and/or high temperature conditions a heat sink will be necessary. Table 1 lists some representative heat-sinks for the 8 lead TO3 package.

Table 1. Heat Sinks for BB3554/MX3554

Manufacturer	Part #
Thermalloy	6002-19
IERC	LAIC3B4CB HPI-TO3-33CB
AAVID	5423B,5426B,5327B 5791,5197B-15

Ordinarily, the heat sink will be in electrical contact with the case. The case of the BB3554/MX3554 is not internally connected, so the user is free to connect the case/heat sink to ground, to the output or to simply leave it floating as dictated by the application.

IERC  
135 W. Magnolia Bl.  
Burbank, CA 91502  
(818) 786-1182  
Thermalloy  
P.O. Box 34829  
Dallas, TX 75234  
(214) 243-4321

AAVID Engineering  
One Kool Path  
Box 400  
Laconia, NH 03247  
(603) 524-4443  
Hypertronics  
16 Brent Dr.  
Hudson, MA 01749  
(617) 568-0541