



## QUAD MICROPPOWER RAIL-TO-RAIL CMOS OPERATIONAL AMPLIFIER

### GENERAL DESCRIPTION

The ALD4701 is a quad monolithic CMOS micropower high slew rate operational amplifier intended for a broad range of analog applications using  $\pm 1V$  to  $\pm 6V$  dual power supply systems, as well as  $+2V$  to  $+12V$  battery operated systems. All device characteristics are specified for  $+5V$  single supply or  $\pm 2.5V$  dual supply systems. Total supply current for all four operational amplifiers is 1mA maximum at 5V supply voltage. It is manufactured with Advanced Linear Devices' enhanced ACMOS silicon gate CMOS process.

The ALD4701 is designed to offer a trade-off of performance parameters providing a wide range of desired specifications. It offers the popular industry standard pin configuration of LM324 types and ICL 7641 types.

The ALD4701 has been developed specifically for the  $+5V$  single supply or  $\pm 1V$  to  $\pm 6V$  dual supply user. Several important characteristics of the device make application easier to implement at these voltages.

First, each operational amplifier can operate with rail to rail input and output voltages. This means the signal input voltage and output voltage can be equal to or near to the positive and negative supply voltages. This feature allows numerous analog serial stages and flexibility in input signal bias levels. Secondly, each device was designed to accommodate mixed applications where digital and analog circuits may operate off the same power supply or battery. Thirdly, the output stage can typically drive up to 50pF capacitive and 10K $\Omega$  resistive loads.

These features, combined with extremely low input currents, high open loop voltage gain of 100V/mV, useful bandwidth of 700KHz, a slew rate of 0.7V/ $\mu$ s, low power dissipation of 5mW, low offset voltage and temperature drift, make the ALD4701 a versatile, micropower quad operational amplifier.

The ALD4701, designed and fabricated with silicon gate CMOS technology, offers 1pA typical input bias current. Due to low voltage and low power operation, reliability and operating characteristics, such as input bias currents and warm up time, are greatly improved.

### ORDERING INFORMATION

Operating Temperature Range*		
-55°C to +125°C	0°C to +70°C	0°C to +70°C
14-Pin CERDIP Package	14-Pin Small Outline Package (SOIC)	14-Pin Plastic Dip Package
ALD4701A DB	ALD4701A SB	ALD4701A PB
ALD4701B DB	ALD4701B SB	ALD4701B PB
ALD4701 DB	ALD4701 SB	ALD4701 PB

\* Contact factory for industrial temperature range

### FEATURES

- All parameters specified for  $+5V$  single supply or  $\pm 2.5V$  dual supply systems
- Rail-to-rail input and output voltage ranges
- Unity gain stable
- Extremely low input bias currents -- 1.0pA
- High source impedance applications
- Dual power supply  $\pm 1.0V$  to  $\pm 6.0V$
- Single power supply  $+2V$  to  $+12V$
- High voltage gain
- Output short circuit protected
- Unity gain bandwidth of 0.7MHz
- Slew rate of 0.7V/ $\mu$ s
- Low power dissipation
- Symmetrical output drive

### APPLICATIONS

- Voltage follower/buffer/amplifier
- Charge integrator
- Photodiode amplifier
- Data acquisition systems
- High performance portable instruments
- Signal conditioning circuits
- Sensor and transducer amplifiers
- Low leakage amplifiers
- Active filters
- Sample/Hold amplifier
- Picoammeter
- Current to voltage converter

### PIN CONFIGURATION

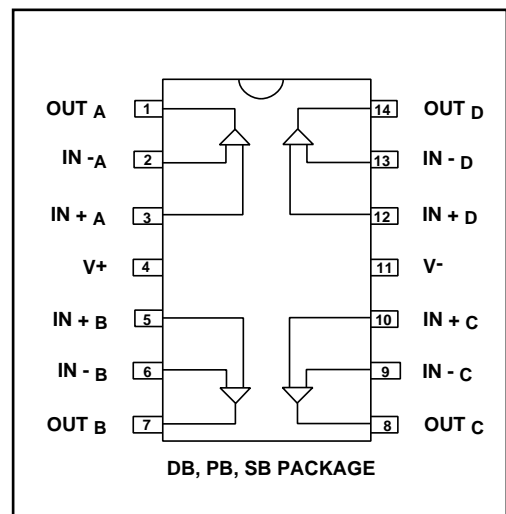

## ABSOLUTE MAXIMUM RATINGS

Supply voltage,  $V^+$  \_\_\_\_\_ 13.2V  
 Differential input voltage range \_\_\_\_\_ -0.3V to  $V^+ + 0.3V$   
 Power dissipation \_\_\_\_\_ 600 mW  
 Operating temperature range PB,SB package \_\_\_\_\_  $0^{\circ}C$  to  $+70^{\circ}C$   
 DB package \_\_\_\_\_  $-55^{\circ}C$  to  $+125^{\circ}C$   
 Storage temperature range \_\_\_\_\_  $-65^{\circ}C$  to  $+150^{\circ}C$   
 Lead temperature, 10 seconds \_\_\_\_\_  $+260^{\circ}C$

## OPERATING ELECTRICAL CHARACTERISTICS

$T_A = 25^{\circ}C$   $V^+ = 5.0V$  ( $V_S = \pm 2.5V$  in dual supply operation) unless otherwise specified

Parameter	Symbol	4701A			4701B			4701			Unit	Test Conditions
		Min	Typ	Max	Min	Typ	Max	Min	Typ	Max		
Supply Voltage	$V_S$ $V^+$	$\pm 1.0$ 2.0		$\pm 6.0$ 12.0	$\pm 1.0$ 2.0		$\pm 6.0$ 12.0	$\pm 1.0$ 2.0		$\pm 6.0$ 12.0	V V	Dual Supply Single Supply
Input Offset Voltage	$V_{OS}$			2.0 2.8			5.0 5.8			10.0 11.0	mV mV	$R_S \leq 100K\Omega$ $0^{\circ}C \leq T_A \leq +70^{\circ}C$
Input Offset Current	$I_{OS}$		1.0	25 240		1.0	25 240		1.0	25 240	pA pA	$T_A = 25^{\circ}C$ $0^{\circ}C \leq T_A \leq +70^{\circ}C$
Input Bias Current	$I_B$		1.0	30 300		1.0	30 300		1.0	30 300	pA pA	$T_A = 25^{\circ}C$ $0^{\circ}C \leq T_A \leq +70^{\circ}C$
Input Voltage Range	$V_{IR}$	-0.3 -2.8		5.3 2.8	-0.3 -2.8		5.3 2.8	-0.3 -2.8		5.3 2.8	V V	$V^+ = +5V$ $V_S = \pm 2.5V$
Input Resistance	$R_{IN}$		$10^{12}$			$10^{12}$			$10^{12}$		$\Omega$	
Input Offset Voltage Drift	$TCV_{OS}$		5			5			7		$\mu V/^{\circ}C$	$R_S \leq 100K\Omega$
Power Supply Rejection Ratio	PSRR	65 65	80 80		65 65	80 80		60 60	80 80		dB dB	$R_S \leq 100K\Omega$ $0^{\circ}C \leq T_A \leq +70^{\circ}C$
Common Mode Rejection Ratio	CMRR	65 65	83 83		65 65	83 83		60 60	83 83		dB dB	$R_S \leq 100K\Omega$ $0^{\circ}C \leq T_A \leq +70^{\circ}C$
Large Signal Voltage Gain	$A_V$	15 10	100 300		15 10	100 300		10 7	80 300		V/mV V/mV V/mV	$R_L = 100K\Omega$ $R_L \geq 1M\Omega$ $R_L = 100K\Omega$ $0^{\circ}C \leq T_A \leq +70^{\circ}C$
Output Voltage Range	$V_{O\ low}$ $V_{O\ high}$	4.99	0.001 4.999	0.01	4.99	0.001 4.999	0.01	4.99	0.001 4.999	0.01	V V	$R_L = 1M\Omega$ $V^+ = 5V$ $0^{\circ}C \leq T_A \leq +70^{\circ}C$
	$V_{O\ low}$ $V_{O\ high}$	2.40	-2.48 2.48	-2.40	2.40	-2.48 2.48	-2.40	2.40	-2.48 2.48	-2.40	V V	$R_L = 100K\Omega$ $V_S = \pm 2.5V$ $0^{\circ}C \leq T_A \leq +70^{\circ}C$
Output Short Circuit Current	$I_{SC}$		1			1			1		mA	
Supply Current	$I_S$		480	1000		480	1000		480	1000	$\mu A$	$V_{IN} = 0V$ No Load
Power Dissipation	$P_D$			5.0			5.0			5.0	mW	All amplifiers $V_S = \pm 2.5V$

**OPERATING ELECTRICAL CHARACTERISTICS (cont'd)**
 **$T_A = 25^\circ\text{C}$   $V_S = \pm 2.5\text{V}$  unless otherwise specified**

Parameter	Symbol	4701A			4701B			4701			Unit	Test Conditions
		Min	Typ	Max	Min	Typ	Max	Min	Typ	Max		
Input Capacitance	$C_{IN}$		1			1			1		pF	
Bandwidth	BW		700			700			700		KHz	
Slew Rate	$S_R$		0.7			0.7			0.7		V/ $\mu\text{s}$	$A_V = +1$ $R_L = 100\text{K}\Omega$
Rise time	$t_r$		0.2			0.2			0.2		$\mu\text{s}$	$R_L = 100\text{K}\Omega$
Overshoot Factor			20			20			20		%	$R_L = 100\text{K}\Omega$ $C_L = 50\text{pF}$
Settling Time	$t_s$		10.0			10.0			10.0		$\mu\text{s}$	0.1% $A_V = -1$ $C_L = 50\text{pF}$ $R_L = 100\text{K}\Omega$
Channel Separation	$C_S$		120			120			120		dB	$A_V = 100$

 **$T_A = 25^\circ\text{C}$   $V_S = \pm 5.0\text{V}$  unless otherwise specified**

Parameter	Symbol	4701A			4701B			4701			Unit	Test Conditions
		Min	Typ	Max	Min	Typ	Max	Min	Typ	Max		
Power Supply Rejection Ratio	PSRR		83			83			83		dB	$R_S \leq 100\text{K}\Omega$
Common Mode Rejection Ratio	CMRR		83			83			83		dB	$R_S \leq 100\text{K}\Omega$
Large Signal Voltage Gain	$A_V$		250			250			250		V/mV	$R_L = 100\text{K}\Omega$
Output Voltage Range	$V_{O\text{ low}}$ $V_{O\text{ high}}$	4.90	-4.98 4.98	-4.90	4.90	-4.98 -4.90	-4.90	4.90	-4.98 4.98	-4.90	V V	$R_L = 100\text{K}\Omega$
Bandwidth	BW		1.0			1.0			1.0		MHz	
Slew Rate	$S_R$		1.0			1.0			1.0		V/ $\mu\text{s}$	$A_V = +1$ $C_L = 50\text{pF}$

 **$V_S = \pm 2.5\text{V}$   $-55^\circ\text{C} \leq T_A \leq +125^\circ\text{C}$  unless otherwise specified**

Parameter	Symbol	4701A DB			4701B DB			4701 DB			Unit	Test Conditions
		Min	Typ	Max	Min	Typ	Max	Min	Typ	Max		
Input Offset Voltage	$V_{OS}$			3.0			6.0			15.0	mV	$R_S \leq 100\text{K}\Omega$
Input Offset Current	$I_{OS}$			8.0			8.0			8.0	nA	
Input Bias Current	$I_B$			10.0			10.0			10.0	nA	
Power Supply Rejection Ratio	PSRR	60	75		60	75		60	75		dB	$R_S \leq 100\text{K}\Omega$
Common Mode Rejection Ratio	CMRR	60	83		60	83		60	83		dB	$R_S \leq 100\text{K}\Omega$
Large Signal Voltage Gain	$A_V$	10	50		10	50		7	50		V/mV	$R_L = 100\text{K}\Omega$
Output Voltage Range	$V_{O\text{ low}}$ $V_{O\text{ high}}$	2.35	-2.47 2.45	-2.40	2.35	-2.47 2.45	-2.40	2.35	-2.47 2.45	-2.40	V V	$R_L = 100\text{K}\Omega$

## Design & Operating Notes:

1. The ALD4701 CMOS operational amplifier uses a 3 gain stage architecture and an improved frequency compensation scheme to achieve large voltage gain, high output driving capability, and better frequency stability. In a conventional CMOS operational amplifier design, compensation is achieved with a pole splitting capacitor together with a nulling resistor. This method is, however, very bias dependent and thus cannot accommodate the large range of supply voltage operation as is required from a stand alone CMOS operational amplifier. The ALD4701 is internally compensated for unity gain stability using a novel scheme that does not use a nulling resistor. This scheme produces a clean single pole roll off in the gain characteristics while providing for more than 70 degrees of phase margin at the unity gain frequency.
2. The ALD4701 has complementary p-channel and n-channel input differential stages connected in parallel to accomplish rail-to-rail input common mode voltage range. This means that with the ranges of common mode input voltage close to the power supplies, one of the two differential stages is switched off internally. To maintain compatibility with other operational amplifiers, this switching point has been selected to be about 1.5V below the positive supply voltage. Since offset voltage trimming on the ALD4701 is made when the input voltage is symmetrical to the supply voltages, this internal switching does not affect a large variety of applications such as an inverting amplifier or non-inverting amplifier with a gain larger than 2.5 (5V operation), where the common mode voltage does not make excursions above this switching point. The user should however, be aware that this switching does take place if the operational amplifier is connected as a unity gain buffer and should make provision in his design to allow for input offset voltage variations.
3. The input bias and offset currents are essentially input protection diode reverse bias leakage currents, and are typically less than 1pA

at room temperature. This low input bias current assures that the analog signal from the source will not be distorted by input bias currents. Normally, this extremely high input impedance of greater than  $10^{12}\Omega$  would not be a problem as the source impedance would limit the node impedance. However, for applications where source impedance is very high, it may be necessary to limit noise and hum pickup through proper shielding.

4. The output stage consists of class AB complementary output drivers, capable of driving a low resistance load. The output voltage swing is limited by the drain to source on-resistance of the output transistors as determined by the bias circuitry, and the value of the load resistor. When connected in the voltage follower configuration, the oscillation resistant feature, combined with the rail to rail input and output feature, makes an effective analog signal buffer for medium to high source impedance sensors, transducers, and other circuit networks.
5. The ALD4701 operational amplifier has been designed to provide full static discharge protection. Internally, the design has been carefully implemented to minimize latch up. However, care must be exercised when handling the device to avoid strong static fields that may degrade a diode junction, causing increased input leakage currents. In using the operational amplifier, the user is advised to power up the circuit before, or simultaneously with, any input voltages applied and to limit input voltages not to exceed 0.3V of the power supply voltage levels.
6. The ALD4701, with its micropower operation, offers numerous benefits in reduced power supply requirements, less noise coupling and current spikes, less thermally induced drift, better overall reliability due to lower self heating, and lower input bias current. It requires practically no warm up time as the chip junction heats up to only 0.4°C above ambient temperature under most operating conditions.

## TYPICAL PERFORMANCE CHARACTERISTICS

**SUPPLY CURRENT AS A FUNCTION OF SUPPLY VOLTAGE**

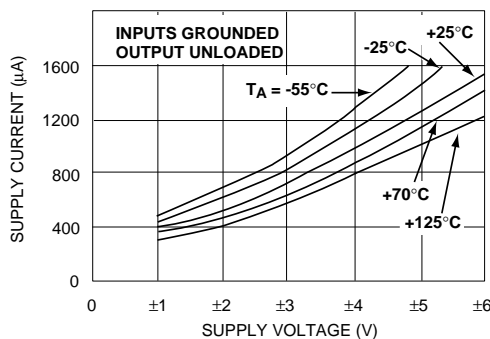

**OPEN LOOP VOLTAGE GAIN AS A FUNCTION OF LOAD RESISTANCE**

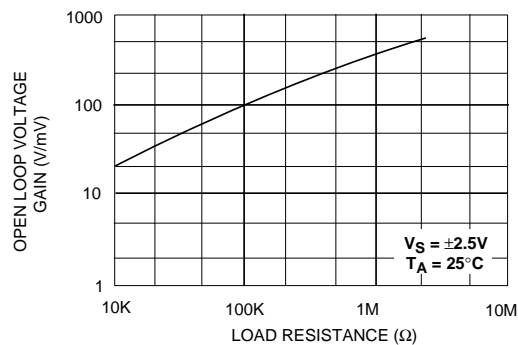

**COMMON MODE INPUT VOLTAGE RANGE AS A FUNCTION OF SUPPLY VOLTAGE**

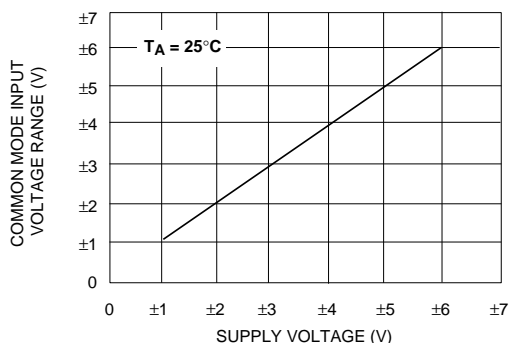

**INPUT BIAS CURRENT AS A FUNCTION OF AMBIENT TEMPERATURE**

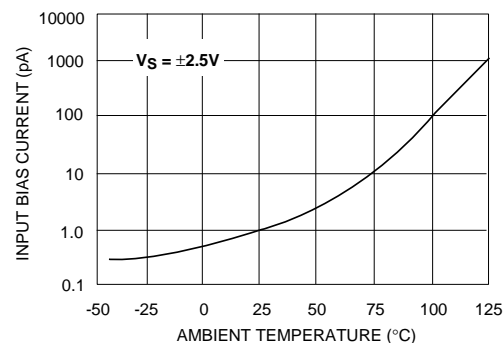

# TYPICAL PERFORMANCE CHARACTERISTICS

**OPEN LOOP VOLTAGE GAIN AS A FUNCTION OF SUPPLY VOLTAGE AND TEMPERATURE**

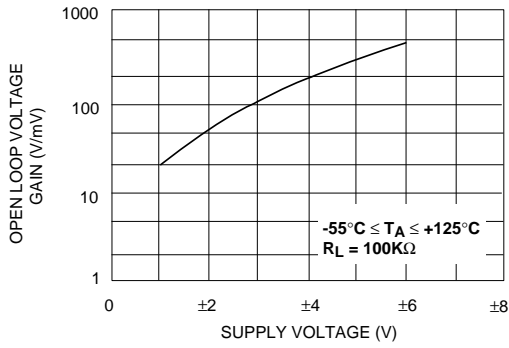

**OUTPUT VOLTAGE SWING AS A FUNCTION OF SUPPLY VOLTAGE**

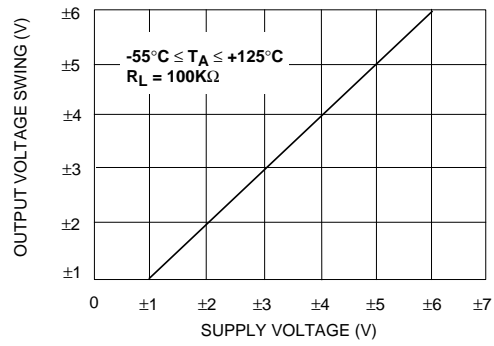

**INPUT OFFSET VOLTAGE AS A FUNCTION OF AMBIENT TEMPERATURE REPRESENTATIVE UNITS**

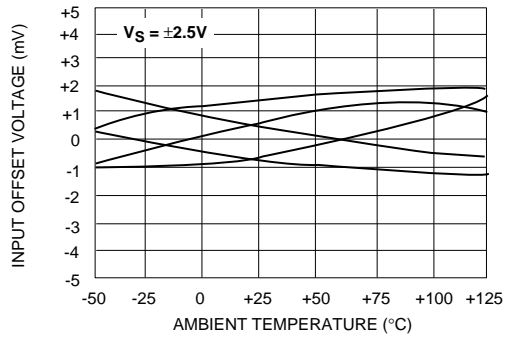

**OPEN LOOP VOLTAGE GAIN AS A FUNCTION OF FREQUENCY**

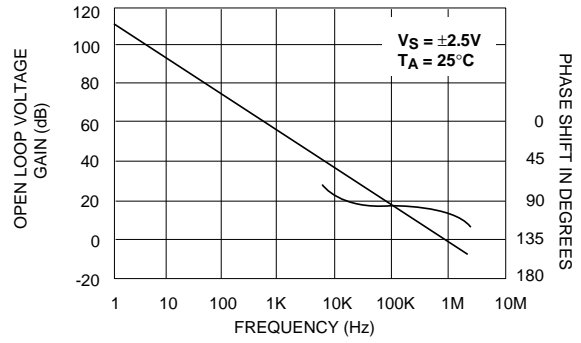

**INPUT OFFSET VOLTAGE AS A FUNCTION OF COMMON MODE INPUT VOLTAGE**

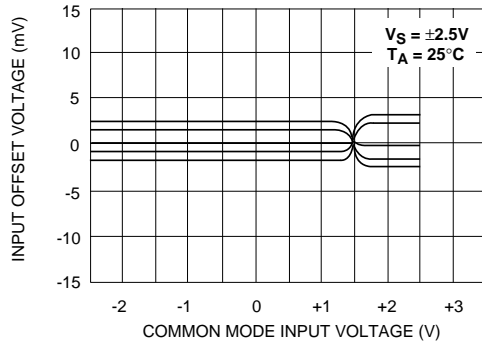

**LARGE - SIGNAL TRANSIENT RESPONSE**

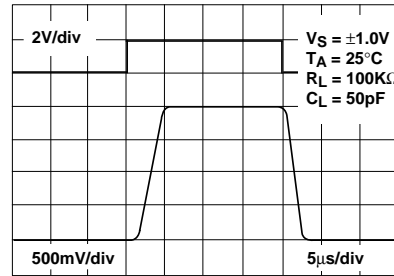

**LARGE - SIGNAL TRANSIENT RESPONSE**

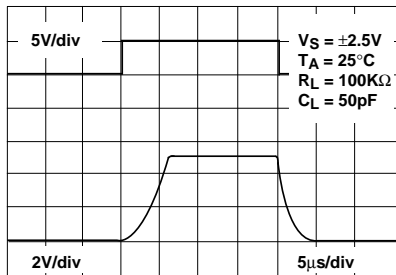

**SMALL - SIGNAL TRANSIENT RESPONSE**

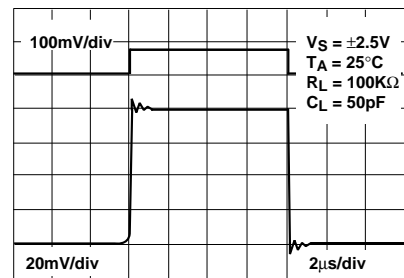

# TYPICAL APPLICATIONS

## RAIL-TO-RAIL VOLTAGE FOLLOWER/BUFFER

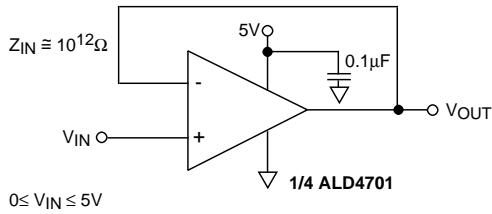

## TRANSCONDUCTANCE AMPLIFIER

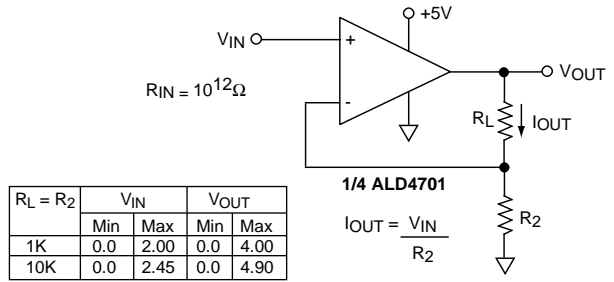

## HIGH INPUT IMPEDANCE RAIL-TO-RAIL PRECISION DC SUMMING AMPLIFIER

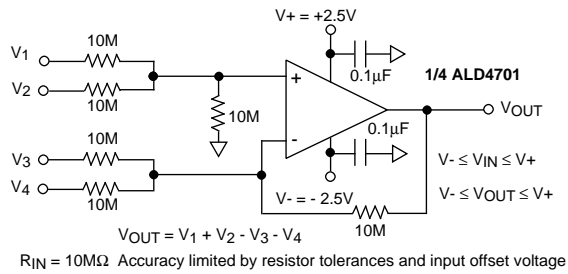

## PHOTO DETECTOR CURRENT TO VOLTAGE CONVERTER

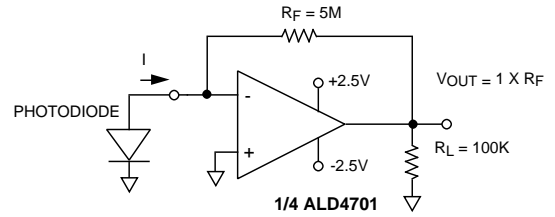

## WIEN BRIDGE OSCILLATOR (RAIL-TO-RAIL) SINE WAVE GENERATOR

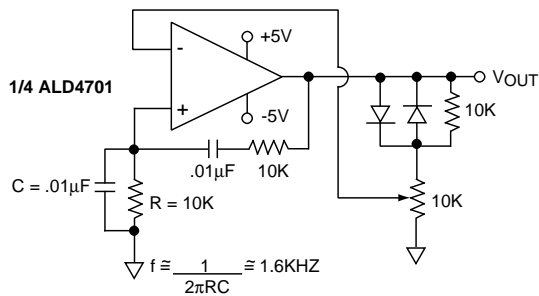

## RAIL-TO-RAIL WINDOW COMPARATOR

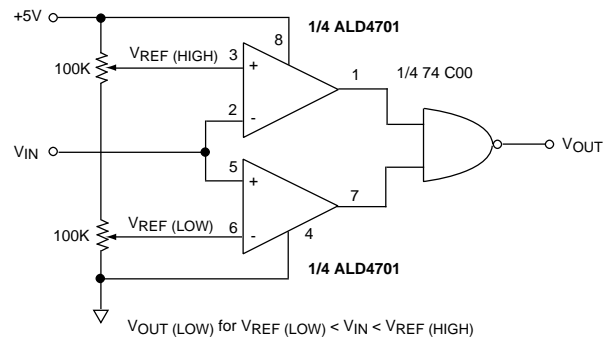

## FUNCTION GENERATOR

