

Spezifikation für Freigabe / specification for release

Kunde / customer :
 Artikelnummer / part number :

768775282



Bezeichnung : **WE-PD2 High Voltage**
 description : **WE-PD2 High Voltage**

DATUM / DATE : 2011-11-17

A Mechanische Abmessungen / dimensions:

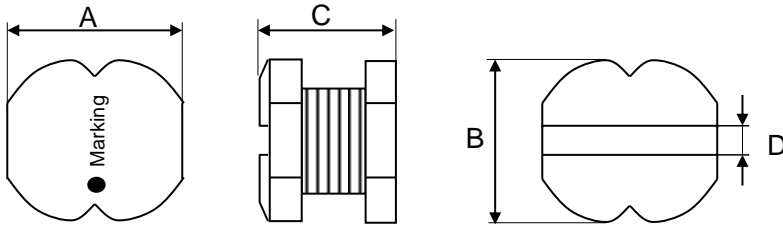

	Typ L	
A	7,0 ± 0,3	mm
B	7,8 ± 0,3	mm
C	5,0 ± 0,5	mm
D	3,0 ref	mm
E	7,5 ref	mm
F	8,0 ref	mm
G	2,0 ref	mm
H	3,0 ref	mm

● = Start of winding Marking = Inductance code

B Elektrische Eigenschaften / electrical properties:

Eigenschaften / properties	Testbedingungen / test conditions		Wert / value	Einheit / unit	tol.
Induktivität / inductance	100 kHz / 0,25V	L	820	μH	± 10%
DC-Widerstand / DC-resistance	@ 20°C	R _{DC typ}	2,35	Ω	typ.
DC-Widerstand / DC-resistance	@ 20°C	R _{DC max}	2,77	Ω	max.
Nennstrom / rated current	ΔT=40 K	I _{DC}	0,35	A	max.
Sättigungsstrom / saturation current	 ΔL/L <10%	I _{sat}	0,35	A	typ.

C Lötpad / soldering spec.:

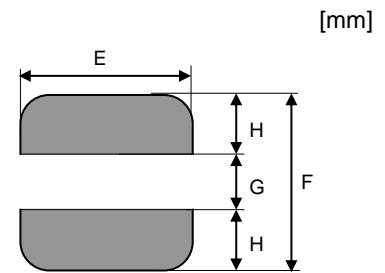

D Prüfgeräte / test equipment:

Wayne Kerr 3260B für/for L₀
Dostmann T905 Thermometer für/for I_{DC}
Baker DWX-05-PD für/for Surge/Impuls test
400V_{DC} surge proof according WE-STD1516

E Testbedingungen / test conditions:

Luftfeuchtigkeit / humidity: 33%
 Umgebungstemperatur / temperature: +20°C

F Werkstoffe & Zulassungen / material & approvals:

Basismaterial / base material: Ferrit
 Thermanal finish: Ag /Ni barrier / matte Sn
 Draht / wire: Class H

G Eigenschaften / general specifications:

Betriebstemp. / operating temperature: -40°C - + 125°C
 Umgebungstemp. / ambient temperature: -40°C - + 85°C
 It is recommended that the temperature of the part does not exceed 125°C under worst case operating conditions

Freigabe erteilt / general release:	Kunde / customer		
Datum / date	Unterschrift / signature		
Geprüft / checked	Würth Elektronik		
Kontrolliert / approved	Name	Änderung / modification	Datum / date
	ALA	Version 3	11-11-17
	ALA	Version 2	11-05-23
	MST	Version 1	09-11-03

Würth Elektronik eiSos GmbH & Co.KG

D-74638 Waldenburg · Max-Eyth-Strasse 1 - 3 · Germany · Telefon (+49) (0) 7942 - 945 - 0 · Telefax (+49) (0) 7942 - 945 - 400
<http://www.we-online.com>

Spezifikation für Freigabe / specification for release

Kunde / customer :
 Artikelnummer / part number : **768775282**
 Bezeichnung : **WE-PD2 High Voltage**
 description : **WE-PD2 High Voltage**



DATUM / DATE : 2011-11-17

H Induktivitätskurve / Inductance curve :

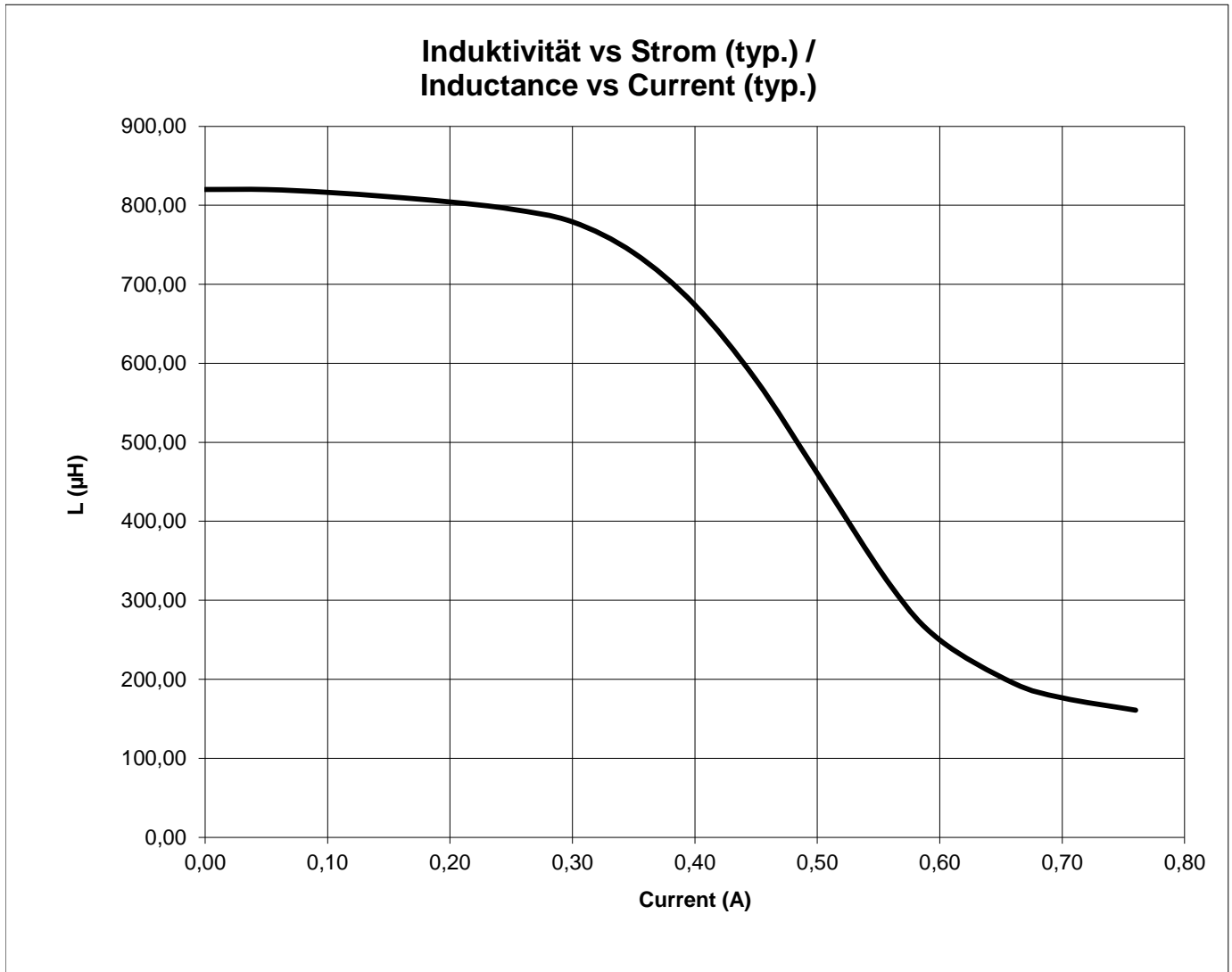

Freigabe erteilt / general release:	Kunde / customer			
Datum / date	Unterschrift / signature			
	Würth Elektronik	ALA	Version 3	11-11-17
		ALA	Version 2	11-05-23
Geprüft / checked	Kontrolliert / approved	MST	Version 1	09-11-03
		Name	Änderung / modification	Datum / date

Würth Elektronik eiSos GmbH & Co.KG

D-74638 Waldenburg · Max-Eyth-Strasse 1 - 3 · Germany · Telefon (+49) (0) 7942 - 945 - 0 · Telefax (+49) (0) 7942 - 945 - 400
<http://www.we-online.com>

Spezifikation für Freigabe / specification for release

Kunde / customer :
 Artikelnummer / part number :

768775282



Bezeichnung : **WE-PD2 High Voltage**
 description : **WE-PD2 High Voltage**

DATUM / DATE : 2011-11-17

I Rollenspezifikation / tape and reel specification:

Gurtspezifikation / Tape specification:

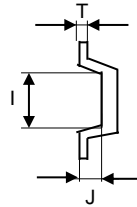
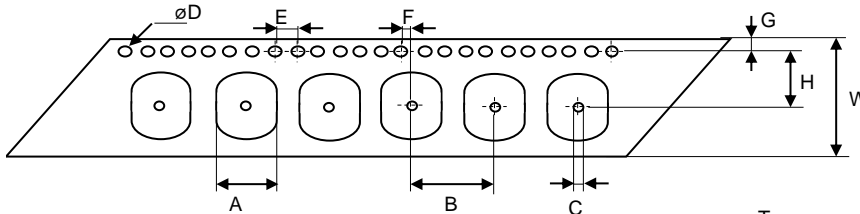

A	7,5 ± 0,1	mm
B	12,0 ± 1,0	mm
C	1,50 +0,1 -0,0	mm
D	1,50 +0,3 -0,1	mm
E	4,00 ± 0,1	mm
F	2,00 ± 0,1	mm
G	1,75 ± 0,1	mm
H	7,50 ± 0,1	mm
I	8,00 ± 0,1	mm
J	5,00 ± 0,1	mm
T	0,35 ± 0,05	mm
W	16,0 ± 0,3	mm

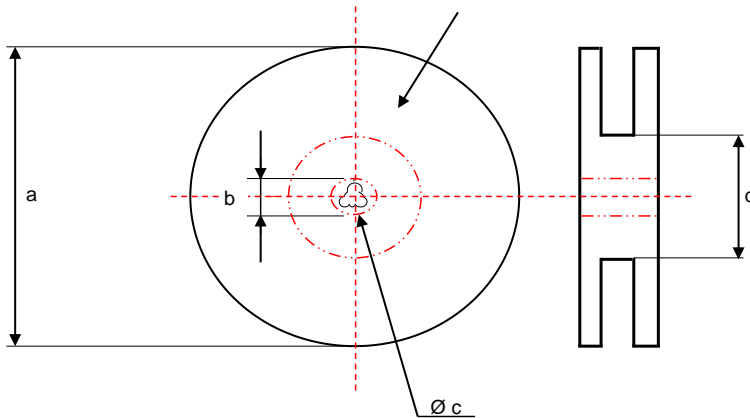

Rollenspezifikation / Reel specification:

a	330,0 ± 0,5	mm
b	20,20 ± 0,1	mm
c	13,00 +0,5 -1,0	mm
d	100,0 ± 1,0	mm

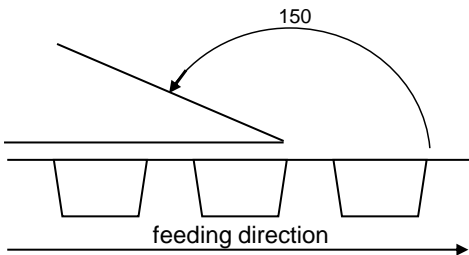

The force for tearing off cover tape is 20 to 70 grams in arrow direction

Freigabe erteilt / general release:	Kunde / customer			
	Datum / date	Unterschrift / signature		
Geprüft / checked	Würth Elektronik	ALA	Version 3	11-11-17
		ALA	Version 2	11-05-23
		MST	Version 1	09-11-03
		Name	Änderung / modification	Datum / date
	Kontrolliert / approved			

This electronic component has been designed and developed for usage in general electronic equipment. Before incorporating this component into any equipment where higher safety and reliability is especially required or if there is the possibility of direct damage or injury to human body, for example in the range of aerospace, aviation, nuclear control, submarine, transportation, (automotive control, train control, ship control), transportation signal, disaster prevention, medical, public information network etc, Würth Elektronik eiSos GmbH must be informed before the design-in stage. In addition, sufficient reliability evaluation checks for safety must be performed on every electronic component which is used in electrical circuits that require high safety and reliability functions or performance.

Würth Elektronik eiSos GmbH & Co.KG

D-74638 Waldenburg · Max-Eyth-Strasse 1 - 3 · Germany · Telefon (+49) (0) 7942 - 945 - 0 · Telefax (+49) (0) 7942 - 945 - 400
<http://www.we-online.com>