

Typical Applications

This HMC753LP4E is ideal for:

- Point-to-Point Radios
- Point-to-Multi-Point Radios
- Military & Space
- Test Instrumentation

Features

Noise Figure: 1.5 dB @ 4 GHz
 Gain: 17 dB
 P1dB Output Power: +18 dBm
 Supply Voltage: +5V @ 55 mA
 Output IP3: +30 dBm
 50 Ohm matched Input/Output
 24 Lead Plastic 4x4mm SMT Package: 16mm²

Functional Diagram

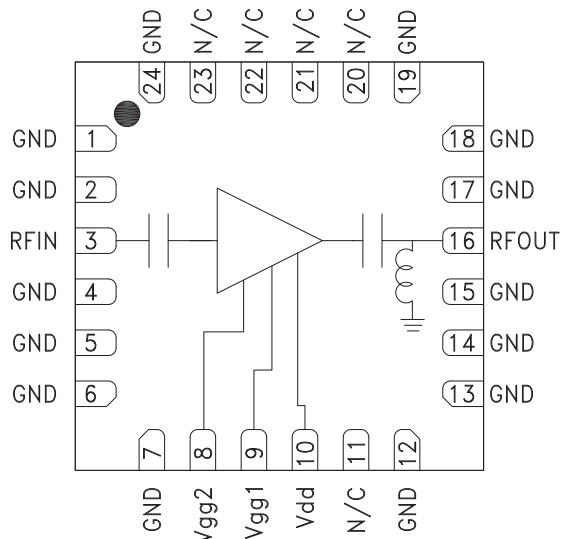

General Description

The HMC753LP4E is a GaAs MMIC Low Noise Wideband Amplifier housed in a leadless 4x4 mm plastic surface mount package. The amplifier operates between 1 and 11 GHz, providing up to 16.5 dB of small signal gain, 1.5 dB noise figure, and output IP3 of +30 dBm, while requiring only 55 mA from a +5V supply. The P1dB output power of up to +18 dBm enables the LNA to function as a LO driver for balanced, I/Q or image reject mixers. The HMC-753LP4E also features I/Os that are DC blocked and internally matched to 50 Ohms, making it ideal for high capacity microwave radios or VSAT applications. This versatile LNA is also available in die form as the HMC-ALH444.

Electrical Specifications, $T_A = +25^\circ\text{C}$, $V_{dd} = +5\text{V}$, $I_{dd} = 55\text{mA}$ ^[2]

Parameter	Min.	Typ.	Max.	Min.	Typ.	Max.	Units	
Frequency Range	1 - 6		6 - 11					GHz
Gain	14	16.5		10	14		dB	
Gain Variation over Temperature		0.004			0.008		dB / °C	
Noise Figure		1.5	2		2	2.7	dB	
Input Return Loss		11			8		dB	
Output Return Loss		18			12		dB	
Output Power for 1 dB Compression		18			15		dBm	
Saturated Output Power (P _{sat})		20			17		dBm	
Output Third Order Intercept (IP3)		30			28		dBm	
Supply Current (I _{dd}) (V _{dd} = 5V, set V _{gg2} = 1.5V, V _{gg1} = -0.8V Typ.)		55			55		mA	



GaAs HEMT MMIC LOW NOISE AMPLIFIER, 1 - 11 GHz

Broadband Gain & Return Loss [1]

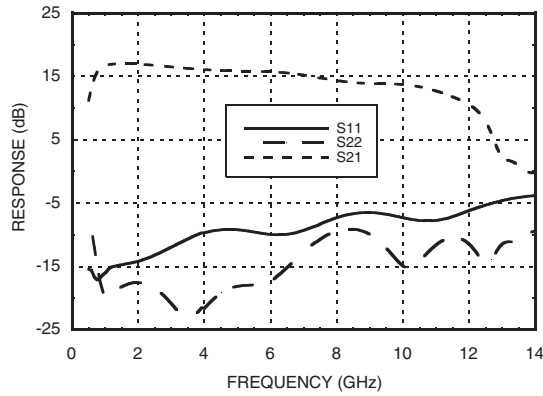

Gain vs. Temperature [1]

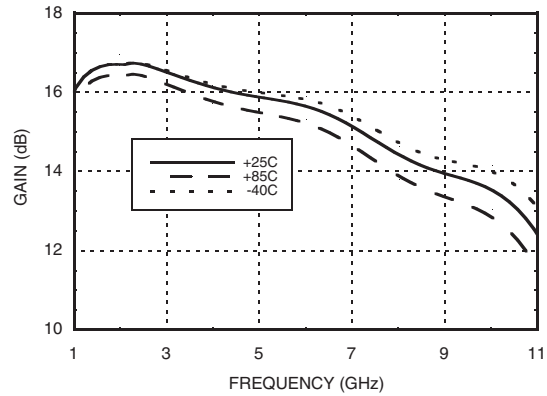

Input Return Loss vs. Temperature

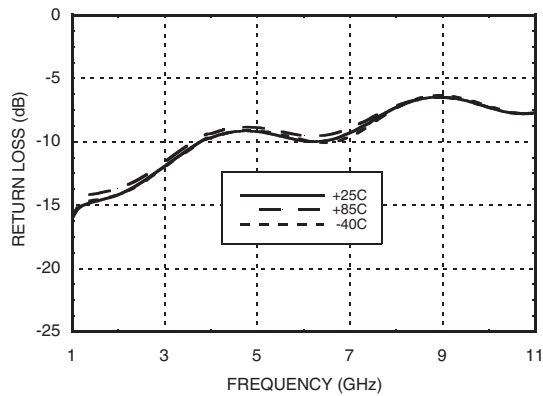

Output Return Loss vs. Temperature

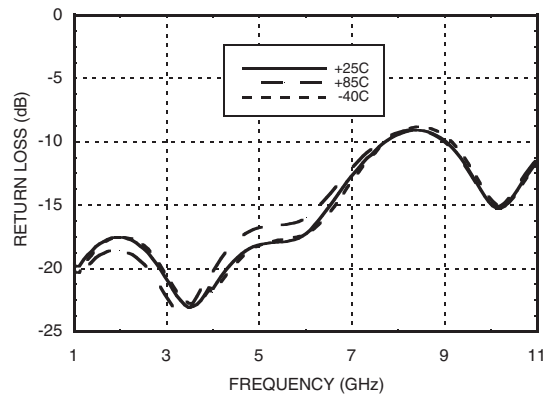

Noise Figure vs. Temperature [1]

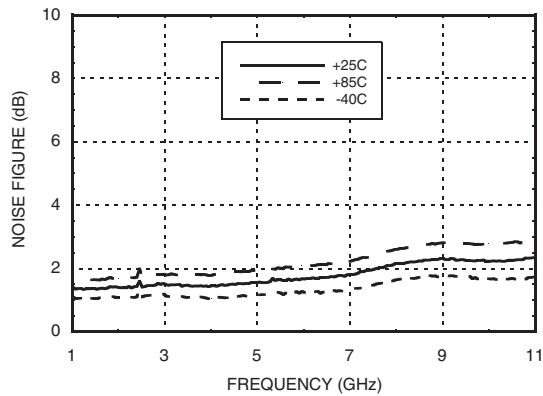

Output IP3 vs. Temperature

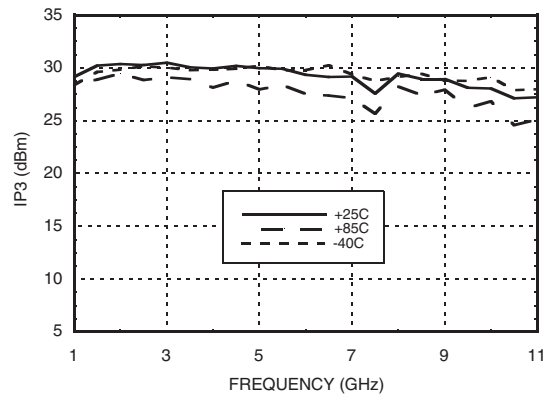

[1] Board loss subtracted out for gain, power and noise figure measurement

P1dB vs. Temperature [1]

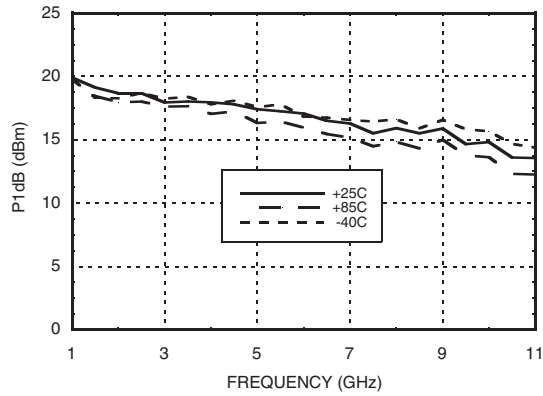

Psat vs. Temperature [1]

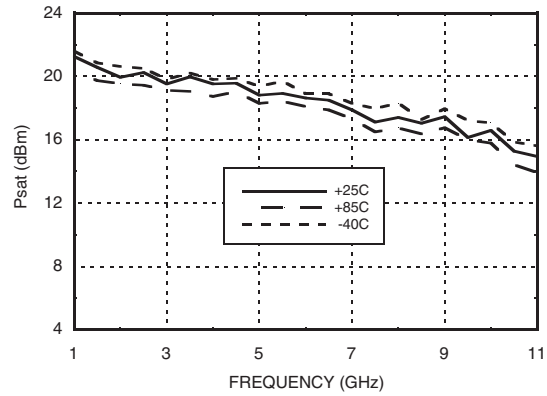

Reverse Isolation vs. Temperature

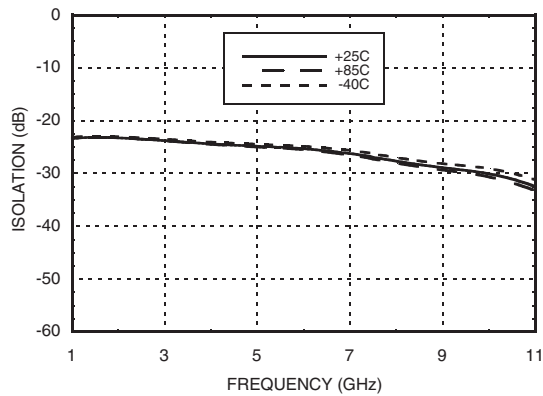

Power Compression @ 6 GHz [1]

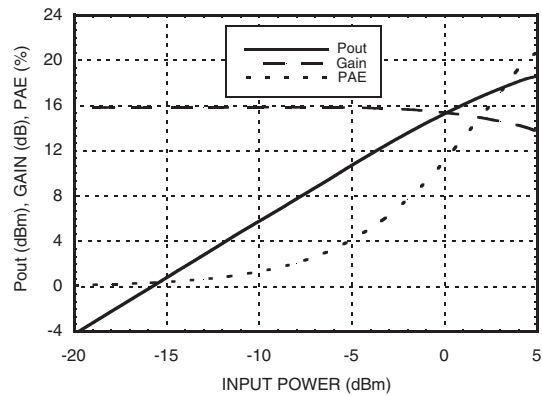

Gain, Noise Figure & Power vs. Supply Voltage @ 6 GHz [1]

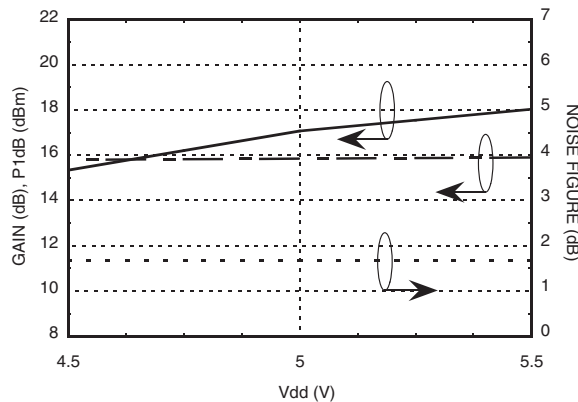

[1] Board loss subtracted out for gain, power and noise figure measurement

Absolute Maximum Ratings

Drain Bias Voltage	+6.0V
RF Input Power	12 dBm
Gate Bias Voltage, V _{gg1}	-1 to 0.3V
Gate Bias Voltage, V _{gg2}	0 to 2.5V
Channel Temperature	180 °C
Continuous P _{diss} (T = 85 °C) (derate 8.4 mW/°C above 85 °C)	0.8 W
Thermal Resistance (Channel to die bottom)	119 °C/W
Storage Temperature	-65 to +150 °C
Operating Temperature	-40 to +85 °C



ELECTROSTATIC SENSITIVE DEVICE
OBSERVE HANDLING PRECAUTIONS

Outline Drawing

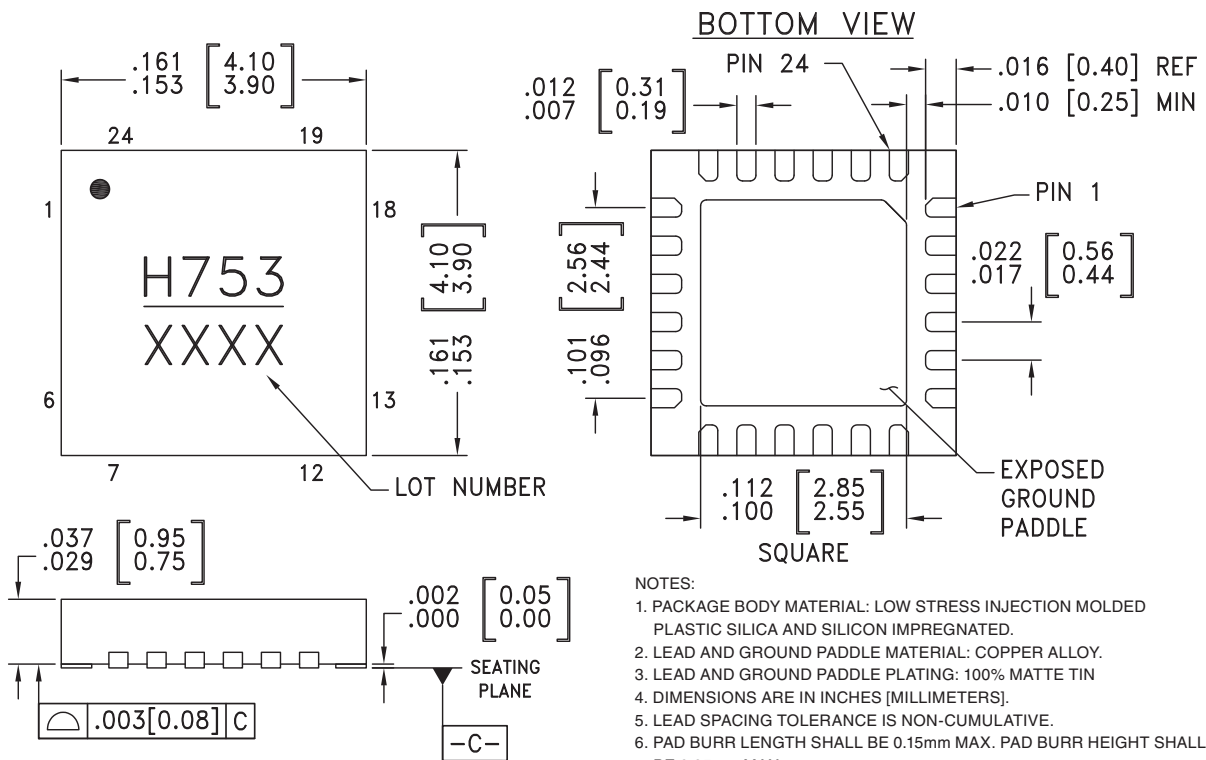

- NOTES:
1. PACKAGE BODY MATERIAL: LOW STRESS INJECTION MOLDED PLASTIC SILICA AND SILICON IMPREGNATED.
 2. LEAD AND GROUND PADDLE MATERIAL: COPPER ALLOY.
 3. LEAD AND GROUND PADDLE PLATING: 100% MATTE TIN
 4. DIMENSIONS ARE IN INCHES [MILLIMETERS].
 5. LEAD SPACING TOLERANCE IS NON-CUMULATIVE.
 6. PAD BURR LENGTH SHALL BE 0.15mm MAX. PAD BURR HEIGHT SHALL BE 0.05mm MAX.
 7. PACKAGE WARP SHALL NOT EXCEED 0.05mm
 8. ALL GROUND LEADS AND GROUND PADDLE MUST BE SOLDERED TO PCB RF GROUND.
 9. REFER TO HITTITE APPLICATION NOTE FOR SUGGESTED PCB LAND PATTERN.

Package Information

Part Number	Package Body Material	Lead Finish	Package Marking ^[1]
HMC753LP4E	RoHS-compliant Low Stress Injection Molded Plastic	100% matte Sn ^[2]	753 XXXX

[1] 4-Digit lot number XXXX

[2] Max peak reflow temperature of 260 °C

Pin Descriptions

Pin Number	Function	Description	Interface Schematic
1, 2, 4 - 7, 12 - 15, 17 - 19, 24	GND	Package bottom has exposed metal paddle that must be connected to RF/DC ground.	
3	RFIN	This pad is AC coupled and matched to 50 Ohms.	
8, 9	Vgg2, 1	Gate control for amplifier. Please follow "MMIC Amplifier Biasing Procedure" application note. See assembly for required external components.	
10	Vdd	Power Supply Voltage for the amplifier. See assembly for required external components.	
11, 20 - 23	N/C	The pins are not connected internally; however, all data shown herein was measured with these pins connected to RF/DC ground externally.	
16	RFOUT	This pad is AC coupled and matched to 50 Ohms.	

Application Circuit

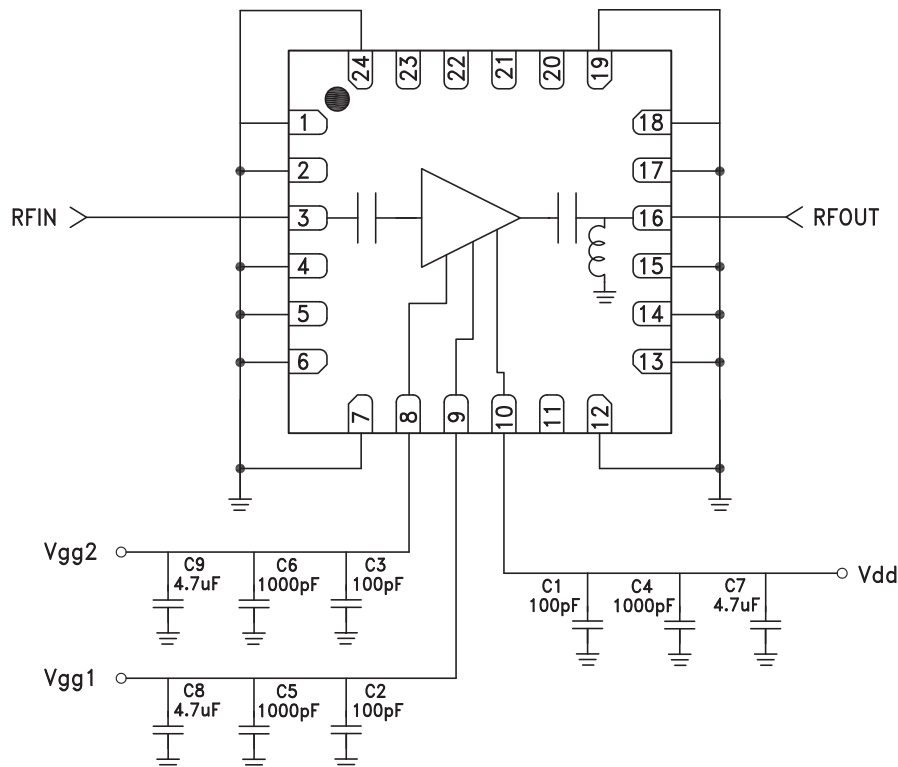

Evaluation PCB

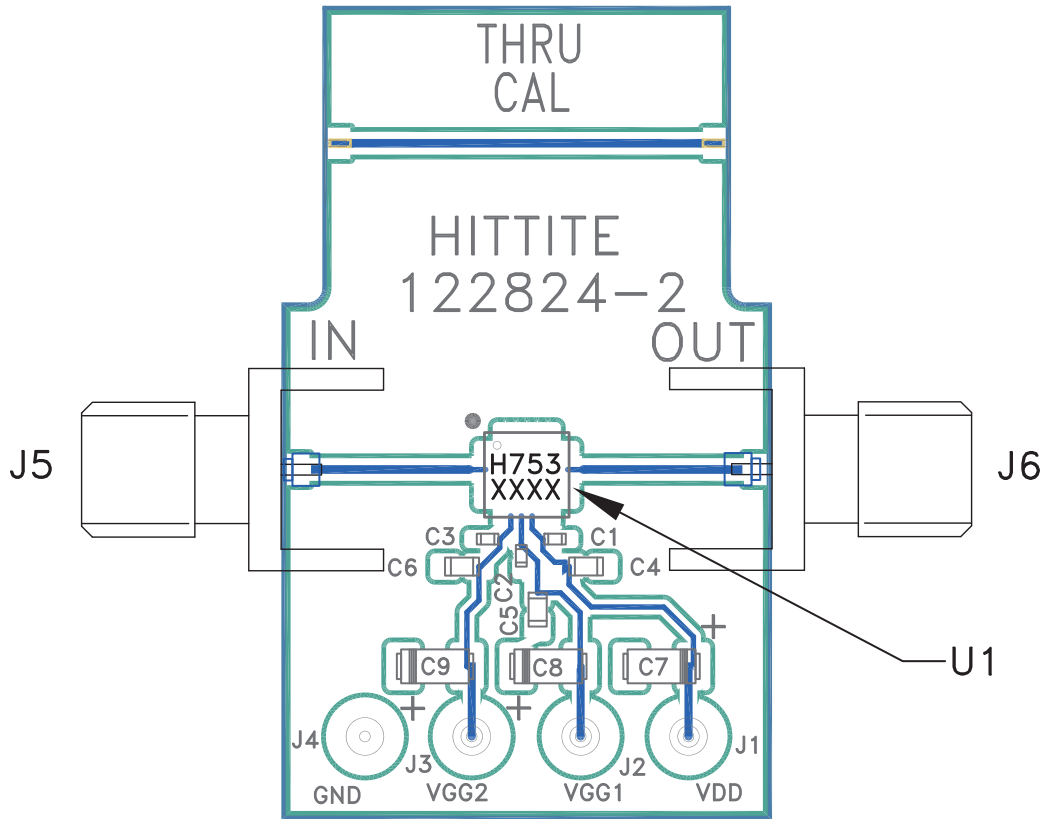

List of Materials for Evaluation PCB 122826 [1]

Item	Description
J1, J2	SMA Connector
J3 - J6	DC Pin
C1 - C3	100pF Capacitor, 0402 Pkg.
C4 - C6	10,000pF Capacitor, 0603 Pkg.
C7 - C9	4.7 µF Capacitor, Tantalum
U1	HMC753LP4E Amplifier
PCB [2]	122824 Evaluation PCB [3]

[1] Reference this number when ordering complete evaluation PCB

[2] Circuit Board Material: Rogers 4350 or Arlon 25FR

The circuit board used in this application should use RF circuit design techniques. Signal lines should have 50 Ohm impedance while the package ground leads and exposed paddle should be connected directly to the ground plane similar to that shown. A sufficient number of via holes should be used to connect the top and bottom ground planes. The evaluation board should be mounted to an appropriate heat sink. The evaluation circuit board shown is available from Hittite upon request.