

## FEATURES

- ◆ Footprint from 1.05cm<sup>2</sup>
- ◆ I/O isolation voltage 1000VDC
- ◆ Operating Temperature: -40°C ~ +85°C
- ◆ High efficiency up to 85%
- ◆ Fully encapsulated toroidal magnetics
- ◆ Internal SMD construction
- ◆ Custom solutions available
- ◆ No electrolytic or tantalum capacitors
- ◆ 5V, 9V, 12V and 15V output
- ◆ No heatsink required
- ◆ Pin compatible with B-X(S)D-1W series
- ◆ UL 94V-0 package material
- ◆ No external components required
- ◆ Industry standard pinout
- ◆ Power density 2.01W/cm<sup>3</sup>
- ◆ MTTF up to 2.3 million hours

## MODEL SELECTION

**B<sup>①</sup> 05<sup>②</sup> 05<sup>③</sup> X<sup>④</sup> M<sup>⑤</sup> -2W<sup>⑥</sup>**

- ① Product Series
- ② Input Voltage
- ③ Output Voltage
- ④ Fixed Input
- ⑤ Package Style
- ⑥ Rated Power

## APPLICATIONS

The B-XM-2W series of DC/DC Converters is particularly suited to isolating and/or converting DC power rails. The galvanic isolation allows the device to be configured to provide an isolated negative rail in systems where only positive rails exist. The wide temperature range guarantees startup from -40°C and full 2 watt output at 85°C. Pin compatibility with the B-X(S)D-1W ensures ease of upgradeability.



**CE REACH**

MICRODC reserves the copyright

## SELECTION GUIDE

Order code	Input Voltage (V)	Output Voltage (V)	Output Current (mA)	Input Current (Rated Load) (mA)	Efficiency (%)	Isolation Capacitance (PF)	MTTF <sup>1</sup> (KHRS)
B0505XM-2W	5	5	400	513	78	19	2327
B0509XM-2W	5	9	222	492	81	27	1393
B0512XM-2W	5	12	167	479	84	32	832
B0515XM-2W	5	15	133	481	83	27	481
B1205XM-2W	12	5	400	207	81	28	716
B1209XM-2W	12	9	222	198	84	42	593
B1212XM-2W	12	12	167	197	85	46	461
B1215XM-2W	12	15	133	197	85	54	328
B2405XM-2W	24	5	400	104	80	60	315
B2409XM-2W	24	9	222	100	83	65	302
B2412XM-2W	24	12	167	99	84	78	295
B2415XM-2W	24	15	133	99	84	58	282

## Input Characteristics

Parameter	Conditions	Min	Typ	Max.	Units
Voltage range	Continuous operation, 5V input types	4.5	5	5.5	V
	Continuous operation, 12V input types	10.8	12	13.2	
	Continuous operation, 24V input types	21.6	24	26.4	
Reflected ripple current	5V input types		33		mA p-p
	12V input types		38		mA p-p

## OUTPUT CHARACTERISTICS

Parameter	Conditions	Min	Typ.	Max.	Units
Rated Power	TA = -40° C to 85° C			2	W
Voltage Set Point Accuracy	See tolerance envelope				
Line regulation	High VIN to low VIN		1.0	1.2	%%
Load regulation 10% load to rated load	5V output		7	8.5	%
	9V output		4.5	5.2	%
	12V output		4.5	5.5	%
	15V output		3.7	8.5	%
Ripple and Noise	B0505XM, BW=DC to 20MHz		96	200	mA p-p
	B0509XM, BW=DC to 20MHz		67	200	mA p-p
	B0512XM, BW=DC to 20MHz		59	200	mA p-p
	B0515XM, BW=DC to 20MHz		53	200	mA p-p
	B1205XM, BW=DC to 20MHz		76	200	mA p-p
	B1209XM, BW=DC to 20MHz		63	200	mA p-p
	B1212XM, BW=DC to 20MHz		53	200	mA p-p
	B1215XM, BW=DC to 20MHz		45	200	mA p-p

## Absolute Maximum Ratings

Short-circuit protection <sup>2</sup>	1 second
Lead temperature 1.5mm from case for 10 seconds	300° C
Internal power dissipation	805mW
Input voltage VIN, B05 types	7V
Input voltage VIN, B12 types	15V
Input voltage VIN, B24 types	28V

## Isolation characteristics

Parameter	Conditions	Min.	Typ	Max.	Unit
Isolation test voltage	1 second	1000			VDC
Resistance	Viso = 500VDC	10			GΩ

1. Calculated using MIL-HDBK-217FN2 calculation model with nominal input voltage at full load.

2. Supply voltage must be disconnected at the end of the short circuit duration.

All specifications typical at TA = 25°C, nominal input voltage and rated output current unless otherwise specified.

### Minimum load

The minimum load to meet datasheet specification is 10% of the full rated load across the specified input voltage range. Lower than 10% minimum loading will result in an increase in output voltage, which may rise to typically double the specified output voltage if the output load falls to less than 5%.

### Capacitive loading and start up

Typical start up times for this series, with a typical input voltage rise time of 2.2s and output capacitance of 10F, are shown in the table below. The product series will start into a capacitance of 47F with an increased start time, however, the maximum recommended output capacitance is 10F.

	Start-up time	
	μs	
B0505XM	790	
B0509XM	1154	
B0512XM	2265	
B0515XM	2998	
B1205XM	396	
B1209XM	880	
B1212XM	1156	
B1215XM	2394	

### Typical Start-Up Wave Form

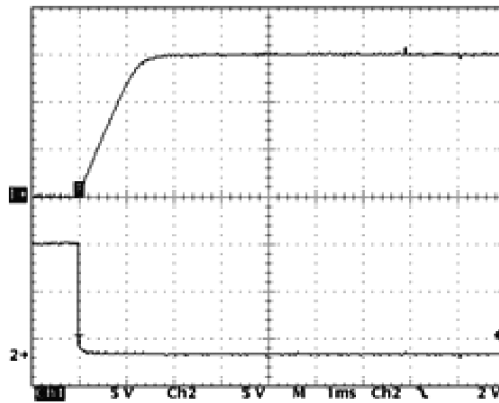

### General Characteristics

Parameter	Conditions	Min.	Typ.	Max.	Units
Switching frequency	5V input types		90		kHz
	12V input types		90		kHz

### Temperature Characteristics

Parameter	Conditions	Min.	Typ.	Max.	Units
Specification	All output types	-40		85	°C
Storage		-50		130	
Case temperature above ambient	5V output types			45	
	All other output types			36	
Cooling	Free air convection				

### Temperature derating graph

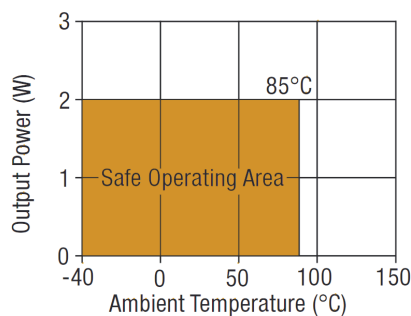

### Tolerance envelope

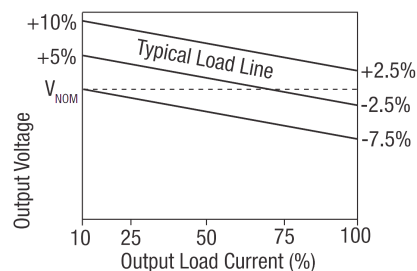

The voltage tolerance envelope shows typical load regulation characteristics for this product series. The tolerance envelope is the maximum output voltage variation due to changes in output loading.

### Technical notes

#### ISOLATION VOLTAGE

"Hi Pot Test", "Flash Tested", "Withstand Voltage", "Dielectric Withstand Voltage" & " Isolation Test Voltage" are all terms that relate to the same thing, a test voltage. Applied for a specified time, across a component designed to provide electrical isolation, to verify the integrity of that isolation. Professional Power Module B-XM series of DC/DC converters are all 100% production tested at their stated isolation voltage. This is 1KVDC for 1 second.

A question commonly asked is, "What is the continuous voltage that can be applied across the part in normal operation?"

The B-XM-2W series has been recognized by Underwriters Laboratory for functional insulation. Both input and output should normally be maintained within SELV limits i.e. less than 42.4V peak, or 60VDC. The isolation test voltage represents a measure of immunity to transient voltages and the part should never be used as an element of a safety isolation system. The part could be expected to function correctly with several hundred volts offset applied continuously across the isolation barrier, but then the circuitry on both sides of the barrier must be regarded as operating at an unsafe voltage and further isolation/insulation systems must form a barrier between these circuits and any user-accessible circuitry according to safety standard requirements.

#### REPEATED HIGH-VOLTAGE ISOLATION TESTING

It is well known that repeated high-voltage isolation testing of a barrier component can actually degrade isolation capability, to a lesser or greater degree depending on materials. Construction and environment. The B-XM series has toroidal isolation transformers, with no additional insulation between primary and secondary windings of enameled wire. While parts can be expected to withstand several times the stated test voltage, the isolation capability does depend on the wire insulation. Any material, including this enamel (typically polyurethane) is susceptible to eventual chemical degradation when subject to very high applied voltages thus implying that the number of tests should be strictly limited. We therefore strongly advise against repeated high voltage isolation testing, but if it is absolutely required, that the voltage be reduced by 20% from specified test voltage.

This consideration equally applies to agency recognized parts for better than functional isolation where the wire enamel insulation is always supplemented by a further insulation system of physical spacing or barriers.

### OUTPUT RIPPLE REDUCTION

#### Output ripple reduction

By using the values of inductance and capacitance stated, the output ripple at the rated load is lowered to 5mV p-p max.

#### Component selection

Capacitor: Ceramic chip capacitors are recommended. It is required that the ESR(Equivalent Series Resistance) should be as low as possible. X7R types are recommended.

The voltage rating should be at least twice(except for 15V output), the rated output voltage of the DC/DC converter.

Inductor: The rated current of the inductor should not be less than of the output of the DC/DC converter. At the rated current, the DC resistance of the inductor should be such that the voltage drop across the inductor is <2% of the rated voltage of the DC/DC converter. The SRF(Self Resonant Frequency) should be >20MHz.

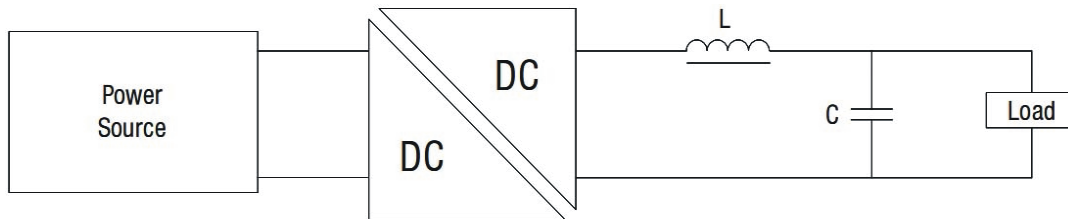

### CHARACTERISATION TEST METHODS

#### Ripple & Noise Characterisation Method

Ripple and noise measurements are performed with the following test configuration.

C1	1 $\mu$ F X7R multilayer ceramic capacitor, voltage rating to be a minimum of 3 times the output voltage of the DC/DC converter
C2	10 $\mu$ F tantalum capacitor, voltage rating to be a minimum of 1.5 times the output voltage of the DC/DC converter with an ESR of less than 100m $\Omega$ at 100 KHz
C3	100nF multilayer ceramic capacitor, general purpose
R1	450 $\Omega$ resistor, carbon film, $\pm$ 1% tolerance
R2	50 $\Omega$ BNC termination
T1	3T of the coax cable through a ferrite toroid
RLOAD	Resistive load to the maximum power rating of the DC/DC converter. Connections should be made via twisted wires

Measured values are multiplied by 10 to obtain the specified values.

#### Differential Mode Noise Test Schematic

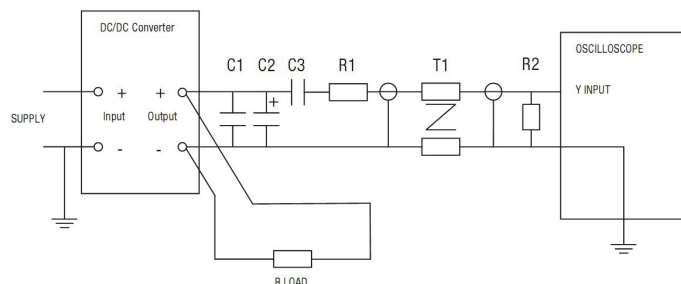

### PACKAGE SPECIFICATIONS

#### MECHANICAL DIMENSIONS

##### SIP Package

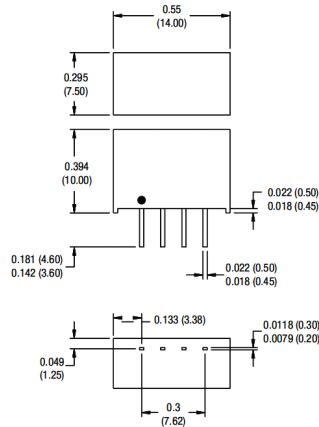

All dimensions in inches  $\pm 0.01$  (mm  $\pm 0.25$ mm).

All pins on a 0.1(2.54) pitch and within  $\pm 0.01$ (0.25)of true position.

Weight: 2.0g

#### FOOTPRINT DETAILS

##### PIN CONNECTIONS-4 PIN SIP

PIN	Function	"N" SUFFIX
1	-Vin	+Vin
2	+Vin	-Vin
3	-Vout	-Vout
4	+Vout	+Vout

Specifications can be changed any time without notice.

No parallel connection or plug and play.

Note:

1. The load shouldn't be less than 10%, otherwise ripple will increase dramatically.
2. Operation under 10% load will not damage the converter; However, they may not meet all specification listed.
3. All specifications measured at Ta=25°C, humidity<75%, nominal input voltage and rated output load unless otherwise specified.
4. In this datasheet, all the test methods of indications are based on corporate standards.

#### RECOMMENDED FOOTPRINT DETAILS

##### 4 Pin SIP Package

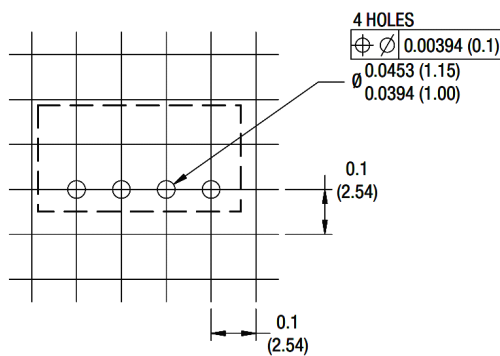

Unless otherwise stated all dimensions in inches (mm)  $\pm 0.5$ mm.

#### TUBE OUTLINE DIMENSIONS

##### 4 PIN SIP Tube

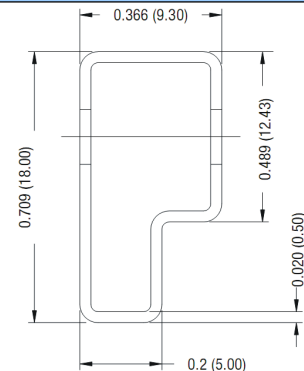

Unless otherwise stated all dimensions in inches (mm)  $\pm 0.5$ mm.

Tube length (4 Pin SIP) : 20.47 (520mm  $\pm 2$ mm).

Tube Quantity :35