

To all our customers

Regarding the change of names mentioned in the document, such as Mitsubishi Electric and Mitsubishi XX, to Renesas Technology Corp.

The semiconductor operations of Hitachi and Mitsubishi Electric were transferred to Renesas Technology Corporation on April 1st 2003. These operations include microcomputer, logic, analog and discrete devices, and memory chips other than DRAMs (flash memory, SRAMs etc.) Accordingly, although Mitsubishi Electric, Mitsubishi Electric Corporation, Mitsubishi Semiconductors, and other Mitsubishi brand names are mentioned in the document, these names have in fact all been changed to Renesas Technology Corp. Thank you for your understanding. Except for our corporate trademark, logo and corporate statement, no changes whatsoever have been made to the contents of the document, and these changes do not constitute any alteration to the contents of the document itself.

Note : Mitsubishi Electric will continue the business operations of high frequency & optical devices and power devices.

Renesas Technology Corp.
Customer Support Dept.
April 1, 2003

FL16KM-6A

HIGH-SPEED SWITCHING USE

FL16KM-6A

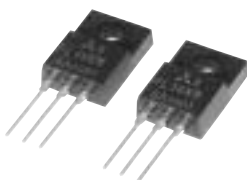

- 10V DRIVE
- V_{DSS} 300V
- r_{DS (ON)} (MAX) 0.35Ω
- I_D 16A

OUTLINE DRAWING Dimensions in mm

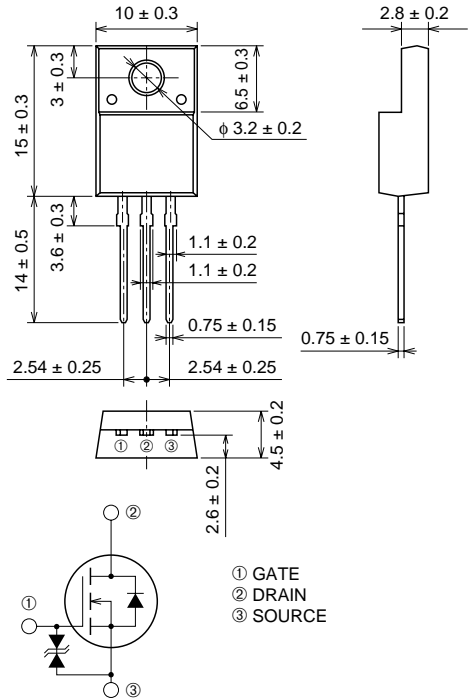

TO-220FN

APPLICATION

SMPS, Inverter fluorescent light sets, etc.

MAXIMUM RATINGS (T_c = 25°C)

Symbol	Parameter	Conditions	Ratings	Unit
V _{DSS}	Drain-source voltage	V _{GS} = 0V	300	V
V _{GSS}	Gate-source voltage	V _{DS} = 0V	±30	V
I _D	Drain current		16	A
I _{DM}	Drain current (Pulsed)		48	A
I _{DA}	Avalanche drain current (Pulsed)	L = 200μH	16	A
P _D	Maximum power dissipation		35	W
T _{ch}	Channel temperature		-55 ~ +150	°C
T _{stg}	Storage temperature		-55 ~ +150	°C
V _{iso}	Isolation voltage	AC for 1minute, Terminal to case	2000	V
—	Weight	Typical value	2.0	g

FL16KM-6A

HIGH-SPEED SWITCHING USE

ELECTRICAL CHARACTERISTICS (Tch = 25°C)

Symbol	Parameter	Test conditions	Limits			Unit
			Min.	Typ.	Max.	
V (BR) DSS	Drain-source breakdown voltage	ID = 1mA, VGS = 0V	300	—	—	V
V (BR) GSS	Gate-source breakdown voltage	IGS = ±100μA, VDS = 0V	±30	—	—	V
IGSS	Gate-source leakage current	VGS = ±25V, VDS = 0V	—	—	±10	μA
IDSS	Drain-source leakage current	VDS = 300V, VGS = 0V	—	—	1	mA
VGS (th)	Gate-source threshold voltage	ID = 1mA, VDS = 10V	2.0	3.0	4.0	V
rDS (ON)	Drain-source on-state resistance	ID = 8A, VGS = 10V	—	0.29	0.35	Ω
VDS (ON)	Drain-source on-state voltage	ID = 8A, VGS = 10V	—	2.32	2.80	V
yfs	Forward transfer admittance	ID = 8A, VDS = 10V	—	10	—	S
Ciss	Input capacitance	VDS = 25V, VGS = 0V, f = 1MHz	—	950	—	pF
Coss	Output capacitance		—	175	—	pF
Crss	Reverse transfer capacitance		—	20	—	pF
td (on)	Turn-on delay time	VDD = 150V, ID = 8A, VGS = 10V, RGEN = RGS = 50Ω	—	15	—	ns
tr	Rise time		—	30	—	ns
td (off)	Turn-off delay time		—	150	—	ns
tf	Fall time		—	60	—	ns
VSD	Source-drain voltage	IS = 8A, VGS = 0V	—	1.5	2.0	V
Rth (ch-c)	Thermal resistance	Channel to case	—	—	3.57	°C/W

PERFORMANCE CURVES

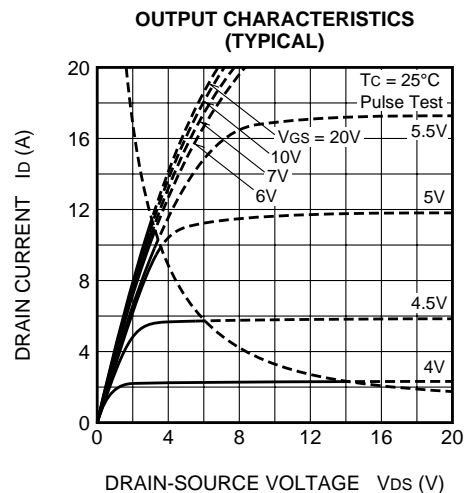
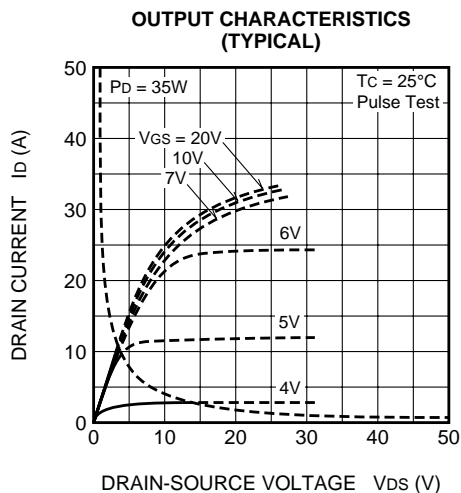
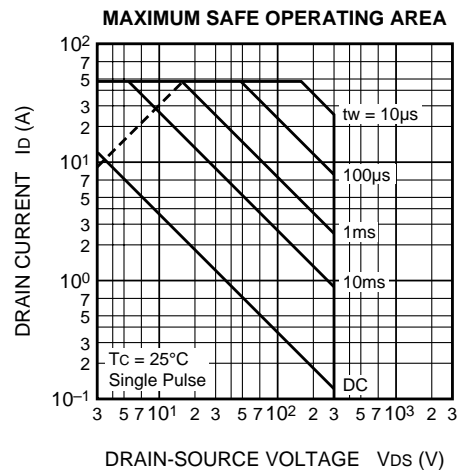
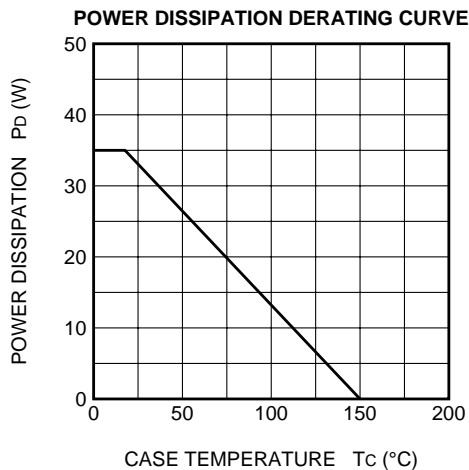

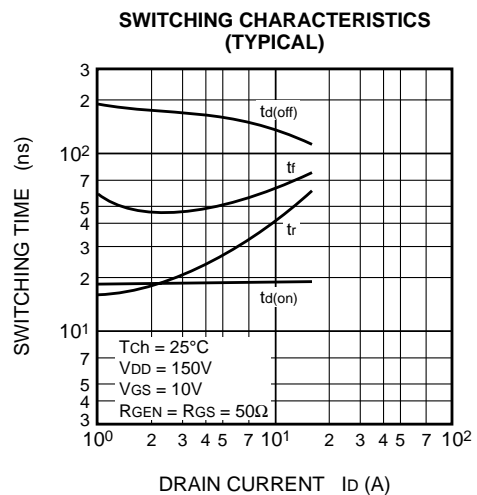
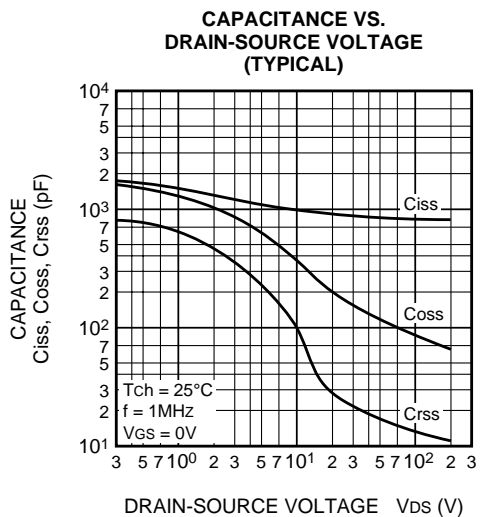
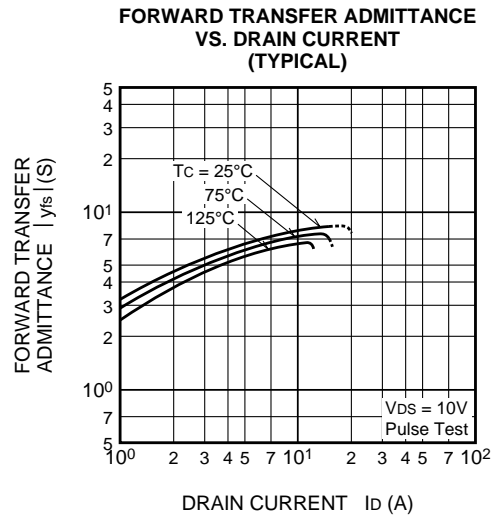
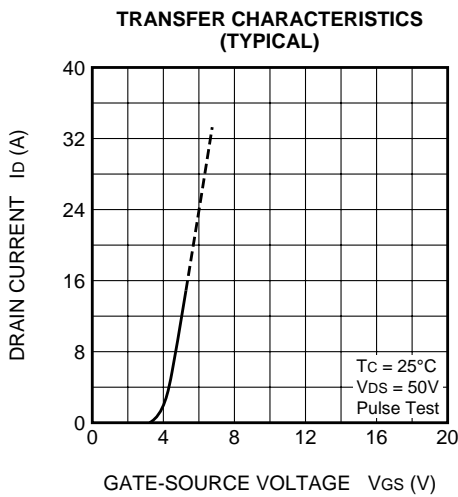
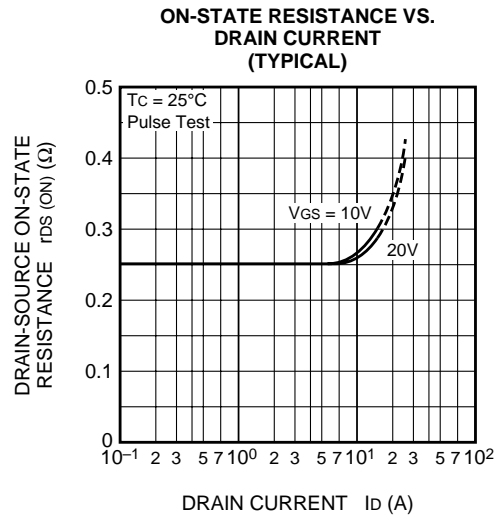
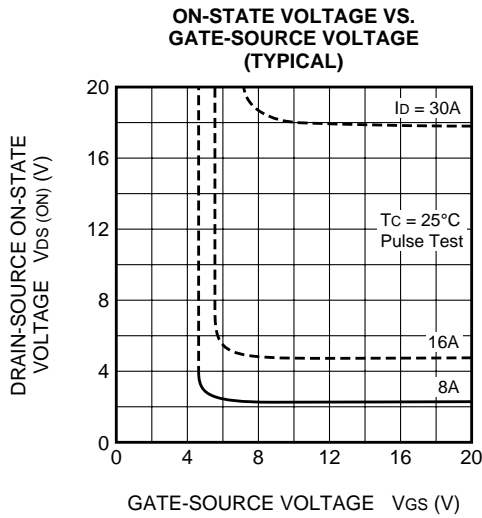

GATE-SOURCE VOLTAGE VS. GATE CHARGE (TYPICAL)

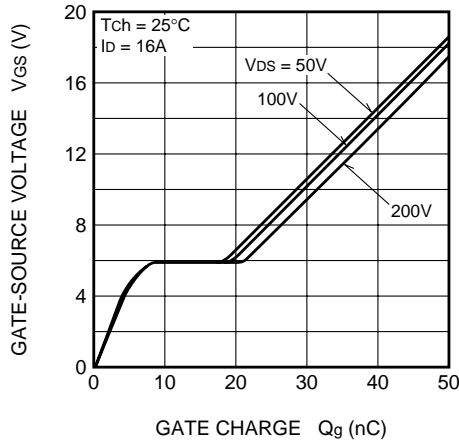

SOURCE-DRAIN DIODE FORWARD CHARACTERISTICS (TYPICAL)

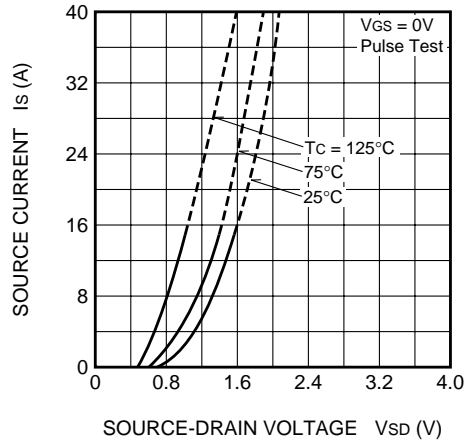

ON-STATE RESISTANCE VS. CHANNEL TEMPERATURE (TYPICAL)

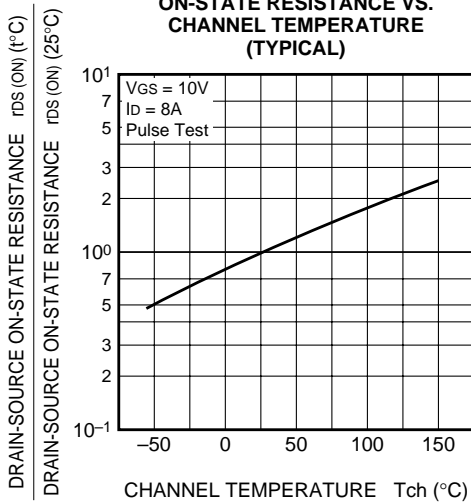

THRESHOLD VOLTAGE VS. CHANNEL TEMPERATURE (TYPICAL)

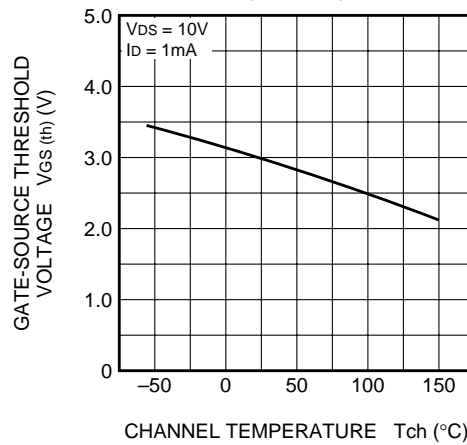

BREAKDOWN VOLTAGE VS. CHANNEL TEMPERATURE (TYPICAL)

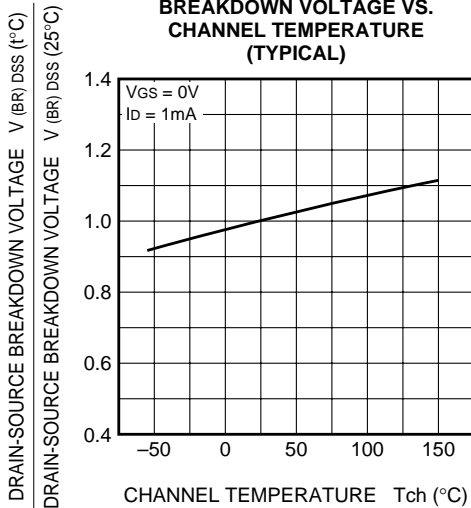

TRANSIENT THERMAL IMPEDANCE CHARACTERISTICS

