

PLEASE CHECK WWW.MOLEX.COM FOR LATEST PART INFORMATION

Part Number: [0430450810](#)

Status: **Active**

Overview: [microfit 30](#)

Description: 3.00mm (.118") Pitch Micro-Fit 3.0™ Header, Surface Mount, Dual Row, Right Angle, with Solder Tab, 8 Circuits, 0.38µm (15µ") Gold (Au) Selective Plating, Glow Wire Compatible

Documents:

[3D Model](#)

[Drawing \(PDF\)](#)

[Product Specification PS-43045 \(PDF\)](#)

[RoHS Certificate of Compliance \(PDF\)](#)

Agency Certification

CSA	LR19980
TUV	R72081037
UL	E29179

General

Product Family	PCB Headers
Series	43045
Application	Wire-to-Board
Comments	Glow Wire Equivalent Part Number 430450810 . High Temperature, Square Pin, Solder Type
Overview	microfit 30
Product Literature Order No	USA-106
Product Name	Micro-Fit 3.0™

Physical

Breakaway	No
Circuits (Loaded)	8
Circuits (maximum)	8
Color - Resin	Black
Durability (mating cycles max)	30
Flammability	94V-0
Glow-Wire Compliant	Yes
Mated Height (in)	0.405 In
Mated Height (mm)	10.29 mm
Material - Metal	Brass
Material - Plating Mating	Gold
Material - Plating Termination	Tin
Material - Resin	High Temperature Thermoplastic
Number of Rows	2
Orientation	Right Angle
PCB Locator	Yes
PCB Retention	Yes
PCB Thickness Recommended (in)	0.062 In
PCB Thickness Recommended (mm)	1.60 mm
Packaging Type	Embossed Tape on Reel
Pitch - Mating Interface (in)	0.118 In
Pitch - Mating Interface (mm)	3.00 mm
Plating min: Mating (µin)	15
Plating min: Mating (µm)	0.38
Plating min: Termination (µin)	100
Plating min: Termination (µm)	2.50
Polarized to PCB	Yes
Shrouded	Fully
Stackable	No

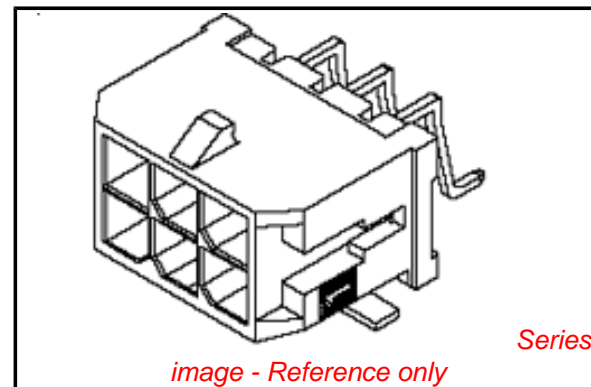

image - Reference only

EU RoHS

ELV and RoHS Compliant

REACH SVHC

Contains SVHC: No

Halogen-Free

Status

Halogen-Free

China RoHS



Need more information on product environmental compliance?

Email productcompliance@molex.com
For a multiple part number RoHS Certificate of Compliance, [click here](#)

Please visit the [Contact Us](#) section for any non-product compliance questions.

Search Parts in this Series

[43045Series](#)

Mates With

[43025](#)

Surface Mount Compatible (SMC)	N/A
Temperature Range - Operating	-40°C to +105°C
Termination Interface: Style	Surface Mount

Electrical

Current - Maximum per Contact	5A
Voltage - Maximum	250V

Solder Process Data

Duration at Max. Process Temperature (seconds)	30
Lead-free Process Capability	Reflow Capable (SMT only)
Max. Cycles at Max. Process Temperature	3
Process Temperature max. C	260

Material Info

Reference - Drawing Numbers

Packaging Specification	PK-70873-05**
Product Specification	PS-43045, RPS-43045-003, RPS-43045-004
Sales Drawing	SD-43045-004
Test Summary	TS-43045-001, TS-43045-002

This document was generated on 05/24/2010

PLEASE CHECK WWW.MOLEX.COM FOR LATEST PART INFORMATION

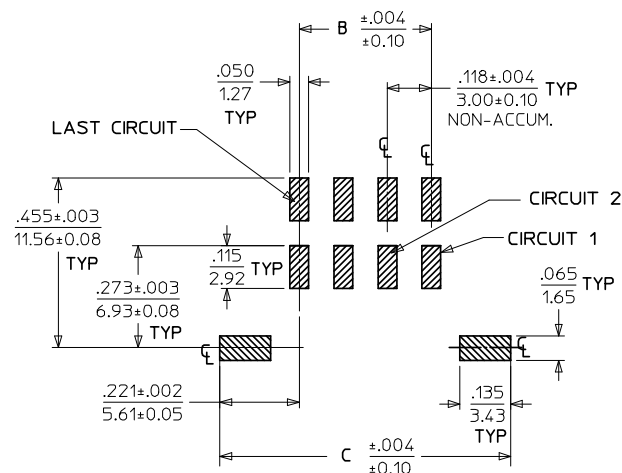
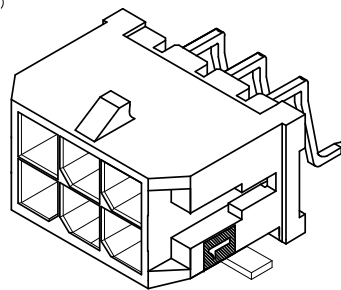
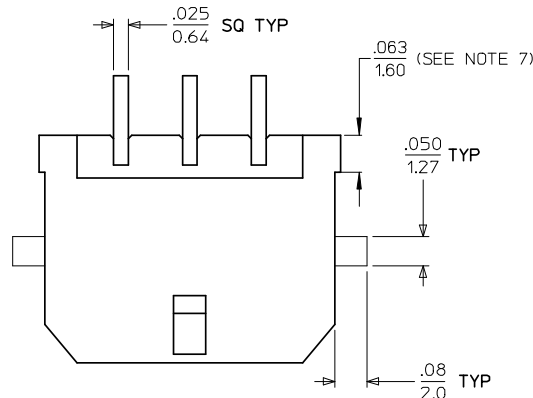

PCB LAYOUT: COMPONENT SIDE

CIRCUIT "1" IDENTIFIED ON THIS SURFACE (APPROX. LOCATION SHOWN FOR REF.)

CKTS	A (SEE NOTE 7)	B	C
02	.262 6.65	NA	.441 11.20
04	.380 9.65	.118 3.00	.559 14.20
06	.498 12.65	.236 6.00	.677 17.20
08	.616 15.65	.354 9.00	.795 20.20
10	.734 18.65	.472 12.00	.913 23.20
12	.852 21.65	.591 15.00	1.031 26.20
14	.970 24.65	.709 18.00	1.150 29.20
16	1.088 27.65	.827 21.00	1.268 32.20
18	1.206 30.65	.945 24.00	1.386 35.20
20	1.325 33.65	1.063 27.00	1.504 38.20
22	1.443 36.65	1.181 30.00	1.622 41.20
24	1.561 39.65	1.299 33.00	1.740 44.20

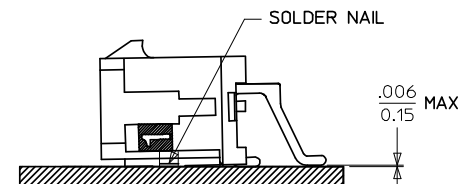
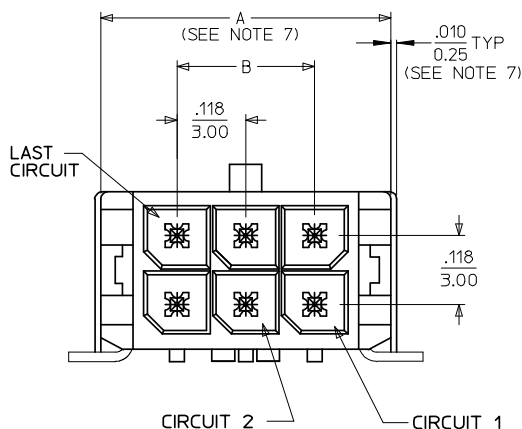

COPLANARITY DETAIL (SEE NOTE #6)

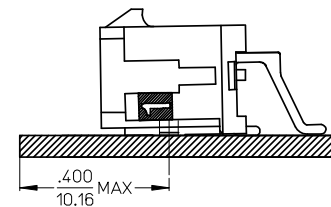

LOCATION DETAIL (SEE NOTE #8)

NOTES:

- HOUSING MATERIAL: GLASS FILLED LIQUID CRYSTAL POLYMER, UL94V-0, COLOR: BLACK
TERMINAL MATERIAL: BRASS ALLOY
- FINISH: A = .000100/(0.00254) MIN. TIN OVER
.000050/(0.00127) MIN. NICKEL PLATE.
B = .000015/(0.00038) MIN. GOLD IN SELECTIVE AREA,
.000100/(0.00254) MIN. MATTE TIN ON SOLDER TAILS,
BOTH OVER .000050/(0.00127) MIN. NICKEL PLATE.
C = .000030/(0.00076) MIN. GOLD IN SELECTIVE AREA,
.000100/(0.00254) MIN. MATTE TIN ON SOLDER TAILS,
BOTH OVER .000050/(0.00127) MIN. NICKEL PLATE.
* THE PRIMARY SHIPPING CARTON WILL BE LABELED "COMPLIANT TO RoHS DIRECTIVE 2002/95/EC AND ELV ANNEX II OF DIRECTIVE 2000/53/EC." CARTONS WITHOUT THIS LABEL MAY CONTAIN PRODUCT WITH TIN/LEAD IN THE PC TAIL AREA.
- PRODUCT SPECIFICATION: PS-43045
- TAPE AND REEL PACK: SEE MOLEX DRAWING PK-70873-05**
- MATES WITH MOLEX RECEPTACLE SERIES 43025
- THE COPLANARITY DIMENSION IS ESTABLISHED BY PLACING THE ASSEMBLY ON A FLAT SURFACE. THE DISTANCE FROM THAT SURFACE TO THE BOTTOM OF ANY TERMINAL OR NAIL MUST NOT EXCEED .006/0.15
- .010/0.25 OFFSETS ARE PRESENT ON ALL PARTS MANUFACTURED AFTER 11/1/2007, AND ON PARTS PRIOR TO 11/1/2007 THAT CONTAIN A GREEN DOT ON THE PRIMARY SHIPPING CARTON LABEL.
- TO AVOID INTERFERENCE BETWEEN RECEPTACLE AND PCB, HEADER MUST BE PLACED WITHIN .400/(10.16) MAX. FROM EDGE OF PCB, AS SHOWN IN LOCATION DETAIL.
- THIS PART CONFORMS TO CLASS B REQUIREMENTS OF COSMETIC SPECIFICATION PS-45499-002.

	FINISH A	FINISH B	FINISH C
CKTS	MATERIAL NO:	MATERIAL NO:	MATERIAL NO:
02	43045-0209	43045-0210	43045-0211
04	43045-0409	43045-0410	43045-0411
06	43045-0609	43045-0610	43045-0611
08	43045-0809	43045-0810	43045-0811
10	43045-1009	43045-1010	43045-1011
12	43045-1209	43045-1210	43045-1211
14	43045-1409	43045-1410	43045-1411
16	43045-1609	43045-1610	43045-1611
18	43045-1809	43045-1810	43045-1811
20	43045-2009	43045-2010	43045-2011
22	43045-2209	43045-2210	43045-2211
24	43045-2409	43045-2410	43045-2411

LOCATION DETAIL EC NO: UCP2008-0324 DRW: NIKI PPER 2007/12/19 CHKD: SSOUSEK 2007/12/20 APPR: FSMITH 2007/12/21	QUALITY SYMBOLS ▽=0 ▽=0	GENERAL TOLERANCES (UNLESS SPECIFIED) 4 PLACES ± --- ± --- 3 PLACES ± --- ± .010 2 PLACES ± 0.25 ± .014 1 PLACE ± 0.36 ± --- ANGULAR ±1/2°	DIMENSION STYLE IN/MM	DRAWN BY DATE SAMIEC 2000/03/15 CHECKED BY DATE MUELLER 2000/03/15 APPROVED BY DATE EDGLEY 2000/03/15	SCALE --- DESIGN UNITS METRIC THIRD ANGLE PROJECTION	TITLE MICRO FIT (3.0) DUAL ROW RIGHT ANGLE SMT HEADER W/NAI LS ASSY	MOLEX MOLEX INCORPORATED	DOCUMENT NO. SD-43045-004	SHEET NO. 1 OF 1			
										DRAFT WHERE APPLICABLE MUST REMAIN WITHIN DIMENSIONS	SEE CHART	THIS DRAWING CONTAINS INFORMATION THAT IS PROPRIETARY TO MOLEX INCORPORATED AND SHOULD NOT BE USED WITHOUT WRITTEN PERMISSION
										MOLEX MOLEX INCORPORATED		
										SD-43045-004		