

HITACHI

Hitachi Displays, Ltd.

Date: Oct. 20, 2005

For Messrs. Hitachi Europe Ltd.
CUSTOMER'S ACCEPTANCE SPECIFICATIONS

TX26D02VM1CAA

CONTENTS

No.	Item	Sheet No.	Page
-	COVER	3284PS 2601-TX26D02VM1CAA-2	1-1/1
-	RECORD OF REVISION	3284PS 2602-TX26D02VM1CAA-2	2-1/1
-	APPLICATION	3284PS 2603-TX26D02VM1CAA-2	3-1/1
1	ABSOLUTE MAXIMUM RATINGS	3284PS 2604-TX26D02VM1CAA-2	4-1/2-2/2
2	OPTICAL CHARACTERISTICS	3284PS 2605-TX26D02VM1CAA-2	5-1/2-2/2
3	ELECTRICAL CHARACTERISTICS	3284PS 2606-TX26D02VM1CAA-2	6-1/1
4	BLOCK DIAGRAM	3284PS 2607-TX26D02VM1CAA-2	7-1/1
5	INTERFACE PIN CONNECTION	3284PS 2608-TX26D02VM1CAA-2	8-1/2-2/2
6	INTERFACE TIMING	3284PS 2609-TX26D02VM1CAA-2	9-1/3-3/3
7	DIMENSIONAL OUTLINE	3284PS 2610-TX26D02VM1CAA-2	10-1/2-2/2
8	DESIGNATION OF LOT MARK	3284PS 2611-TX26D02VM1CAA-2	11-1/2-2/2
9	COSMETIC SPECIFICATIONS	3284PS 2612-TX26D02VM1CAA-2	12-1/3-3/3
10	PRECAUTIONS	3284PS 2613-TX26D02VM1CAA-2	13-1/4-4/4
-	-	-	-

Please return 1 copy with your signature on this page for approval.

Accepted by : _____

Proposed by : 

Date : _____

CAS-S05-182

Hitachi Displays, Ltd.	Sh. No.	3284PS 2601-TX26D02VM1CAA-2	Page 1-1/1
------------------------	------------	-----------------------------	------------

RECORD OF REVISION

Date	Old Sheet No.	Summary
	New Sheet No.	
Oct. 20, 2005	3284PS 2603- TX26D02VM1CAA-1 Page 3-1/1	Added : APPLICATION
	3284PS 2603- TX26D02VM1CAA-2 Page 3-1/1	
	3284PS 2604- TX26D02VM1CAA-1 Page 4-1/2	Changed : 1.1 ENVIRONMENTAL ABSOLUTE MAXIMUM RATINGS
	3284PS 2604- TX26D02VM1CAA-2 Page 4-1/2	
	3284PS 2605- TX26D02VM1CAA-1 Page 5-1/2	Changed : 2. OPTICAL CHARACTERISTICS
	3284PS 2605- TX26D02VM1CAA-2 Page 5-1/2	
	3284PS 2613- TX26D02VM1CAA-1 Page 13-2/4	Changed : 10.2 OPERATING PRECAUTION
	3284PS 2613- TX26D02VM1CAA-2 Page 13-2/4	

APPLICATION

<26cm (10.4 inch) VGA>

In the case of applying this product for such as control and safety device of transportation facilities (airplane, train, automobile, ship, etc), equipments aiming for rescue and security, and the other safety related devices which should secure higher reliability and safety, please make it sure that proper countermeasure such as fail-safe functions and enough system design for the protection are mandatory.

Please do not apply this product for equipments or devices which need exceedingly high reliability, such as aerospace applications, telecommunication facilities (trunk lines), nuclear related equipments or plants, and critical life support devices or applications.

This specification is applied to the following TFT Liquid Crystal Display Module with Back-light unit.

Note : Inverter device for Back-light is not built in and so it needs to be prepared on yourside.

- Type name : TX26D02VM1CAA
- Display Area : H211.2×V158.4 [mm]
- Display Dots : H(640×3)×V480 [dots]
(Display Pixels) (H640×V480 pixels)
- Resolution : VGA
- Voltage of VDD : 3.3V
- Pixel Pitch : H0.330×V0.330 [mm]
- Color Pixel Arrangement : R·G·B Vertical Stripe
- Display Mode : Transmissive &
Normally White Mode
- Color Number : 262k Colors
- Dimensions Outlines : H243.0 TYP.×V181.6 TYP.×t12.5 MAX. [mm]
- Weight : (450)TYP. [g]
- Interface : CMOS
- Surface Polarizing Film : Anti-Glare Polarizing Film
(Hard Coat 3H:Pencil Hardness)
- Back-light : Two Cold Cathode Fluorescent Lamp
(Side-Light type:Both Long Side)
Back-light inverter is not
contained in Module.

1. ABSOLUTE MAXIMUM RATINGS

1.1 ENVIRONMENTAL ABSOLUTE MAXIMUM RATINGS

ITEM	OPERATING		STORAGE		UNIT	NOTE
	MIN.	MAX.	MIN.	MAX.		
Ambient Temperature	-20	70	-20	70	°C	1)
Humidity	2)		2)		%RH	1)
Vibration	—	9.8 (1G)	—	29.4 (3G)	m/s ²	3)
Shock	—	29.4 (3G)	—	980 (100G)		4)
Corrosive Gas	NOT ACCEPTABLE		NOT ACCEPTABLE		—	
Illuminance at LCD surface	—	50,000	—	50,000	lx	

Note 1) Environmental temperature and humidity of this unit, not of system installed with this unit.

Operating temperature means functional temperature without regard to optical performance.

Life characteristic is specified at 25±5 degree.

At low temperature the brightness of CFL drop and the life time of CFL become to be short (especially below 0 degree)

- 2) Ambient temp. $T_a \leq 40^\circ\text{C}$: 85%RH MAX. without condensation
 $T_a > 40^\circ\text{C}$: Absolute humidity must be lower than the saturated vapor of 85%RH at 40°C. without condensation
- 3) Vibration frequency : 20~50Hz. (Except resonance frequency)
- 4) 7ms of pulse width.

1.2 ELECTRICAL ABSOLUTE MAXIMUM RATINGS

(1) TFT LIQUID CRYSTAL DISPLAY MODULE

V_{SS}=0V

ITEM	SYMBOL	MIN.	MAX.	UNIT	NOTE
Power Supply Voltage	VDD	0	4.0	V	
Input signal Voltage for logic	V _I	-0.2	VDD+0.2	V	1)
Electrostatic Durability	VESD0	±100		V	2), 3)
	VESD1	± 8		kV	2), 4)

- Note 1) The specification shall be applied to pixel data signal and clock signal.
- 2) Discharge circuit to be connected : 200pF-250Ω, Environmental : 25°C-70%RH
- 3) The specification shall be applied to I/F connector pins.
- 4) The specification shall be applied to the surface of both a metal bezel and a LCD panel.

(2) BACK-LIGHT UNIT

GND=0V

ITEM	SYMBOL	MIN.	MAX.	UNIT	NOTE
Lamp Current	IL	0	7.0	mArms	1)
Lamp Voltage	VL	0	1800	V _{rms}	2)

- Note 1) At Lamp start-up time.
- 2) The specification is applicable to connector pins of Back-Light unit.

Adding protective spacer at shock & vibration test
 Shaded area is to be supported with additional spacer.

(1) This protective spacer is to be added at shock and vibration test on the front side

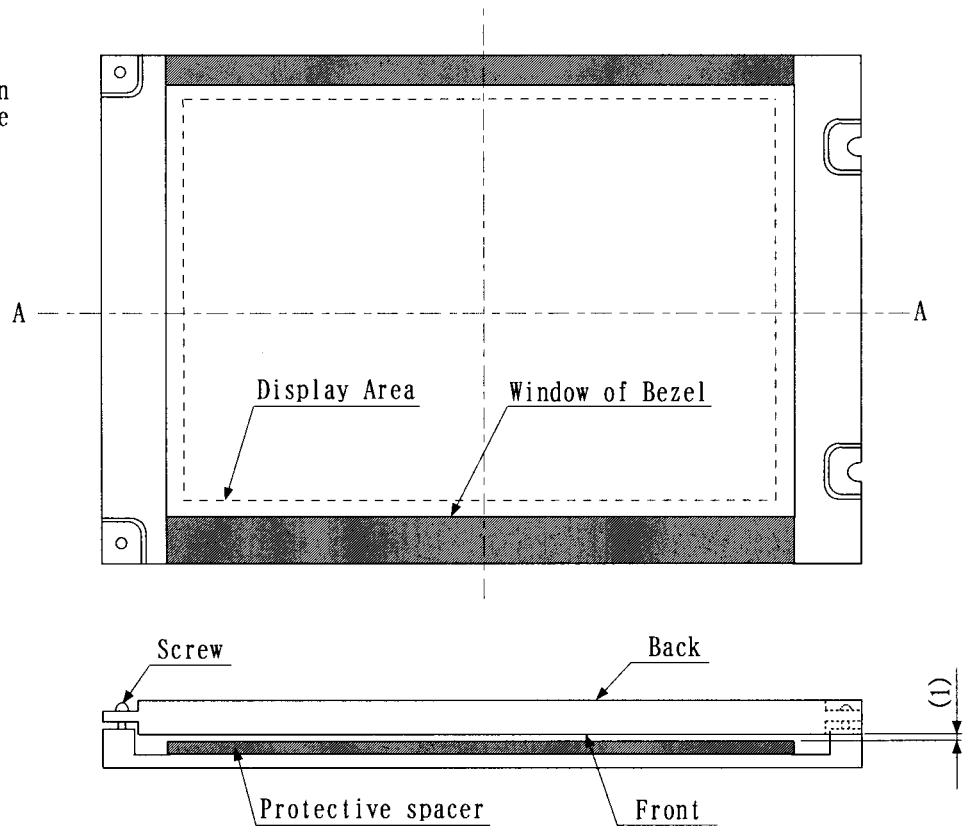

(2) This protective spacer is to be added shock and vibration test on the back side

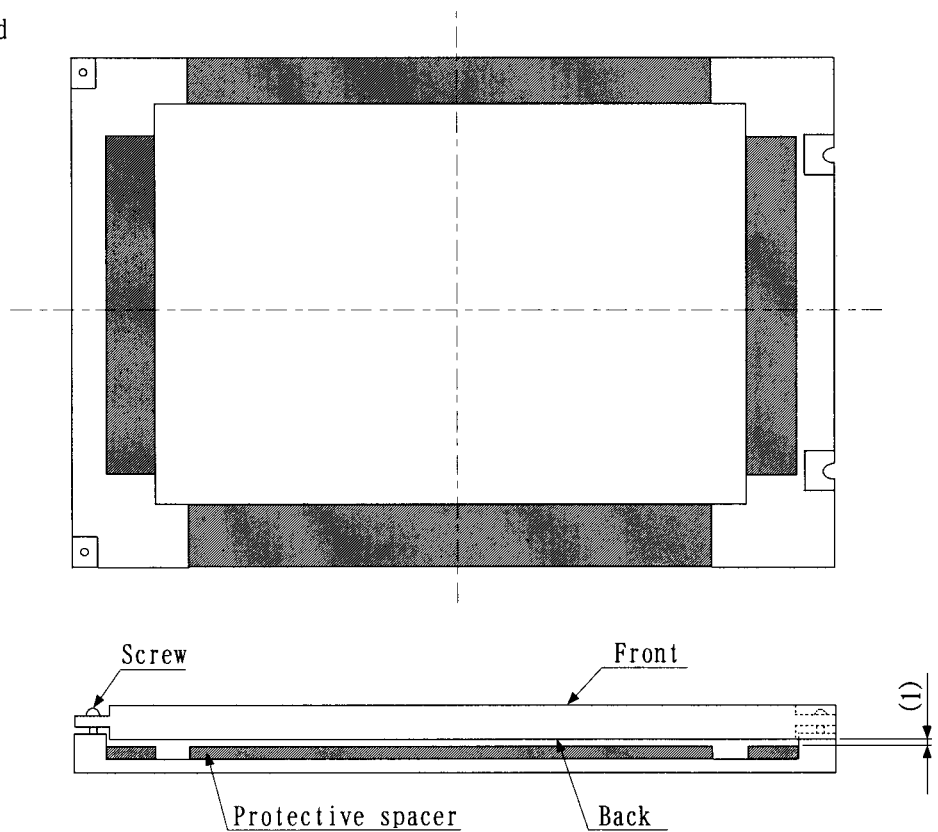

2. OPTICAL CHARACTERISTICS

We can guarantee only initial characteristics.

The following items are measured on the conditions that this unit operation (TFT panel and Back-light) and measuring systems are stable. (more than 15minutes' operation)

The ambient light excluding The Back-light unit is nothing.

- Measuring equipment : TOPCON BM-7, Prichard 1980A, or equivalent
- Measuring point : Active area center

Temperature of LCD=25°C, V_{DD}=3.3V, f_v=60Hz, I_L=6.0mA,
Back-Light operation Frequency=50kHz

ITEM	SYMBOL	CONDITION	MIN.	TYP.	MAX.	UNIT	NOTE	
Contrast Ratio	CR		200	500	—	—	2)	
Response Time	RISE	tr	—	30	—	ms	3)	
	FALL	tf	—	20	—			
Brightness (White)	Bwh		—	350	—	cd/m ²		
Brightness Uniformity	Buni		60	—	—	%	4)	
Color of CIE	Red	x	$\theta = 0^\circ$ Note 1)	0.59	0.63	0.67	—	
		y		0.30	0.34	0.38		
	Green	x		0.28	0.32	0.36		
		y		0.55	0.59	0.63		
	Blue	x		0.10	0.14	0.18		
		y		0.05	0.09	0.13		
	White	x		0.28	0.32	0.36		
		y		0.29	0.33	0.37		
Viewing Angle (CR \geq 10)	x-x	θx	$\phi = 0^\circ$	50	—	—	deg	
		$\theta x'$	$\phi = 180^\circ$	50	—	—		
	y-y	θy	$\phi = 90^\circ$	50	—	—		
		$\theta y'$	$\phi = 270^\circ$	50	—	—		

Note 1) Definition of Viewing Angle

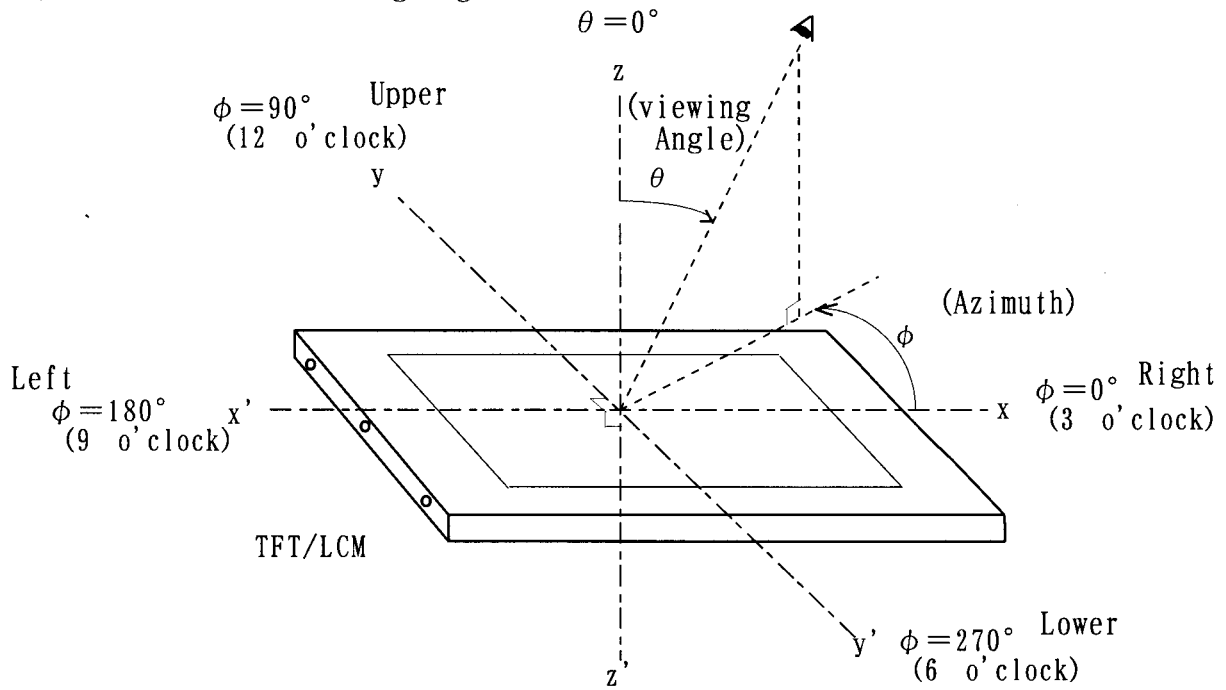

Note 2) Definition of Contrast Ratio (CR)

$$CR = \frac{\text{Brightness when displaying White raster}}{\text{Brightness when displaying Black raster}}$$

These Brightness is measured on the center of screen.
 * Measurement in the darkroom.

Note 3) Definition of Response Time

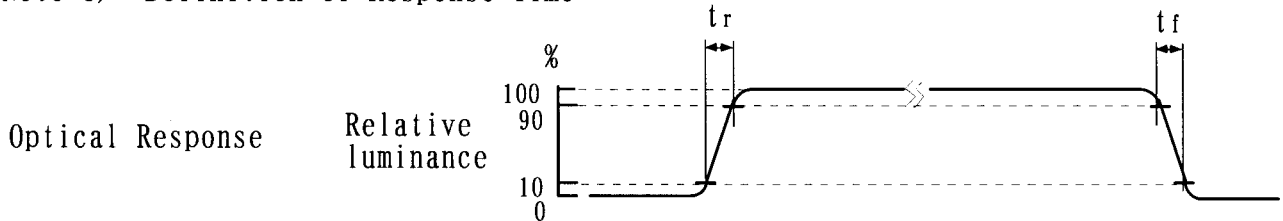

Note 4) Definition of Brightness Uniformity

The brightness uniformity (Buni) is defined as the following equation.

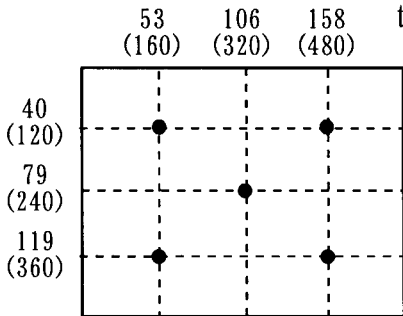

$$Buni = \frac{B_{min}}{B_{max}} \times 100$$

where, B_{max} = Maximum brightness among 5 measuring points
 B_{min} = Minimum brightness among 5 measuring points

• : measuring point

3. ELECTRICAL CHARACTERISTICS

(1) TFT LIQUID CRYSTAL DISPLAY MODULE

Ta=25°C, Vss=0V

ITEM	SYMBOL	MIN.	TYP.	MAX.	UNIT	NOTE
Power Supply Voltage	VDD	3.0	3.3	3.6	V	
Input Voltage for Logic Signal	Hi	V _{IH}	—	VDD	mV	1)
	Lo	V _{IL}	—	0.8		
Power Supply Current	I _{DD}	—	190	300	mA	2), 3)
Vsync Frequency	f _v	—	60	70	Hz	
Hsync Frequency	f _H	—	31.6	38	kHz	
DCLK Frequency	f _{CLK}	—	25	29	MHz	

Note 1) The specification is applicable to Display Data Signal pin, Timing Signal pin.
 2) f_v=60Hz, f_{CLK}=25MHz, VDD=3.3V, DC Current is measured with the method as below.

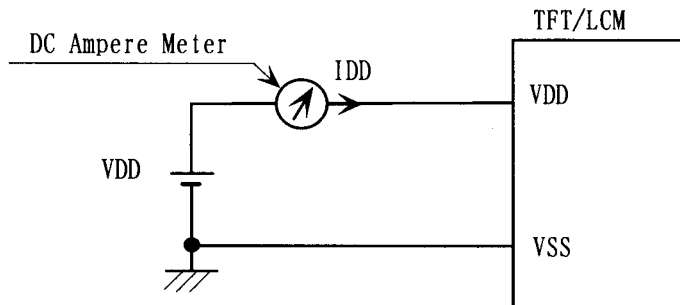

Typical value is measured when displaying Black Pattern.

Maximum is measured when displaying Vertical-stripe(Black-7 Gray scale)

- 3) 0.63A fuse is built in the unit. Current capacity for VDD power supply should be larger than 2A, so that the fuse built in the unit(Maximum) could appropriately work in the abnormal.

(2) BACK-LIGHT UNIT

Ta=25°C, GND=0V

ITEM	SYMBOL	MIN.	TYP.	MAX.	UNIT	NOTE
Lamp Current	I _L	4.0	6.0	6.5	mArms	1), 3)
Lamp Voltage	V _L	—	490	—	Vrms	
Frequency	f _L	50	—	70	kHz	2)
Starting Lamp Voltage	V _s	Ta=25°C	950	—	Vrms	
		Ta=-10°C	1200	—		

NOTE 1) Higher I_L cause the short life time of CFL.

2) Lamp operation frequency may produce interference with Hsync frequency, which causes rolling or flickering screen. Therefore lamp operation frequency shall be as different as possible from Hsync frequency, to avoid interference.

3) When I_L is measured, an ammeter is attached to the ground line.

4. BLOCK DIAGRAM

(1) TFT-LIQUID CRYSTAL DISPLAY MODULE

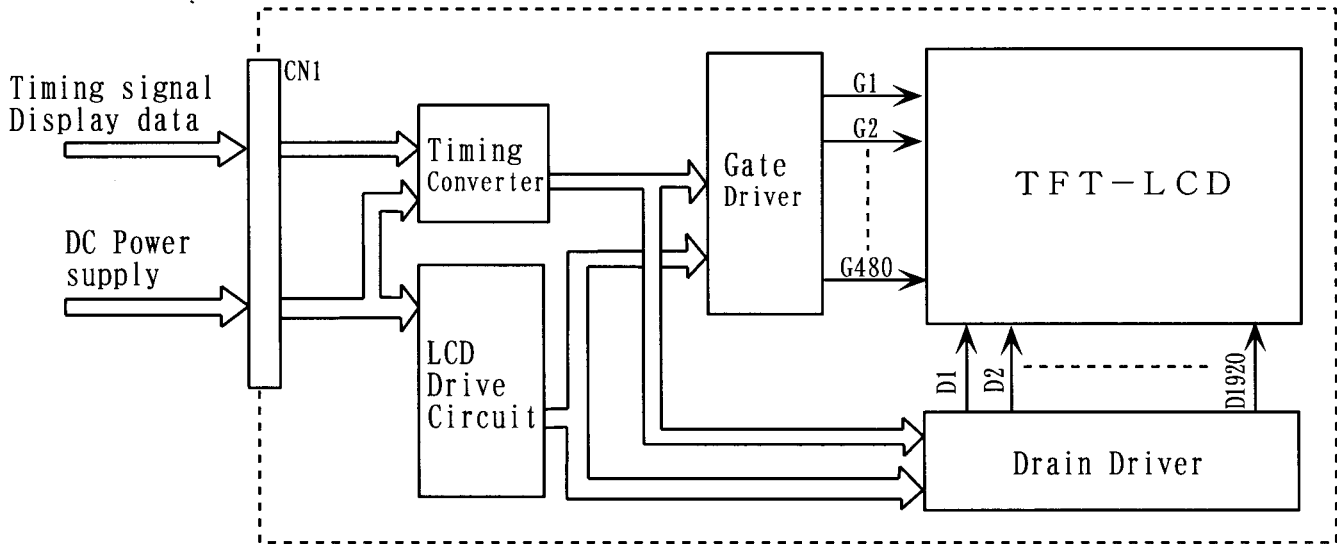

(2) BACK-LIGHT UNIT

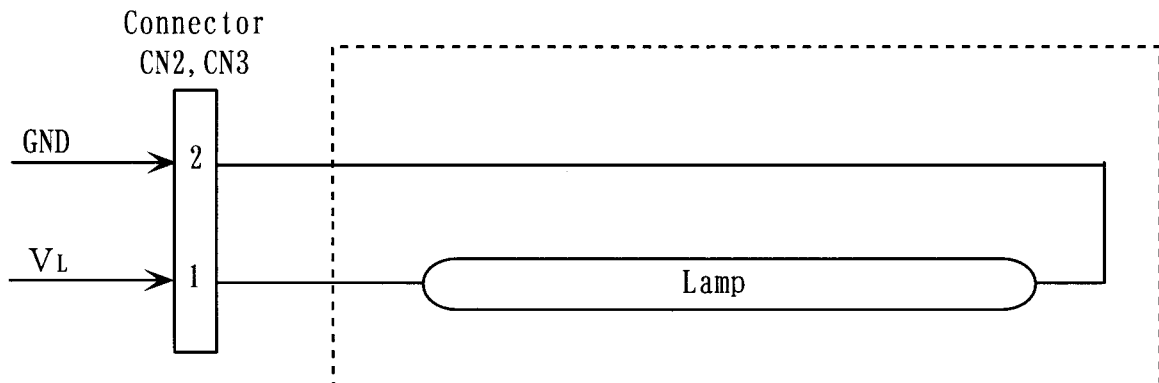

Color of wires CFL to CN2, CN3

1 (VL) : Pink
2 (GND) : Blue

5. INTERFACE PIN CONNECTION

(1) TFT-LIQUID CRYSTAL DISPLAY MODULE CN1 《HIROSE: FH12-32S-0.5SH(55)》

Pin No.	SYMBOL	FUNCTION	NOTE
1	VSS		2)
2	DCLK	Clock Signal	
3	NC		4)
4	NC		4)
5	VSS		2)
6	R0	Red Data Signal (LSB)	
7	R1	Red Data Signal	
8	R2	Red Data Signal	
9	R3	Red Data Signal	
10	R4	Red Data Signal	
11	R5	Red Data Signal (MSB)	
12	VSS		2)
13	G0	Green Data Signal (LSB)	
14	G1	Green Data Signal	
15	G2	Green Data Signal	
16	G3	Green Data Signal	
17	G4	Green Data Signal	
18	G5	Green Data Signal (MSB)	
19	VSS		2)
20	B0	Blue Data Signal (LSB)	
21	B1	Blue Data Signal	
22	B2	Blue Data Signal	
23	B3	Blue Data Signal	
24	B4	Blue Data Signal	
25	B5	Blue Data Signal (MSB)	
26	VSS		2)
27	DTMG	Display Timing Signal	
28	VDD	Power Supply 3.3V (typical)	1)
29	VDD	Power Supply 3.3V (typical)	1)
30	TEST	TEST Pin	3)
31	NC		4)
32	VSS		2)

- Notes 1) All VDD pins shall be connected to +3.3V(Typ.).
 2) All VSS pins shall be grounded. Metal bezel is internally connected to VSS.
 3) Keep open. Hitachi test use only.
 4) Unconnected to the module

(2) BACK-LIGHT UNIT CN2, CN3 《JST: BHR-02(8.0)VS-1N》

Pin No.	SYMBOL	FUNCTION	NOTE
1	VL	Power Supply	
2	GND	GND (0V)	

RELATIONSHIP BETWEEN DISPLAYED COLOR AND INPUT DATA

INPUT DATA COLOR		R DATA						G DATA						B DATA					
		R5	R4	R3	R2	R1	R0	G5	G4	G3	G2	G1	G0	B5	B4	B3	B2	B1	B0
		MSB			LSB			MSB			LSB			MSB			LSB		
BASIC COLOR	BLACK	0	0	0	0	0	0	0	0	0	0	0	0	0	0	0	0	0	0
	RED (0)	1	1	1	1	1	1	0	0	0	0	0	0	0	0	0	0	0	0
	GREEN (0)	0	0	0	0	0	0	1	1	1	1	1	1	0	0	0	0	0	0
	BLUE (0)	0	0	0	0	0	0	0	0	0	0	0	0	1	1	1	1	1	1
	CYAN	0	0	0	0	0	0	1	1	1	1	1	1	1	1	1	1	1	1
	MAGENTA	1	1	1	1	1	1	0	0	0	0	0	0	1	1	1	1	1	1
	YELLOW	1	1	1	1	1	1	1	1	1	1	1	1	0	0	0	0	0	0
	WHITE	1	1	1	1	1	1	1	1	1	1	1	1	1	1	1	1	1	1
RED	BLACK	0	0	0	0	0	0	0	0	0	0	0	0	0	0	0	0	0	0
	RED (62)	0	0	0	0	0	1	0	0	0	0	0	0	0	0	0	0	0	0
	RED (61)	0	0	0	0	1	0	0	0	0	0	0	0	0	0	0	0	0	0
	⋮	⋮	⋮	⋮	⋮	⋮	⋮	⋮	⋮	⋮	⋮	⋮	⋮	⋮	⋮	⋮	⋮	⋮	⋮
	RED (2)	1	1	1	1	0	1	0	0	0	0	0	0	0	0	0	0	0	0
	RED (1)	1	1	1	1	1	0	0	0	0	0	0	0	0	0	0	0	0	0
	RED (0)	1	1	1	1	1	1	0	0	0	0	0	0	0	0	0	0	0	0
GREEN	BLACK	0	0	0	0	0	0	0	0	0	0	0	0	0	0	0	0	0	0
	GREEN (62)	0	0	0	0	0	0	0	0	0	0	1	0	0	0	0	0	0	0
	GREEN (61)	0	0	0	0	0	0	0	0	0	0	1	0	0	0	0	0	0	0
	⋮	⋮	⋮	⋮	⋮	⋮	⋮	⋮	⋮	⋮	⋮	⋮	⋮	⋮	⋮	⋮	⋮	⋮	⋮
	GREEN (2)	0	0	0	0	0	0	1	1	1	1	0	1	0	0	0	0	0	0
	GREEN (1)	0	0	0	0	0	0	1	1	1	1	1	0	0	0	0	0	0	0
	GREEN (0)	0	0	0	0	0	0	1	1	1	1	1	1	0	0	0	0	0	0
BLUE	BLACK	0	0	0	0	0	0	0	0	0	0	0	0	0	0	0	0	0	0
	BLUE (62)	0	0	0	0	0	0	0	0	0	0	0	0	0	0	0	0	0	1
	BLUE (61)	0	0	0	0	0	0	0	0	0	0	0	0	0	0	0	0	1	0
	⋮	⋮	⋮	⋮	⋮	⋮	⋮	⋮	⋮	⋮	⋮	⋮	⋮	⋮	⋮	⋮	⋮	⋮	⋮
	BLUE (2)	0	0	0	0	0	0	0	0	0	0	0	0	1	1	1	1	0	1
	BLUE (1)	0	0	0	0	0	0	0	0	0	0	0	0	1	1	1	1	1	0
	BLUE (0)	0	0	0	0	0	0	0	0	0	0	0	0	1	1	1	1	1	1

- Note 1) Definition of gray scale :
 Color(n) --- number in parenthesis indicates gray scale level.
 Larger number corresponds to darker level.
- 2) Data : 1:High, 0:Low

6. INTERFACE TIMING

(1) TIMING CHART

Hsync, Vsync, DTMG, DATA
 G0~5 R0~5 B0~5

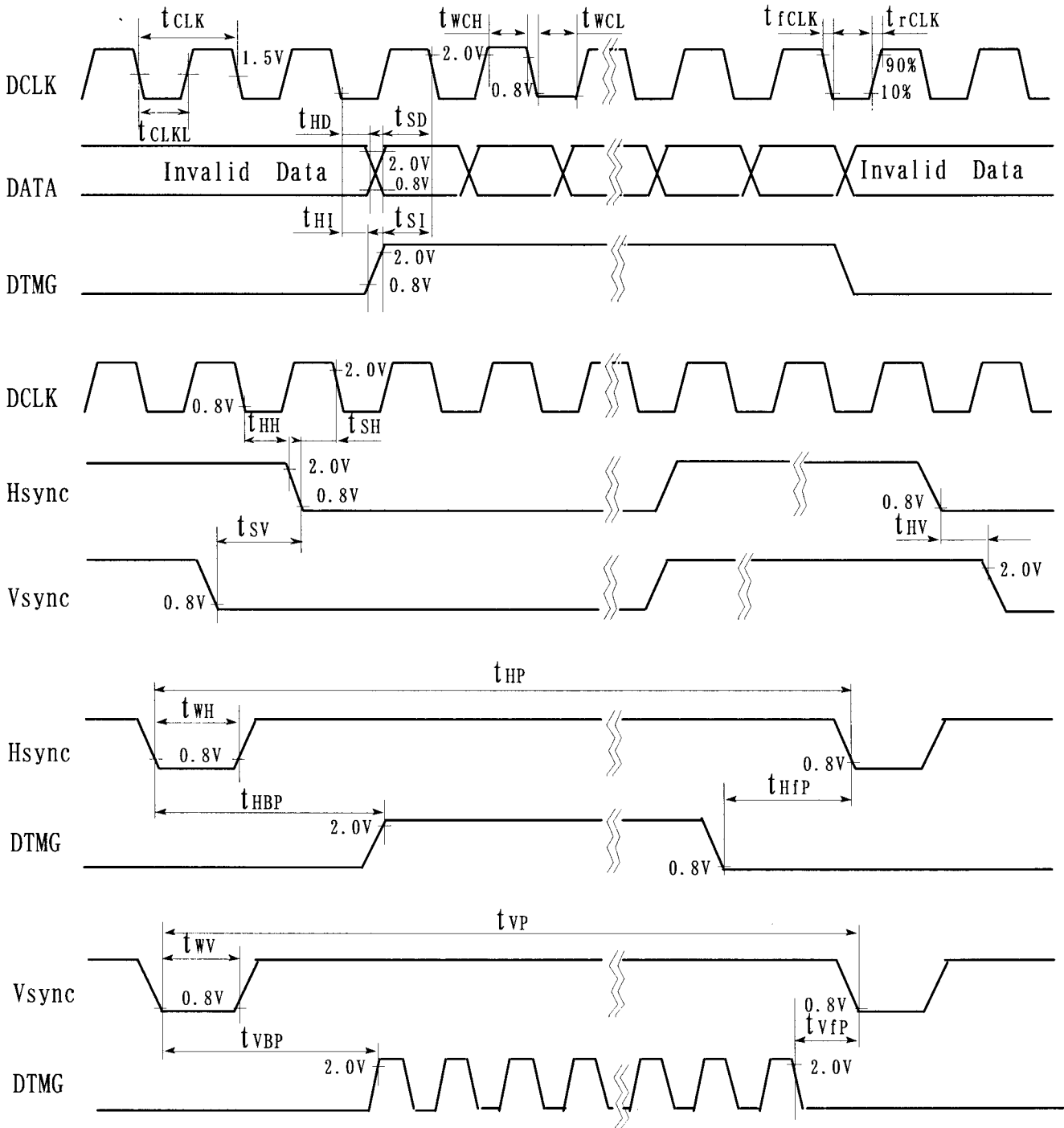
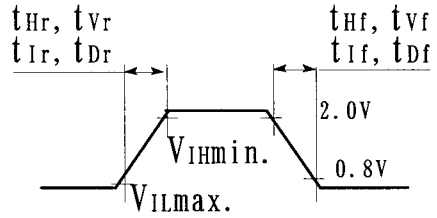

* The DTMG signal for this module is defined as above-mentioned timings for Vsync and Hsync. This module synchronizes with only DTMG and don't require inputting Vsync and Hsync signals. During Blanking period, DTMG should be "Low" level.

(2) INTERFACE TIMING SPECIFICATIONS

	Item	Symbol	Min.	Typ.	Max.	Unit	Note
DCLK	Period	t _{CLK}	34.5	40	43	ns	
	Width-Low	t _{wCL}	12	—	—		
	Width-Hi	t _{wCH}	12	—	—		
	Rise Time	t _{rCLK}	—	—	25		
	Fall Time	t _{fCLK}	—	—	25		
	Duty	D	0.45	0.5	0.55	—	D = t _{CLKL} / t _{CLK}
Hsync	Set up Time	t _{SH}	5	—	—	ns	for DCLK
	Hold Time	t _{HH}	10	—	—		
	Period	t _{HP}	760	800	870	t _{CLK}	
	Width-Active	t _{WH}	5	96	—		
	Rise/Fall Time	t _{Hr} , t _{Hf}	—	—	30	ns	
Vsync	Set up Time	t _{SV}	0	—	—	t _{CLK}	for Hsync
	Hold Time	t _{HV}	2	—	—		
	Period	t _{VP}	515	525	609	t _{HP}	
	Width-Active	t _{wV}	1	—	—		
	Rise/Fall Time	t _{vR} , t _{vF}	—	—	50	ns	
DTMG	Set up Time	t _{SI}	5	—	—	ns	for DCLK
	Hold Time	t _{HI}	10	—	—		
	Rise/Fall Time	t _{Ir} , t _{If}	—	—	30	ns	
	Horizontal Back porch	t _{HBP}	7	144	—		
	Horizontal Front porch	t _{HFP}	—	16	—	t _{CLK}	
	Vertical Back porch	t _{VBP}	4	35	—	t _{HP}	
	Vertical Front porch	t _{VFP}	—	10	—		
DATA	Set up Time	t _{SD}	5	—	—	ns	for DCLK
	Hold Time	t _{HD}	10	—	—		
	Rise/Fall Time	t _{Dr} , t _{Df}	—	—	25	ns	

(3) TIMING BETWEEN INTERFACE SIGNAL AND POWER SUPPLY

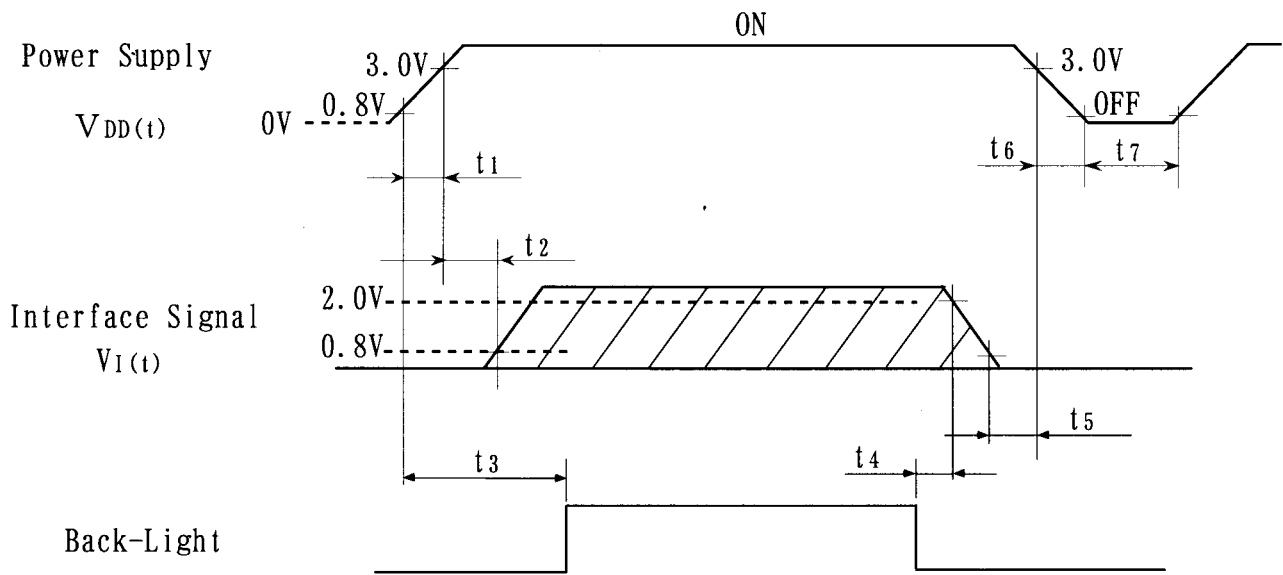

<u>POWER ON</u>		<u>POWER OFF</u>	
	$t_1 \leq 15\text{ms}$	$5\text{ms} \leq t_4$	
$0\text{ms} < t_2 \leq 45\text{ms}$		$0\text{ms} \leq t_5 \leq 45\text{ms}$	
$0.1\text{s} \leq t_3$		$0\text{ms} \leq t_6 \leq 20\text{ms}$	
		$0.4\text{s} \leq t_7$	

Note 1) Set $0\text{V} \leq V_I(t) \leq V_{DD}(t)$.
 Here, $V_I(t)$, $V_{DD}(t)$ indicate the transitive state of V_I , V_{DD} when power supply is turned ON or OFF.

Note 2) Do not keep interface signal high-impedance when power on.

7. DIMENSIONAL OUTLINE Front-Side

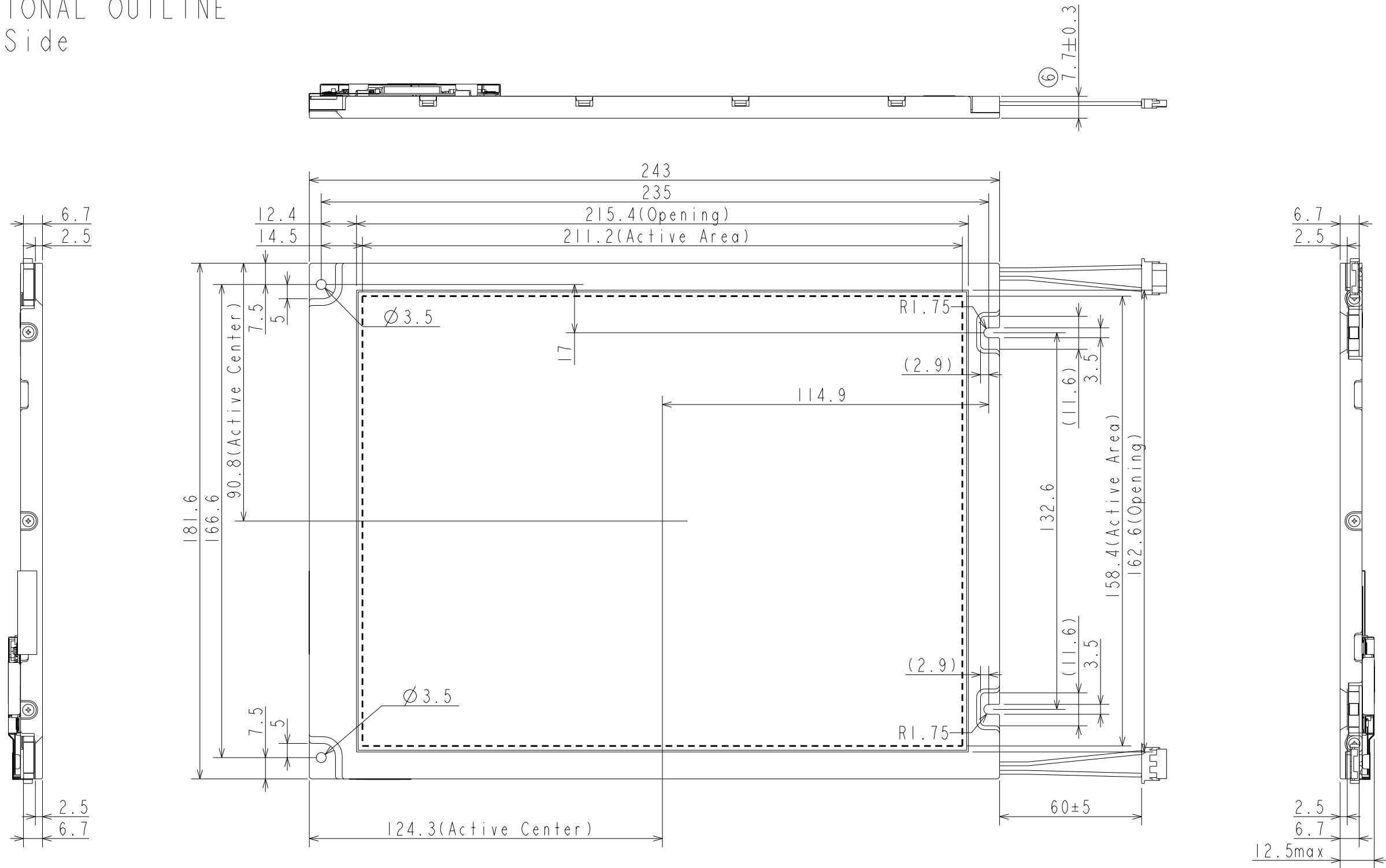

NOTE

- ① Interface connector
HRS:FH12-32S-0.5SH(55)
- ② CFL cable connector
JST:BHR-02(8.0)VS-1N
- ③ The unspecified tolerance:±0.5mm
- ④ Holes for mounting LCD MODULE
top mounting:4holes
- ⑤ The screws mounted in the side of LCD MODULE:6points
- ⑥ Dimension measurement should be done with adding pressure of 9.8×10^4 Pa

UNIT:mm

Hitachi Displays, Ltd.	Date	Oct. 20,2005	Sh. No.	3284PS 2610-TX26D02VM1CAA-2	Page	10-1/2
------------------------	------	--------------	---------	-----------------------------	------	--------

Back-Side

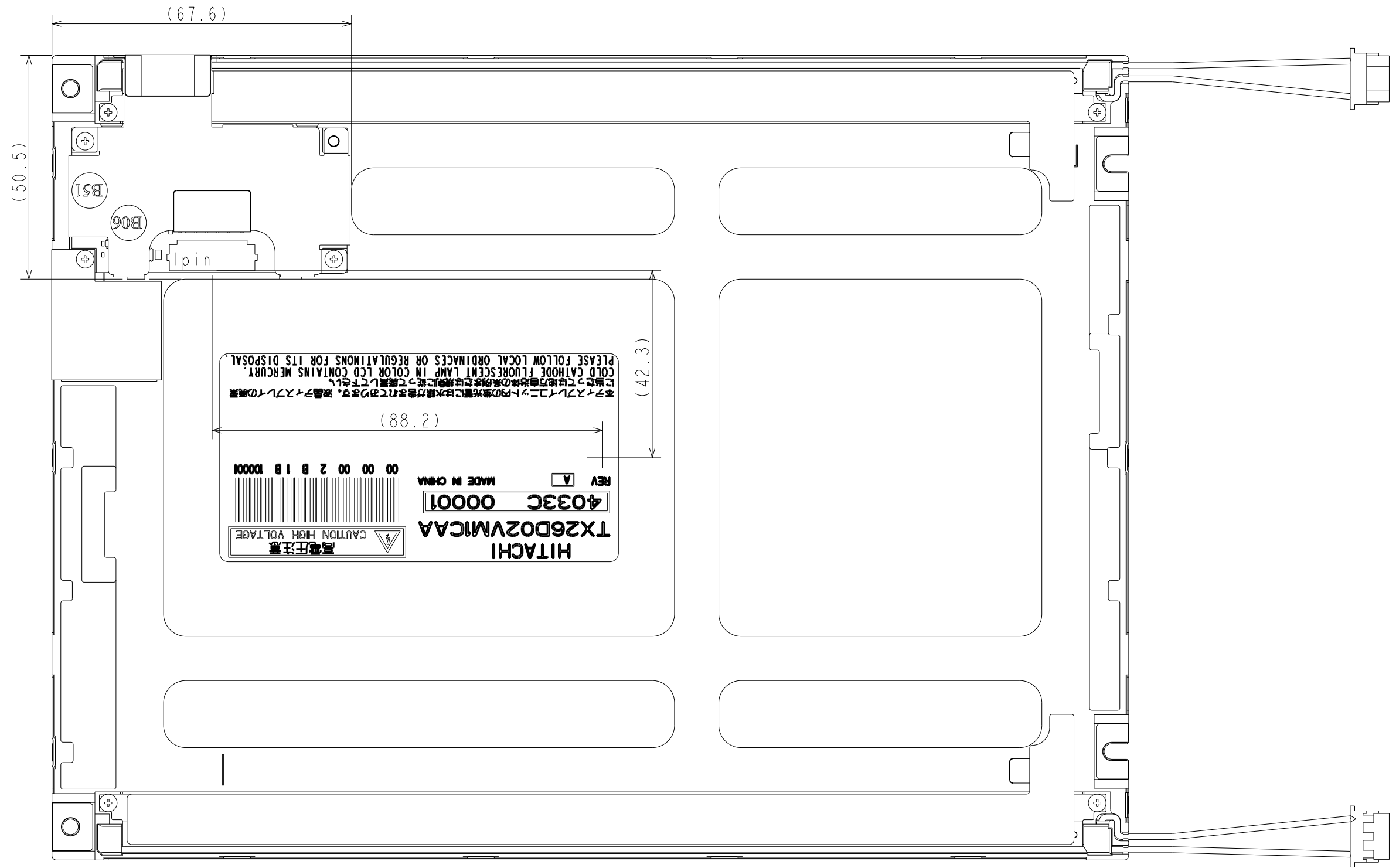

8. DESIGNATION OF LOT MARK

8.1 LOT MARK

Lot Mark is consisted of 4 digits for production lot and 7 digits for production control.

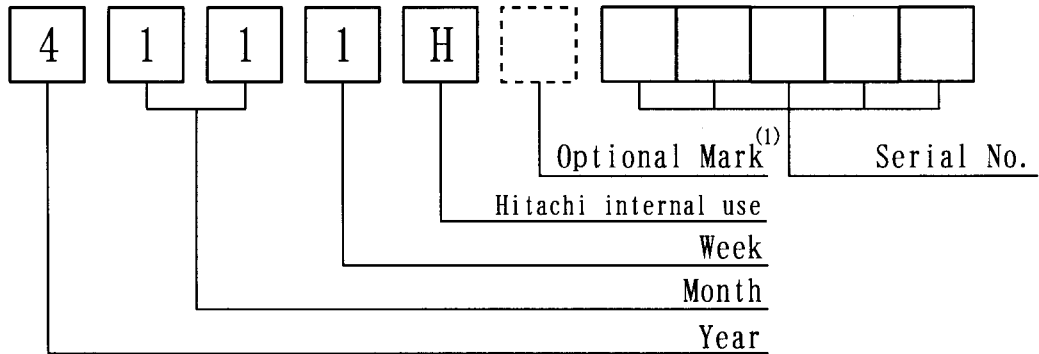

Year	Figure in Lot Mark
2004	4
2005	5
2006	6
2007	7
2008	8

Week(day in calender)	Figure in Lot Mark
1~7	1
8~14	2
15~21	3
22~28	4
29~31	5

Note 1) Optional Mark for Hitachi.

Month	Figure in Lot Mark	Month	Figure in Lot Mark
1	01	7	07
2	02	8	08
3	03	9	09
4	04	10	10
5	05	11	11
6	06	12	12

Hitachi internal use	
H	Made in Japan
C	Made in China
T	Made in Taiwan

8.2 Serial No.

Serial No. is consisted of 5 digits number (00001~99999).

8.3 LOCATION OF LOT MARK

Label is attached on the back side of module.

The items are subject to change without notice.

< Made in Japan >

Lot No. &
Production Control No.

Revision



< Made in China >

Lot No. &
Production Control No.

Revision



< Made in Taiwan >

Lot No. &
Production Control No.

Revision



9. COSMETIC SPECIFICATIONS

9.1 CONDITIONS FOR COSMETIC INSPECTION

(1) Viewing zone

- i) The figure shows the correspondence between eyes (of inspector) and TFT/LCD module.
 - $\theta \leq 15^\circ$ when non-operating inspection
 - $\theta \leq 5^\circ$ when operating inspection
- ii) Inspection should be executed only from front side, and only A-zone. Cosmetic of B-zone and C-zone are ignored.
(refer to 9.2 DEFINITION OF ZONE)

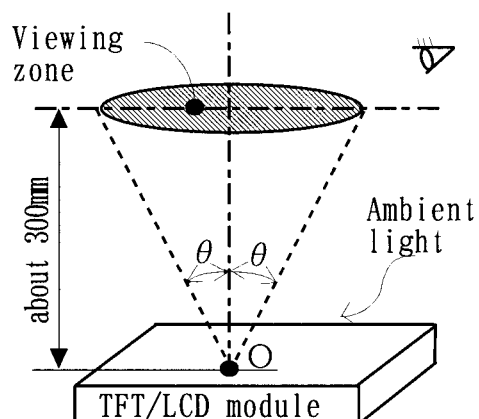

(2) Environmental

- i) Temperature : 25°C
When operating inspection, surface temperature of LCD panel is 25°C.
- ii) Ambient light : More than 2000 [lx] and non-directive.
- iii) Back-light : When non-operating inspection, Back-light should be off.

(3) Operating inspection

Operating inspection should be done with 8 color mode (without gray scale).

9.2 DEFINITION OF ZONE

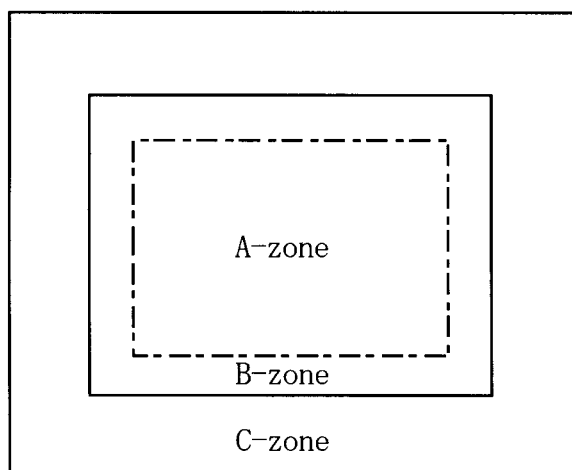

- A-zone : Display area (pixel area).
- B-zone : Area between A-zone and C-zone.
- C-zone : Metal bezel area.
(Include I/F connector)

9.3 COSMETIC SPECIFICATIONS

When displaying condition is not stable (ex. at turn on or off), the following specifications are not applied.

No.	ITEM		MAXMUM ACCEPTABLE NUMBER		UNIT	NOTE
			A-zone			
1	Dot Defect	Sparkle mode	1dot	5	pcs	1), 2), 4)
			2dots	2	units	1), 2), 5)
			3dots	0		
			4dots	0		
			Minimum distance between defect dots $\leq 15\text{mm}$	2	pcs/ $\phi 15$	1), 2), 6)
			Total	5	pcs	1), 2)
		Black mode	1dot	10	pcs	1), 3), 4)
			2dots	5	units	1), 3), 5)
			3dots	0		
			4dots	0		
			Minimum distance between defect dots $\leq 15\text{mm}$	3	$\text{ヶ}/\phi 5$	1), 3), 7)
			Total	10	pcs	1), 3)
		Total		15	pcs	1)
2	Line Defect		Serious one is no good.		-	-
3	Uneven Brightness					
4	Stain Inclusion Line shape W:width[mm] L:length[mm]	$W \leq 0.06$	L : Ignore	Ignore	pcs	8)
		$W > 0.06$	$L > 0.1$	By Dot shape		
			$L \leq 0.1$	Ignore		
5	Stain Inclusion Dot shape D:average dia. [mm]	$D \leq 0.45$		Ignore	pcs	8)
		$D \leq 0.7$		5		
		$D > 0.7$		0		
6	Scratch on Polarizer Line shape W:width[mm] L:length[mm]	$W \leq 0.01$	L : Ignore	Ignore	pcs	9)
		$W \leq 0.02$	$L \leq 40$	10		
			$L > 40$	0		
		$W \leq 0.04$	$L \leq 20$	10		
$L > 20$	0					
7	Scratch on Polarizer Dot shape D:average dia. [mm]	$D \leq 0.45$		Ignore	pcs	9)
		$D \leq 0.7$		10		
		$D > 0.7$		0		

No.	ITEM		MAXMUM ACCEPTABLE NUMBER	UNIT	NOTE
			A-zone		
8	Bubble of Polarizer D:average dia. [mm]	$D \leq 0.3$	Ignore	pcs	9)
		$D \leq 0.5$	10		
		$D \leq 1.0$	5		
		$D > 1.0$	0		
9	Wrinkles of Polarizer		Serious one is no good.	—	
10	Burr of Polarizer edge	$L \leq 1.0$	Ignore	pcs	
		$L > 1.0$	0		

- Note
- 1) Dot Defect : Defect area $> 1/2$ dot
 - 2) Sparkle mode : Brightness of dot is more than 30% at Black raster. (Visible to eye)
 - 3) Black mode : Brightness of dot is less than 70% at white raster. (Visible to eye)
 - 4) 1 dot : defect dot is isolated, not attached to other defect dot.
 - 5) N dots : N defect dots are consecutive. (N means the number of defect dots. $(N \geq 2)$)
 - 6) Dense Dot Defect of Sparke mode : the number of defects in the area of $\phi 15\text{mm}$.
 - 7) Dense Dot Defect of Black mode : the number of defects in the area of $\phi 15\text{mm}$.
 - 8) Those stains which can be wiped out easily are acceptable.
 - 9) Polaraizer area inside of A-zone is applied, and B/C-zone is not applied.

10. PRECAUTIONS

Please pay attention to the followings when you use this TFT/LCD module with Back-light unit.

10.1 MOUNTING PRECAUTION

- (1) You must mount Module using mounting holes arranged in 8 corners tightly.
- (2) You should consider the mounting structure so that uneven force (ex. twisted stress) is not applied to Module.
And the case which Module is mounted should have sufficient strength so that external force is not transmitted directly to Module.
- (3) To improve the strength of module against the mechanical shock the space between module and the case should be 0.3~1.0mm.

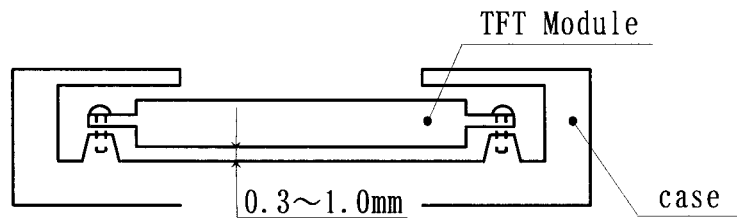

- (4) You should adopt radiation structure to satisfy the temperature specification.
- (5) Acetic acid type and choline type materials for the cover case are not desirable because the former generate corrosive gas of attacking the polarizer at high temperature and the latter causes circuit break by electro-chemical reaction.
- (6) Do not touch, push or rub the exposed polarizers with glass, tweezers or anything harder than HB pencil lead. And please do not rub by dustclothes with chemical treatment.
Do not touch the surface of polarizer with bare hand or greasy close.
(Some cosmetics are detrimental to the polarizer.)
- (7) When the surface becomes dusty, please wipe gently with absorbent cotton or other soft materials chamois soaked petroleum benzin.
IPA(Iso-Propyl Alcohol) is recommended for cleaning the adhesives used to attach front /rear polarizers. Do not use acetone, toluen and alcohol because they cause chemical damage to the polarizer.
- (8) Wipe off saliva or water drops as soon as possible. Their long time contact with polarizer causes deformations and color fading.
- (9) Do not open the case because inside circuits have not sufficient strength.
- (10) Use fingerstalls of soft gloves in order to keep clean display quality, when you handle the device for incoming inspection and assembly.
- (11) Do not pull or do not fold the CFL cable.

10.2 OPERATING PRECAUTION

- (1) Response time depends on the temperature. (In lower temperature, it becomes longer).
And also Transmittance and Color depend on the temperature.
- (2) Brightness depends on the temperature. (In lower temperature, it becomes lower).
And in lower temperature, response time (required time that brightness is stable after turn on) becomes longer.
- (3) Optical characteristics (eg. luminance, uniformity, color coordinate etc.) gradually change by operating condition, especially low temperature change faster, because LCD module has Cold Cathode Fluorescent Lamp.
- (4) Be careful for condensation at sudden temperature change.
Condensation make damage to polarizer or electrical contact part.
And after fading condensation, smear or spot will occur.
- (5) When fixed patterns are displayed at long times, afterimage is likely to occur.
- (6) The Module have high frequency circuit. If you need to shield the electromagnetic noise, please do in yours.
- (7) When Back-light unit is operating, it sounds.
If you need to shield the noise, please do in yours.
- (8) Please connect the Back-light connector to the inverter circuit directly.
The long cable between CFL and the inverter may cause the brightness drop of CFL and may cause the rise of starting lamp Voltage(Vs).
In addition, it causes CFL life to shorten.
- (9) Do not connect or remove the module from main system with power applied.

10.3 ELECTROSTATIC DISCHARGE CONTROL

- (1) Since Module is composed with electronic circuit, it is not strong to electrostatic discharge. Make certain that treatment persons are connected to ground through list band etc.. And don't touch I/F pin directly.
- (2) When the polaraizer protection film is peeled off, electrostatic discharge occurs. Please peel it off slowly.

10.4 PRECAUTION FOR STRONG LIGHT EXPOSURE

Strong light exposure causes degradation of polarizer and color filter.

Hitachi Displays, Ltd.	Date	Oct. 20, 2005	Sh. No.	3284PS 2613-TX26D02VM1CAA-2	Page	13-2/4
------------------------	------	---------------	---------	-----------------------------	------	--------

10.5 STORAGE

When storing Module as spares for long time, the following precautions are necessary.

- (1) Store them in a dark place ; do not expose them to sunlight or fluorescent light.
Keep the temperature between 5°C and 35°C at normal humidity.
- (2) The polarizer surface should not come in contact with any other object. It is recommended that they be stored in the container in which they were shipped.

10.6 HANDLING PRECAUTIONS FOR PROTECTIVE FILM

- (1) When the protective film is peeled off, static electricity is generated between the film and the polarizer.
This film should be peeled off slowly and carefully by people who are electrically grounded and with well ion-blown equipment or in such a condition, etc.
- (2) The protective film is attached to the polarizer with a small amount of glue. If some stress is applied to rub the protective film against the polarizer during the time you peel off the film, the glue is apt to remain more on the polarizer. So please carefully peel off the protective film without rubbing it against the polarizer.
- (3) When the Module with protective film attached is stored for long time, sometimes there remains a very small amount of glue, still on the polarizer after the protective film is peeled off.
Please refrain from storing the Module at the high temperature and high humidity for glue is apt to remain in these condition.
- (4) The Glue may be taken for the Modules failure, but you can remove the Glue easily.
When the glue remains on the polarizer surface or its vestige is recognized, please wipe them off with absorbent cotton waste or other soft material like chamois soaked with IPA(Iso-Propyl Alcohol).

10.7 SAFETY

- (1) If Module is broken, be careful to handle not to injure. (TFT/LCD and Lamp are made of glass.)
Please wash hands sufficiently when you touch the liquid crystal coming out from broken LCDs.
- (2) As Back-light unit has high voltage circuit internal, do not open the case and do not insert foreign materials in the case.
- (3) The LCD Modules include Cold Cathode Fluorescent Lamp(CFL).
CFL contains a small amount of mercury. Please follow local ordinances or regulations for disposal.