







SMT POWER INDUCTORS

Flat Coils - PG0426NL Series



-  **Height:** 3.2mm Max
-  **Footprint:** 7.5mm x 7.0mm Max
-  **Current Rating:** 60Apk
-  **RoHS compliant**
-  **Low DC Resistance**
-  **High temperature core material, no thermal aging below 150°C**

Electrical Specifications @ 25°C — Operating Temperature -40°C to +130°C¹

Part ⁶ Number	Inductance @0Adc ($\mu\text{H} \pm 20\%$)	DCR (m Ω)		Saturation ² Current Isat (A)	Heating ³ Current Ibc (A)	Core Loss ⁴ Factor K2
		TYP	MAX			
PG0426.101NL	0.10	1.3	1.5	60	34.5	44.4
PG0426.151NL	0.15	2.0	2.2	57	26.0	40.0
PG0426.201NL	0.20	2.0	2.2	46	26.0	53.3
PG0426.221NL	0.22	2.0	2.2	40	26.0	58.6
PG0426.331NL	0.33	3.2	3.4	34	20.0	62.8
PG0426.471NL	0.47	3.2	3.4	26	20.0	89.4
PG0426.681NL	0.68	5.2	5.4	25	15.5	100.6
PG0426.821NL	0.82	7.8	8.0	24	13.0	99.3
PG0426.102NL	1.00	7.8	8.0	22	13.0	121.1
PG0426.152NL	1.50	11.5	11.8	18	9.0	153.6

Mechanical

Schematic

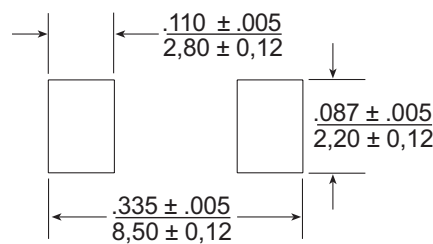
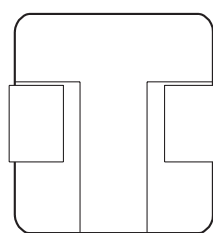
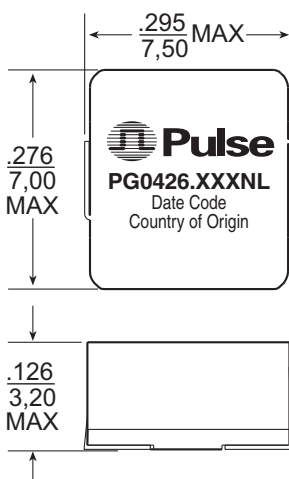

SUGGESTED PAD LAYOUT

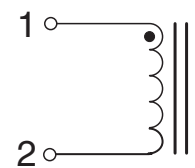

Weight.....0.6 grams
 Tape & Reel1400/reel
 Dimensions: Inches
 mm
 Unless otherwise specified,
 all tolerances are $\pm .010$
 0,25

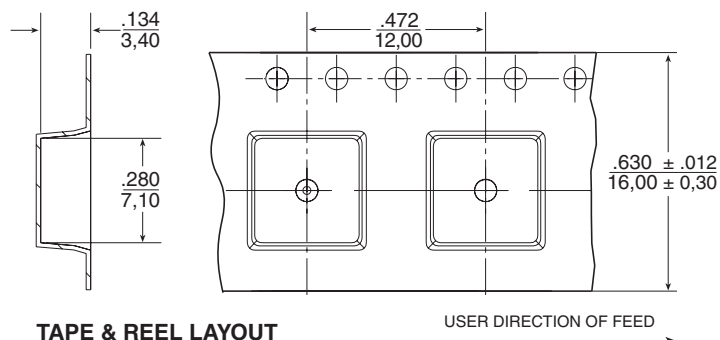

TAPE & REEL LAYOUT

USER DIRECTION OF FEED

SMT POWER INDUCTORS

Flat Coils - PG0426NL Series



Notes from Tables

1. The temperature of the component (ambient plus temperature rise) must be within the standard operating temperature range.
2. The saturation current, I_{SAT} , is the current at which the component inductance drops by 30% (typical) at an ambient temperature of 25°C. This current is determined by placing the component in the specified ambient environment and applying a short duration pulse current (to eliminate self-heating effects) to the component.
3. The heating current, I_{DC} , is the DC current required to raise the component temperature by approximately 40°C. The heating current is determined by mounting the component on a typical PCB and applying current for 30 minutes. The temperature is measured by placing the thermocouple on top of the unit under test. Take note that the component's performance varies depending on the system condition. It is suggested that the component be tested at the system level, to verify the temperature rise of the component during system operation.
4. Core loss approximation is based on published core data:

$$\text{Core Loss} = K1 * (f)^{1.33} * (K2\Delta I)^{2.51}$$

Where: Core Loss = in Watts
 $K1 = 8.75E-9$
 f = switching frequency in kHz
 $K1$ & $K2$ = core loss factors
 ΔI = delta I across the component in Ampere
 $K2\Delta I$ = one half of the peak to peak flux density across the component in Gauss
5. Unless otherwise specified, all testing is made at 100kHz, 0.1V_{AC}.
6. Optional Tape & Reel packaging can be ordered by adding a "T" suffix to the part number (i.e. PG0426.101NL becomes PG0426.101NLT). Pulse complies to industry standard tape and reel specification EIA481.

Inductance vs Current Characteristics

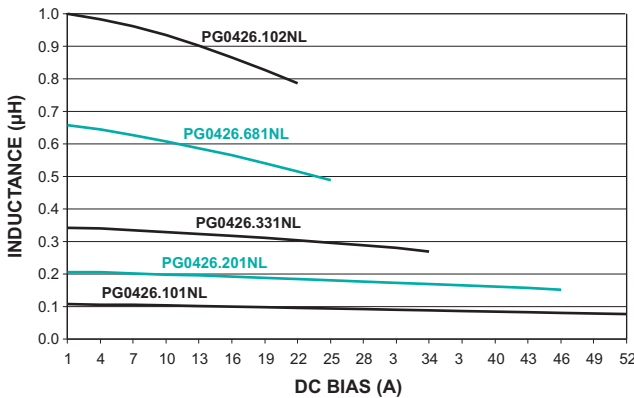

Typical Core Loss vs Peak Flux Density

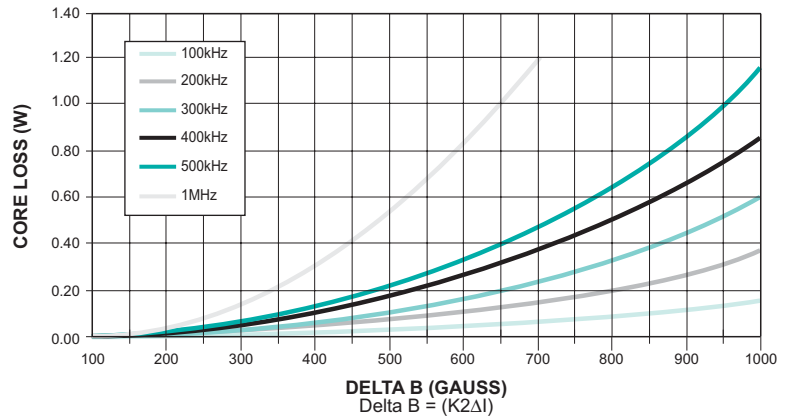

For More Information:

Pulse Worldwide Headquarters

12220 World Trade Dr.
San Diego, CA 92128
U.S.A.

www.pulseeng.com

TEL: 858 674 8100

FAX: 858 674 8262

Pulse Europe

Einsteinstrasse 1
D-71083 Herrenberg
Germany

Tel: 49 7032 7806 116

Fax: 49 7032 7806 135

Pulse China Headquarters

No. 1
Industrial District
Changan, Dongguan
China

Tel: 86 769 85538070

Fax: 86 769 85538870

Pulse North China

Room 1503
XinYin Building
No. 888 YiShan Rd.
Shanghai 200233
China

Tel: 86 21 54643211/2

Fax: 86 21 54643210

Pulse South Asia

150 Kampong Ampat
#07-01/02
KA Centre
Singapore 368324

Tel: 65 6287 8998

Fax: 65 6280 0080

Pulse North Asia

No. 26
Kao Ching Rd.
Yang Mei Chen
Taoyuan Hsien
Taiwan, R. O. C.

Tel: 886 3 4641811

Fax: 886 3 4641911

Performance warranty of products offered on this data sheet is limited to the parameters specified. Data is subject to change without notice. Other brand and product names mentioned herein may be trademarks or registered trademarks of their respective owners.

© Copyright, 2006. Pulse Engineering, Inc. All rights reserved.

www.pulseeng.com

P649.A (6/06)