

Timing Generator for Frame Readout CCD Image Sensor

Description

The CXD3606R is a timing generator IC which generates the timing pulses for performing frame readout using the ICX412 CCD image sensor.

Features

- Base oscillation frequency 45MHz
- Electronic shutter function
- Supports draft (sextuple speed) / AF (auto focus) drive
- Horizontal driver for CCD image sensor
- Vertical driver for CCD image sensor

Applications

Digital still cameras

Structure

Silicon gate CMOS IC

Applicable CCD Image Sensors

ICX412 (Type 1/1.8, 3240K pixels)

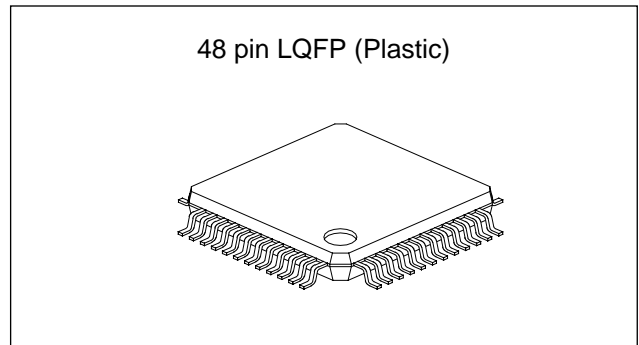

Absolute Maximum Ratings

• Supply voltage	V_{DD}	$V_{SS} - 0.3$ to $+7.0$	V
	V_L	-10.0 to V_{SS}	V
	V_H	$V_L - 0.3$ to $+26.0$	V
• Input voltage	V_I	$V_{SS} - 0.3$ to $V_{DD} + 0.3$	V
	• Output voltage	V_{O1}	$V_{SS} - 0.3$ to $V_{DD} + 0.3$
V_{O2}		$V_L - 0.3$ to $V_{SS} + 0.3$	V
V_{O3}		$V_L - 0.3$ to $V_H + 0.3$	V
• Operating temperature	T_{opr}	-20 to $+75$	°C
	• Storage temperature	T_{stg}	-55 to $+150$

Pin Configuration

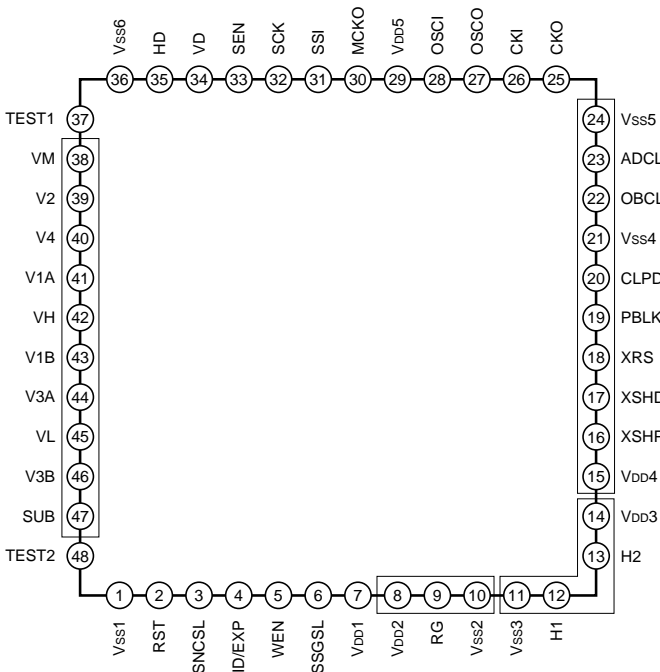

Recommended Operating Conditions

• Supply voltage	V_{DDB}	3.0 to 5.25	V
	$V_{DDA}, V_{DDC}, V_{DDD}$	3.0 to 3.6	V
	V_M	0.0	V
• Operating temperature	V_H	14.5 to 15.5	V
	V_L	-7.0 to -8.0	V
	T_{opr}	-20 to $+75$	°C

* Groups of pins enclosed in the figure indicate sections for which power supply separation is possible.

Sony reserves the right to change products and specifications without prior notice. This information does not convey any license by any implication or otherwise under any patents or other right. Application circuits shown, if any, are typical examples illustrating the operation of the devices. Sony cannot assume responsibility for any problems arising out of the use of these circuits.

Block Diagram

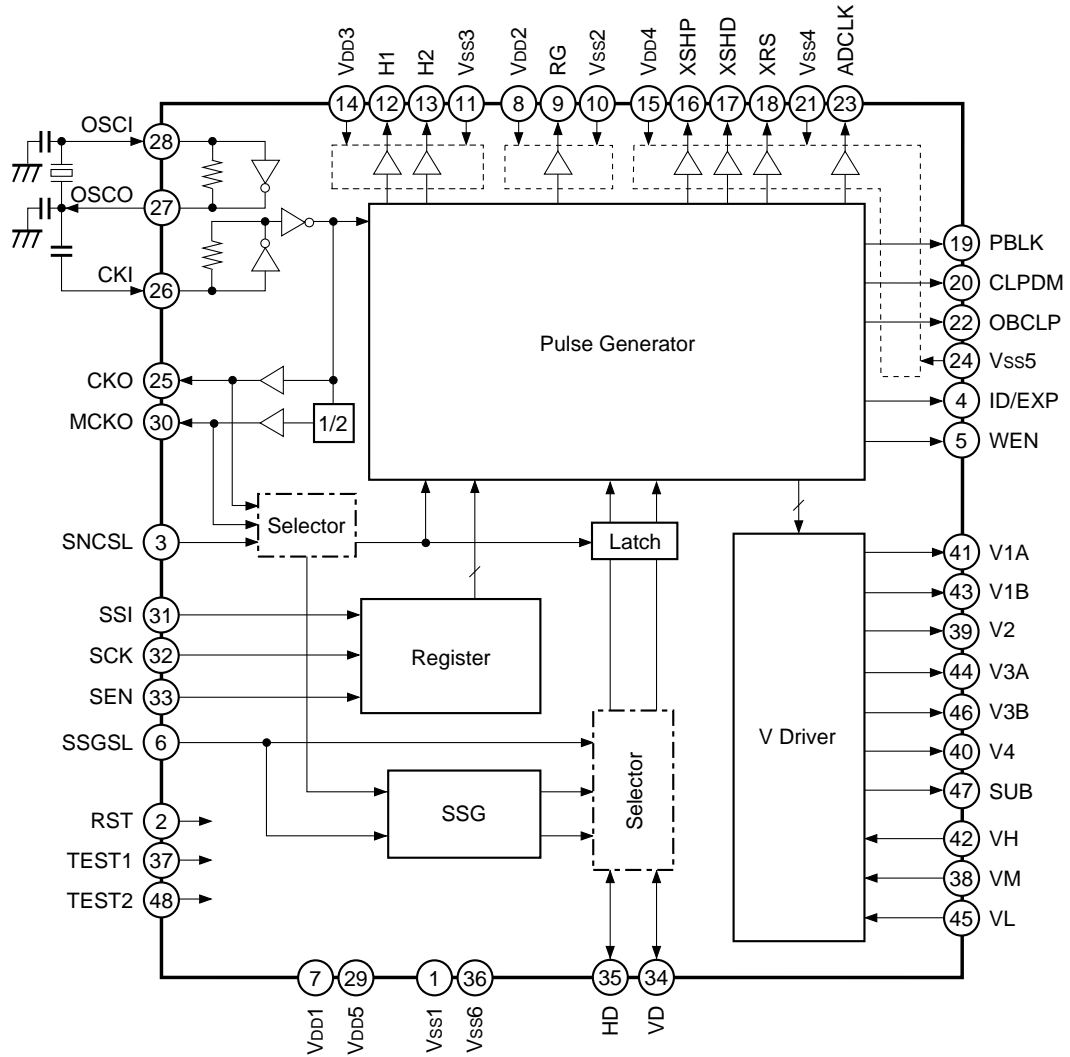

Pin Description

Pin No.	Symbol	I/O	Description
1	Vss1	—	GND
2	RST	I	Internal system reset input. High: Normal operation, Low: Reset control Normally apply reset during power-on. Schmitt trigger input/protective diode on power supply side
3	SNCSL	I	Control input used to switch sync system. High: CKI sync, Low: MCKO sync With pull-down resistor
4	ID/EXP	O	Vertical direction line identification pulse output/exposure time identification pulse output. Switching possible using the serial interface data. (Default: ID)
5	WEN	O	Memory write timing pulse output
6	SSGSL	I	Internal SSG enable. High: Internal SSG valid, Low: External sync valid. With pull-down resistor
7	Vdd1	—	3.3V power supply. (Power supply for common logic block)
8	Vdd2	—	3.3V power supply. (Power supply for RG)
9	RG	O	CCD reset gate pulse output
10	Vss2	—	GND
11	Vss3	—	GND
12	H1	O	CCD horizontal register clock output
13	H2	O	CCD horizontal register clock output
14	Vdd3	—	3.3 to 5.0V power supply. (Power supply for H1/H2)
15	Vdd4	—	3.3V power supply. (Power supply for CDS)
16	XSHP	O	CCD precharge level sample-and-hold pulse output
17	XSHD	O	CCD data level sample-and-hold pulse output
18	XRS	O	Sample-and-hold pulse output for analog/digital conversion phase alignment
19	PBLK	O	Pulse output for horizontal and vertical blanking period pulse cleaning
20	CLPDM	O	CCD dummy signal clamp pulse output
21	Vss4	—	GND
22	OBCLP	O	CCD optical black signal clamp pulse output The horizontal/vertical OB pattern can be changed using the serial interface data.
23	ADCLK	O	Clock output for analog/digital conversion IC Logical phase adjustment possible using the serial interface data
24	Vss5	—	GND
25	CKO	O	Inverter output
26	CKI	I	Inverter input
27	OSCO	O	Inverter output for oscillation. When not used, leave open or connect a capacitor.
28	OSCI	I	Inverter input for oscillation. When not used, fix low.
29	Vdd5	—	3.3V power supply. (Power supply for common logic block)

Pin No.	Symbol	I/O	Description
30	MCKO	O	System clock output for signal processing IC
31	SSI	I	Serial interface data input for internal mode settings. Schmitt trigger input/protective diode on power supply side
32	SCK	I	Serial interface clock input for internal mode settings. Schmitt trigger input/protective diode on power supply side
33	SEN	I	Serial interface strobe input for internal mode settings. Schmitt trigger input/protective diode on power supply side
34	VD	I/O	Vertical sync signal input/output
35	HD	I/O	Horizontal sync signal input/output
36	Vss6	—	GND
37	TEST1	I	IC test pin 1; normally fixed to GND. With pull-down resistor
38	VM	—	GND (GND for vertical driver)
39	V2	O	CCD vertical register clock output
40	V4	O	CCD vertical register clock output
41	V1A	O	CCD vertical register clock output
42	VH	—	15.0V power supply. (Power supply for vertical driver)
43	V1B	O	CCD vertical register clock output
44	V3A	O	CCD vertical register clock output
45	VL	—	-7.5V power supply. (Power supply for vertical driver)
46	V3B	O	CCD vertical register clock output
47	SUB	O	CCD electronic shutter pulse output
48	TEST2	I	IC test pin 2; normally fixed GND. With pull-down resistor

Electrical Characteristics

DC Characteristics

(Within the recommended operating conditions)

Item	Pins	Symbol	Conditions	Min.	Typ.	Max.	Unit
Supply voltage 1	VDD2	VDDa		3.0	3.3	3.6	V
Supply voltage 2	VDD3	VDDb		3.0	3.3	5.25	V
Supply voltage 3	VDD4	VDDc		3.0	3.3	3.6	V
Supply voltage 4	VDD1, VDD5	VDDd		3.0	3.3	3.6	V
Input voltage 1*1	RST, SSI, SCK, SEN	V _{t+}		0.8V _{DDd}			V
		V _{t-}				0.2V _{DDd}	V
Input voltage 2*2	TEST1, TEST2, SNCSL, SSGSL	V _{IH1}		0.7V _{DDd}			V
		V _{IL1}				0.2V _{DDd}	V
Input/output voltage	VD, HD	V _{IH2}		0.8V _{DDd}			V
		V _{IL2}				0.2V _{DDd}	V
		V _{OH1}	Feed current where I _{OH} = -1.2 mA	V _{DDd} - 0.8			V
		V _{OL1}	Pull-in current where I _{OL} = 2.4mA			0.4	V
Output voltage 1	H1, H2	V _{OH2}	Feed current where I _{OH} = -22.0mA	V _{DDb} - 0.8			V
		V _{OL2}	Pull-in current where I _{OL} = 14.4mA			0.4	V
Output voltage 2	RG	V _{OH3}	Feed current where I _{OH} = -3.3mA	V _{DDa} - 0.8			V
		V _{OL3}	Pull-in current where I _{OL} = 2.4mA			0.4	V
Output voltage 3	XSHP, XSHD, XRS, PBLK, OBCLP, CLPDM, ADCLK	V _{OH4}	Feed current where I _{OH} = -3.3mA	V _{DDc} - 0.8			V
		V _{OL4}	Pull-in current where I _{OL} = 2.4mA			0.4	V
Output voltage 4	CKO	V _{OH5}	Feed current where I _{OH} = -6.9mA	V _{DDd} - 0.8			V
		V _{OL5}	Pull-in current where I _{OL} = 4.8mA			0.4	V
Output voltage 5	MCKO	V _{OH6}	Feed current where I _{OH} = -3.3mA	V _{DDd} - 0.8			V
		V _{OL6}	Pull-in current where I _{OL} = 2.4mA			0.4	V
Output voltage 6	ID/EXP, WEN	V _{OH7}	Feed current where I _{OH} = -2.4mA	V _{DDd} - 0.8			V
		V _{OL7}	Pull-in current where I _{OL} = 4.8mA			0.4	V
Output current 1	V1A, V1B, V3A, V3B, V2, V4	I _{OL}	V1A/B, V2, V3A/B, V4 = -8.25V	10.0			mA
		I _{OM1}	V1A/B, V2, V3A/B, V4 = -0.25V			-5.0	mA
		I _{OM2}	V1A/B, V3A/B = 0.25V	5.0			mA
		I _{OH}	V1A/B, V3A/B = 14.75V			-7.2	mA
Output current 2	SUB	I _{OSL}	SUB = -8.25V	5.4			mA
		I _{OSH}	SUB = 14.75V			-4.0	mA

*1 These input pins are Schmitt trigger inputs, and have a protective diode on the power supply side in the IC. Therefore, they do not support 5V input.

*2 This input pin is with pull-down resistor in the IC.

Note) The above table indicates the condition for 3.3V drive.

Inverter I/O Characteristics for Oscillation

(Within the recommended operating conditions)

Item	Pins	Symbol	Conditions	Min.	Typ.	Max.	Unit
Logical V _{th}	OSCI	LV _{th}			V _{DDd} /2		V
Input voltage	OSCI	V _{IH}		0.7V _{DDd}			V
		V _{IL}				0.3V _{DDd}	V
Output voltage	OSCO	V _{OH}	Feed current where I _{OH} = -3.6mA	V _{DDd} - 0.8			V
		V _{OL}	Pull-in current where I _{OL} = 2.4mA			0.4	V
Feedback resistor	OSCI, OSCO	RFB	V _{IN} = V _{DDd} or V _{SS}	500k	2M	5M	Ω
Oscillation frequency	OSCI, OSCO	f		20		50	MHz

Inverter Input Characteristics for Base Oscillation Clock Duty Adjustment

(Within the recommended operating conditions)

Item	Pins	Symbol	Conditions	Min.	Typ.	Max.	Unit
Logical V _{th}	CKI	LV _{th}			V _{DDd} /2		V
Input voltage		V _{IH}		0.7V _{DDd}			V
		V _{IL}				0.3V _{DDd}	V
Input amplitude		V _{IN}	f _{max} 50MHz sine wave	0.3			V _{p-p}

Note) Input voltage is the input voltage characteristics for direct input from an external source. Input amplitude is the input amplitude characteristics in the case of input through a capacitor.

Switching Characteristics(V_H = 15.0V, V_M = GND, V_L = -7.5V)

Item	Symbol	Conditions	Min.	Typ.	Max.	Unit
Rise time	TTLM	V _L to V _M	200	350	500	ns
	TTMH	V _M to V _H	200	350	500	ns
	TTLH	V _L to V _H	30	60	90	ns
Fall time	TTML	V _M to V _L	200	350	500	ns
	TTHM	V _H to V _M	200	350	500	ns
	TTHL	V _H to V _L	30	60	90	ns
Output noise voltage	VCLH				1.0	V
	VCLL				1.0	V
	VCMH				1.0	V
	VCML				1.0	V

Notes)

- 1) The MOS structure of this IC has a low tolerance for static electricity, so full care should be given for measures to prevent electrostatic discharge.
- 2) For noise and latch-up countermeasures, be sure to connect a by-pass capacitor (0.1μF or more) between each power supply pin (V_H, V_L) and GND.
- 3) To protect the CCD image sensor, clamp the SUB pin output at V_H before input to the CCD image sensor.

Switching Waveforms

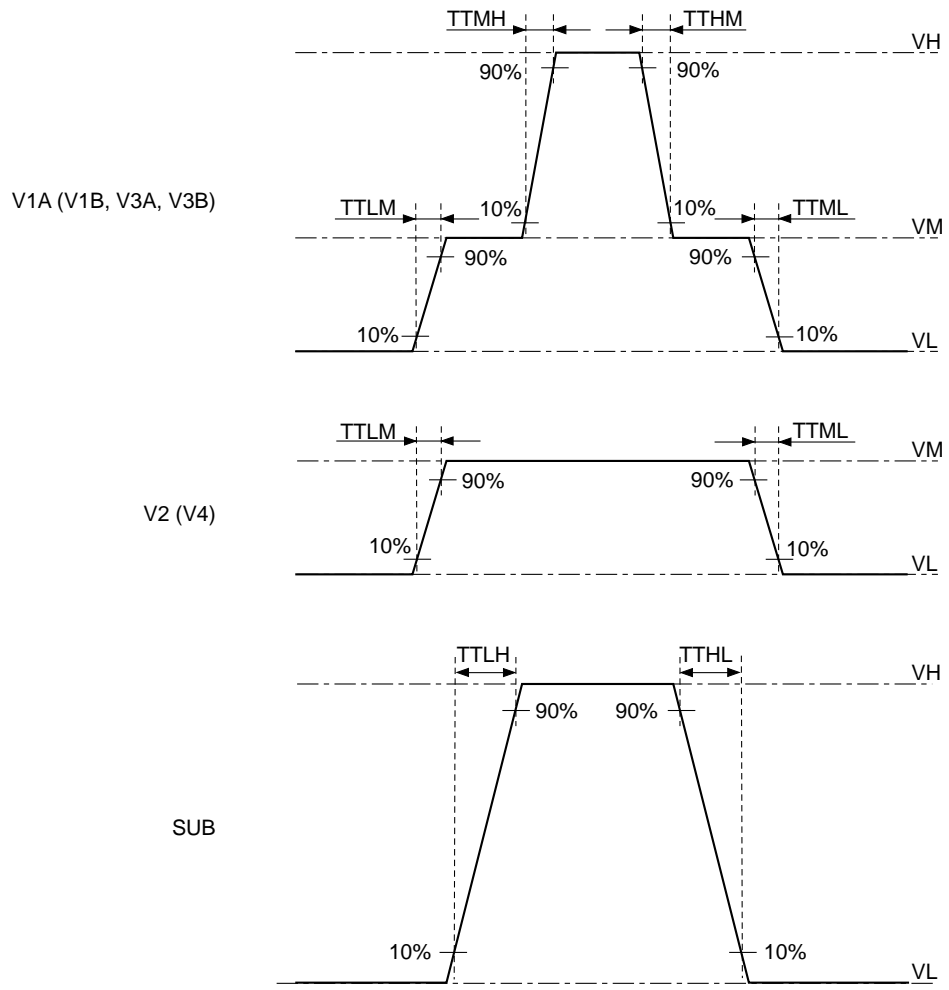

Waveform Noise

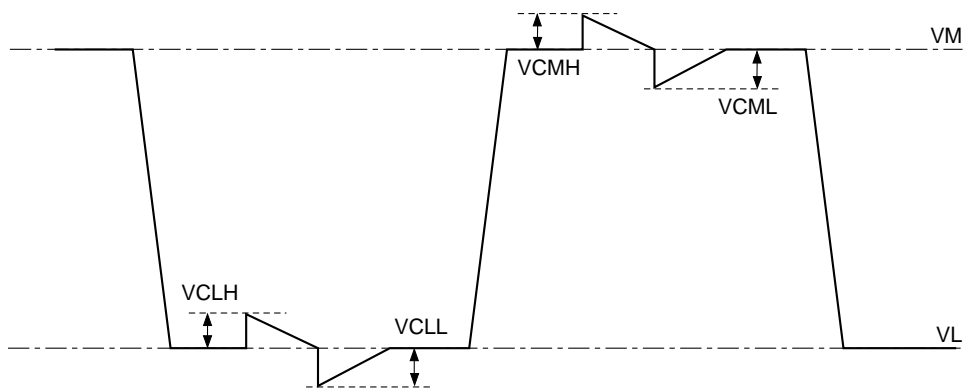

Measurement Circuit

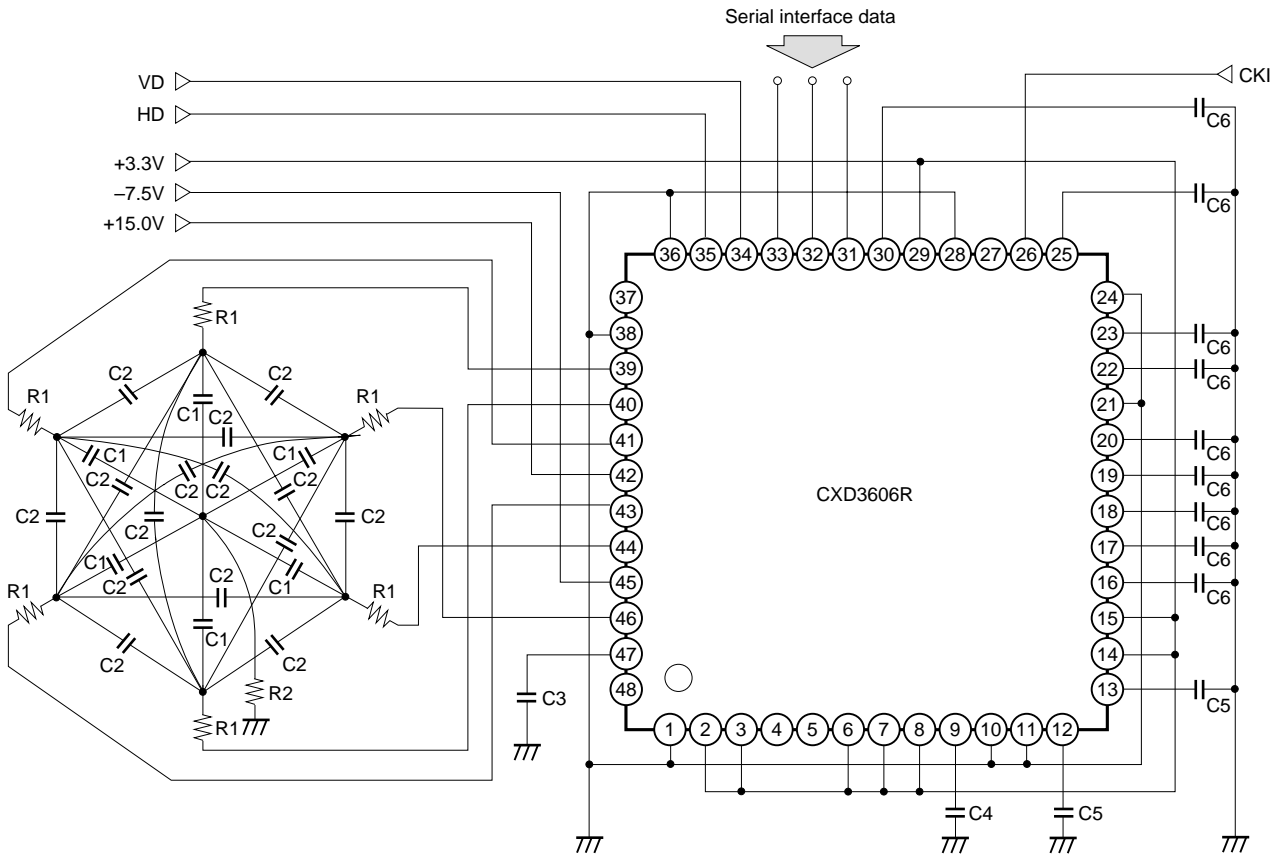

- | | | | | | |
|-----------|----------|----------|--------|----------|---------|
| C1 3300pF | C2 560pF | C3 820pF | C4 8pF | C5 215pF | C6 10pF |
| R1 30Ω | R2 10Ω | | | | |

AC Characteristics

AC characteristics between the serial interface clocks

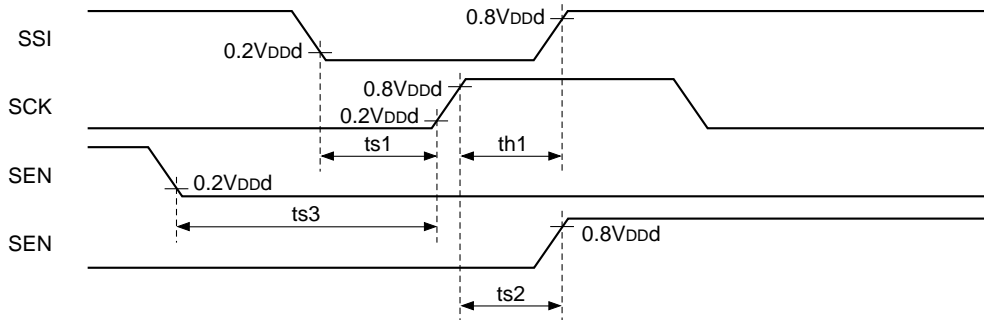

(Within the recommended operating conditions)

Symbol	Definition	Min.	Typ.	Max.	Unit
ts1	SSI setup time, activated by the rising edge of SCK	20			ns
th1	SSI hold time, activated by the rising edge of SCK	20			ns
ts2	SCK setup time, activated by the rising edge of SEN	20			ns
ts3	SEN setup time, activated by the rising edge of SCK	20			ns

Serial interface clock internal loading characteristics (1)

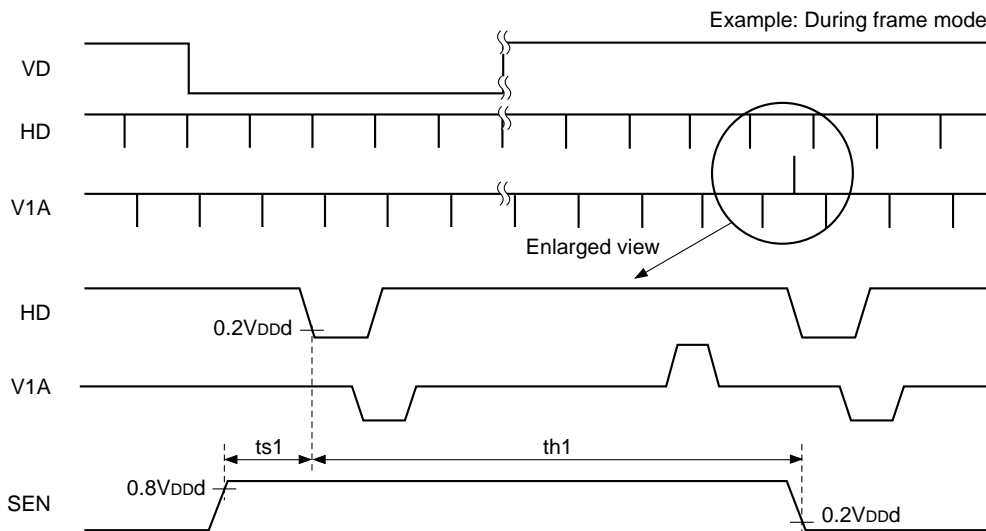

* Be sure to maintain a constantly high SEN logic level near the falling edge of the HD in the horizontal period during which V1A/B and V3A/B values take the ternary value and during that horizontal period.

(Within the recommended operating conditions)

Symbol	Definition	Min.	Typ.	Max.	Unit
ts1	SEN setup time, activated by the falling edge of HD	0			ns
th1	SEN hold time, activated by the falling edge of HD	113			μs

Serial interface clock internal loading characteristics (2)

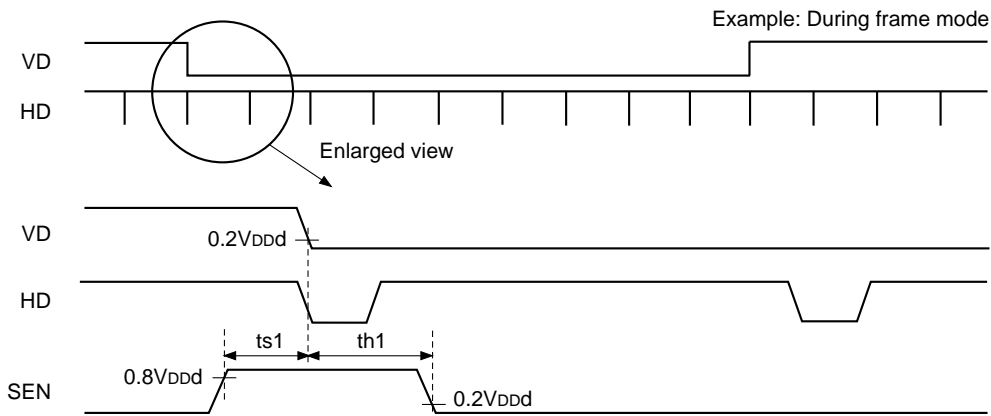

* Be sure to maintain a constantly high SEN logic level near the falling edge of VD.

(Within the recommended operating conditions)

Symbol	Definition	Min.	Typ.	Max.	Unit
ts1	SEN setup time, activated by the falling edge of VD	0			ns
th1	SEN hold time, activated by the falling edge of VD	200			ns

Serial interface clock output variation characteristics

Normally, the serial interface data is loaded to the CXD3606R at the timing shown in "Serial interface clock internal loading characteristics (1)" above. However, one exception to this is when the data such as STB is loaded to the CXD3606R and controlled at the rising edge of SEN. See "Description of Operation".

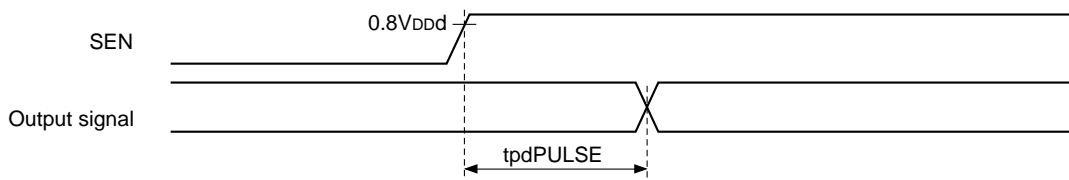

(Within the recommended operating conditions)

Symbol	Definition	Min.	Typ.	Max.	Unit
tpdPULSE	Output signal delay, activated by the rising edge of SEN	15		100	ns

RST loading characteristics

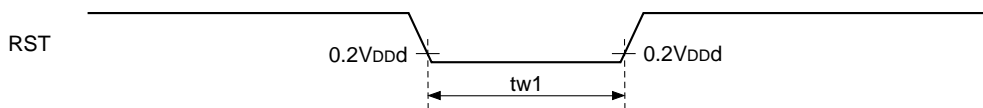

(Within the recommended operating conditions)

Symbol	Definition	Min.	Typ.	Max.	Unit
tw1	RST pulse width	28			ns

VD and HD phase characteristics

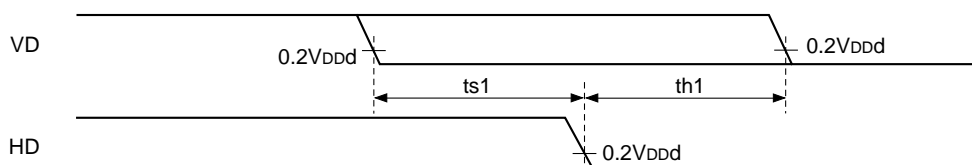

(Within the recommended operating conditions)

Symbol	Definition	Min.	Typ.	Max.	Unit
ts1	VD setup time, activated by the falling edge of HD	0			ns
th1	VD hold time, activated by the falling edge of HD	0			ns

HD loading characteristics

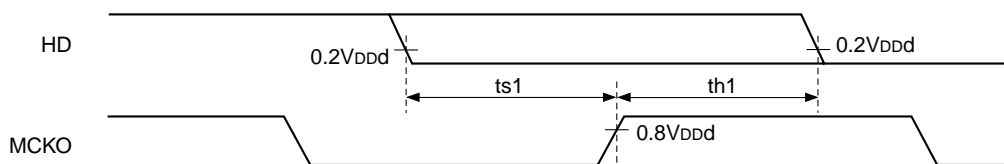

MCKO load capacitance = 10pF

(Within the recommended operating conditions)

Symbol	Definition	Min.	Typ.	Max.	Unit
ts1	HD setup time, activated by the rising edge of MCKO	20			ns
th1	HD hold time, activated by the rising edge of MCKO	0			ns

Output variation characteristics

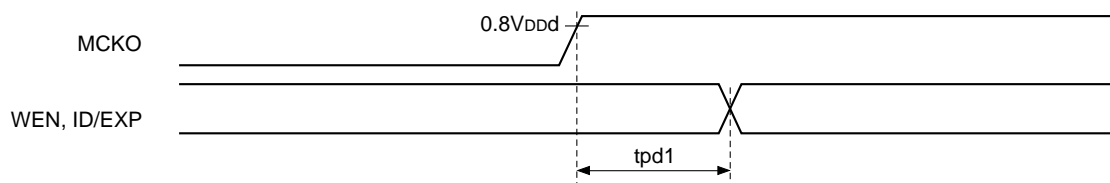

WEN and ID/EXP load capacitance = 10pF

(Within the recommended operating conditions)

Symbol	Definition	Min.	Typ.	Max.	Unit
tpd1	Time until the above outputs change after the rise of MCKO	25		70	ns

Description of Operation

Pulses output from the CXD3606R are controlled mainly by the **RST** pin and by the serial interface data. The Pin Status Table is shown below, and the details of serial interface control are described on the following pages.

Pin Status Table

Pin No.	Symbol	CAM	SLP	STB	RST	Pin No.	Symbol	CAM	SLP	STB	RST
1	V _{SS1}	—				25	CKO	ACT	ACT	L	ACT
2	RST	ACT	ACT	ACT	L	26	CKI	ACT	ACT	ACT	ACT
3	SNCSL	ACT	ACT	ACT	ACT	27	OSCO	ACT	ACT	ACT	ACT
4	ID/EXP	ACT	L	L	L	28	OSCI	ACT	ACT	ACT	ACT
5	WEN	ACT	L	L	L	29	V _{DD5}	—			
6	SSGSL	ACT	ACT	ACT	ACT	30	MCKO	ACT	ACT	L	ACT
7	V _{DD1}	—				31	SSI	ACT	ACT	ACT	DIS
8	V _{DD2}	—				32	SCK	ACT	ACT	ACT	DIS
9	RG	ACT	L	L	ACT	33	SEN	ACT	ACT	ACT	DIS
10	V _{SS2}	—				34	VD* ¹	ACT	L	L	H
11	V _{SS3}	—				35	HD* ¹	ACT	L	L	H
12	H1	ACT	L	L	ACT	36	V _{SS6}	—			
13	H2	ACT	L	L	ACT	37	TEST1	—			
14	V _{DD3}	—				38	VM	—			
15	V _{DD4}	—				39	V2	ACT	VM	VM	VM
16	XSHP	ACT	L	L	ACT	40	V4	ACT	VM	VM	VL
17	XSHD	ACT	L	L	ACT	41	V1A	ACT	VH	VH	VM
18	XRS	ACT	L	L	ACT	42	VH	—			
19	PBLK	ACT	L	L	H	43	V1B	ACT	VH	VH	VM
20	CLPDM	ACT	L	L	H	44	V3A	ACT	VH	VH	VL
21	V _{SS4}	—				45	VL	—			
22	OBCLP	ACT	L	L	H	46	V3B	ACT	VH	VH	VL
23	ADCLK	ACT	L	L	ACT	47	SUB	ACT	VH	VH	VL
24	V _{SS5}	—				48	TEST2	—			

*¹ It is for output. For input, all items are "ACT".

Note) ACT means that the circuit is operating, and DIS means that loading is stopped. L indicates a low output level, and H a high output level in the controlled status.

Also, VH, VM and VL indicate the voltage levels applied to VH (Pin 42), VM (Pin 38) and VL (Pin 45), respectively, in the controlled status.

Serial Interface Control

The CXD3606R basically loads and reflects the serial interface data sent in the following format in the readout portion at the falling edge of HD. Here, readout portion specifies the horizontal period during which V1A/B and V3A/B, etc. take the ternary value.

Note that some items reflect the serial interface data at the falling edge of VD or the rising edge of SEN.

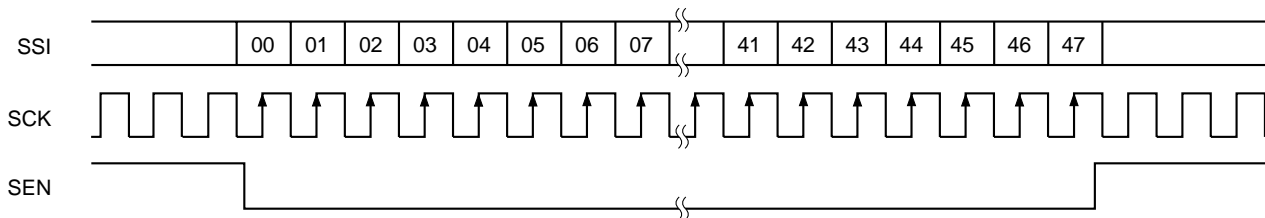

These are two categories of serial interface data : the CXD3606R drive control data (hereafter “control data”) and electronic shutter data (hereafter “shutter data”).

The details of each data are described below.

Control Data

Data	Symbol	Function	Data = 0	Data = 1	RST
D00 to D07	CHIP	Chip enable	10000001 → Enabled Other values → Disabled		All 0
D08 D09	CTG	Category switching	See [D08] to [D09] CTG.		All 0
D10 to D12	MODE	Drive mode switching	See [D10] to [D12] MODE.		All 0
D13	SMD	Electronic shutter mode switching*1	OFF	ON	0
D14	HTSG	HTSG control switching*1	OFF	ON	0
D15	PTSG	Internal SSG function switching	NTSC	PAL	0
D16 to D31	—	—	—	—	All 0
D32	FGOB	Wide OBCLP generation switching*2	OFF	ON	0
D33	EXP	ID/EXP output switching	ID	EXP	0
D34 D35	PTOB	OBCLP waveform pattern switching	See [D34] to [D35] PTOB.		All 0
D36 D37	LDAD	ADCLK logic phase adjustment	See [D36] to [D37] LDAD.		1 0
D38 D39	STB	Standby control	See [D38] to [D39] STB.		All 0
D40 to D47	—	—	—	—	All 0

*1 See [D13] SMD.

*2 See [D32] FGOB.

Shutter Data

Data	Symbol	Function	Data = 0	Data = 1	RST
D00 to D07	CHIP	Chip enable	10000001 → Enabled Other values → Disabled		All 0
D08 D09	CTG	Category switching	See [D08] to [D09] CTG.		All 0
D10 to D19	SVD	Electronic shutter vertical period specification	See [D10] to [D19] SVD.		All 0
D20 to D31	SHD	Electronic shutter horizontal period specification	See [D20] to [D31] SHD.		All 0
D32 to D41	SPL	High-speed shutter position specification	See [D32] to [D41] SPL.		All 0
D42 to D47	—	—	—	—	All 0

Detailed Description of Each Data

Shared data: **D08** to **D09** CTG [Category]

Of the data provided to the CXD3606R by the serial interface, the CXD3606R loads **D10** and subsequent data to each data register as shown in the table below according to the combination of **D08** and **D09**.

D09	D08	Description of operation
0	0	Loading to control data register
0	1	Loading to shutter data register
1	X	Test mode

Note that the CXD3606R can apply these categories consecutively within the same vertical period. However, care should be taken as the data is overwritten if the same category is applied.

Control data: **D10** to **D12** MODE [Drive mode]

The CXD3606R drive mode can be switched as follows. However, the drive mode bits are located to the CXD3606R and reflected at the falling edge of VD.

D12	D11	D10	Description of operation
0	0	0	Draft mode (sextuple speed: default)
0	0	1	Frame mode (A field readout)
0	1	0	Frame mode (B field readout)
0	1	1	Frame mode
1	0	X	AF1 mode
1	1	X	AF2 mode

Control data: **D15** PTSG [Internal SSG output pattern]

The CXD3606R internal SSG output pattern can be switched as follows. However, the internal SSG output pattern bits are loaded to the CXD3606R and reflected at the falling edge of VD.

D15	Description of Operation
0	NTSC equivalent pattern output
1	PAL equivalent pattern output

VD period in each pattern is defined as follows. However, note that the HD period also changes according to the mode.

	Frame mode	Draft mode	AF1 mode	AF2 mode
NTSC equivalent pattern	885H + 810ck	285H + 1455ck × 2	142H + 1384ck + 1383ck	71H + 1384ck
PAL equivalent pattern	884H + 1104ck	342H + 2592ck	171H + 1296ck	85H + 1960ck

See the Timing Charts for the actual operation.





Control data: D32 FGOB [Wide OBCLP generation]

This controls wide OBCLP generation during the vertical OPB period. See the Timing Charts for the actual operation. The default is "OFF".

D32	Description of operation
0	Wide OBCLP generation OFF
1	Wide OBCLP generation ON

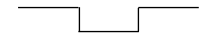
Control data: D34 to D35 PTOB [OBCLP waveform pattern]

This indicates the OBCLP waveform pattern. The default is "Normal".

D35	D34	Waveform pattern
0	0	 (Normal)
0	1	 (Shifted rearward)
1	0	 (Shifted forward)
1	1	 (Wide)

Control data: D36 to D37 LDAD [ADCLK logic phase]

This indicates the ADCLK logic phase adjustment data. The default is "90°" relative to MCKO.

D37	D36	Degree of adjustment (°)
0	0	0
0	1	90
1	0	180
1	1	270

Control data : D38 to D39 STB [Standby]

The operating mode is switched as follows. However, the standby bits are loaded to the CXD3606R and control is applied immediately at the rising edge of SEN.

D39	D38	Symbol	Operating mode
X	0	CAM	Normal operating mode
0	1	SLP	Sleep mode
1	1	STB	Standby mode

See the Pin Status Table for the pin status in each mode.

Control data/shutter data: [Electronic shutter]

The CXD3606R realizes various electronic shutter functions by using control data [D13] SMD and [D14] HTSG and shutter data [D10] to [D19] SVD, [D20] to [D31] SHD and [D32] to [D41] SPL.

These functions are described in detail below.

First, the various modes are shown below. These modes are switched using control data [D13] SMD.

D13	Description of operation
0	Electronic shutter stopped mode
1	Electronic shutter mode

The electronic shutter data is expressed as shown in the table below using [D20] to [D31] SHD as an example. However, MSB (D31) is a reserve bit for the future specification, and it is handled as a dummy on this IC.

MSB								LSB			
D31	D30	D29	D28	D27	D26	D25	D24	D23	D22	D21	D20
X	0	0	1	1	1	0	0	0	0	1	1
	↓				↓				↓		
	1				C				3		

→ SHD is expressed as [1C3h].

[Electronic shutter stopped mode]

During this mode, all shutter data items are invalid.

SUB is not output in this mode, so the shutter speed is the accumulation time for one field.

[High-speed/low-speed shutter mode]

During this mode, the shutter data items have the following meanings.

Symbol	Data	Description
SVD	[D10] to [D19]	Number of vertical periods specification (000h ≤ SVD ≤ 3FFh)
SHD	[D20] to [D31]	Number of horizontal periods specification (000h ≤ SHD ≤ 7FFh)
SPL	[D32] to [D41]	Vertical period specification for high-speed shutter operation (000h ≤ SPL ≤ 3FFh)

Note)

The bit data definition area is assured in terms of the CXD3606R functions, and does not assure the CCD characteristics.

The period during which SVD and SHD are specified together is the shutter speed. An image of the exposure time calculation formula is shown below. In actual operation, the precise exposure time is calculated from the operating frequency, VD and HD periods, decoding value during the horizontal period, and other factors.

$$(\text{Exposure time}) = \text{SVD} + \{(\text{number of HD per 1V}) - (\text{SHD} + 1)\}$$

Concretely, when specifying high-speed shutter, SVD is set to "000h". (See the figure.) During low-speed shutter, or in other words when SVD is set to "001h" or higher, the serial interface data is not loaded until this period is finished.

The vertical period indicated here corresponds to one field in each drive mode. In addition, the number of horizontal periods applied to SHD can be considered as (number of SUB pulses – 1).

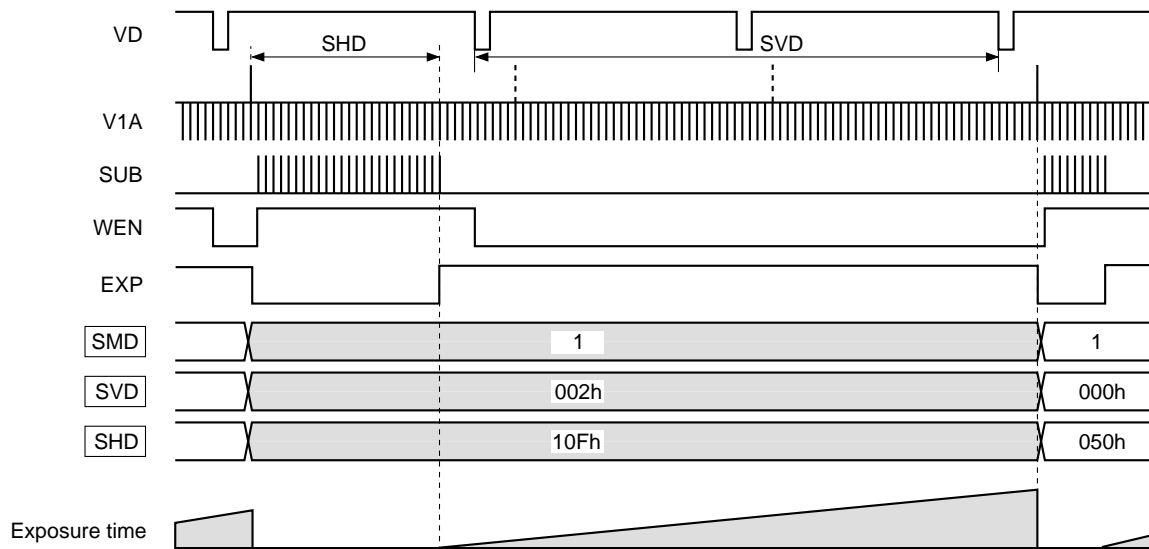

Further, SPL can be used during this mode to specify the SUB output at the desired vertical period during the low-speed shutter period.

In the case below, SUB is output based on SHD at the SPL vertical period out of (SVD + 1) vertical periods.

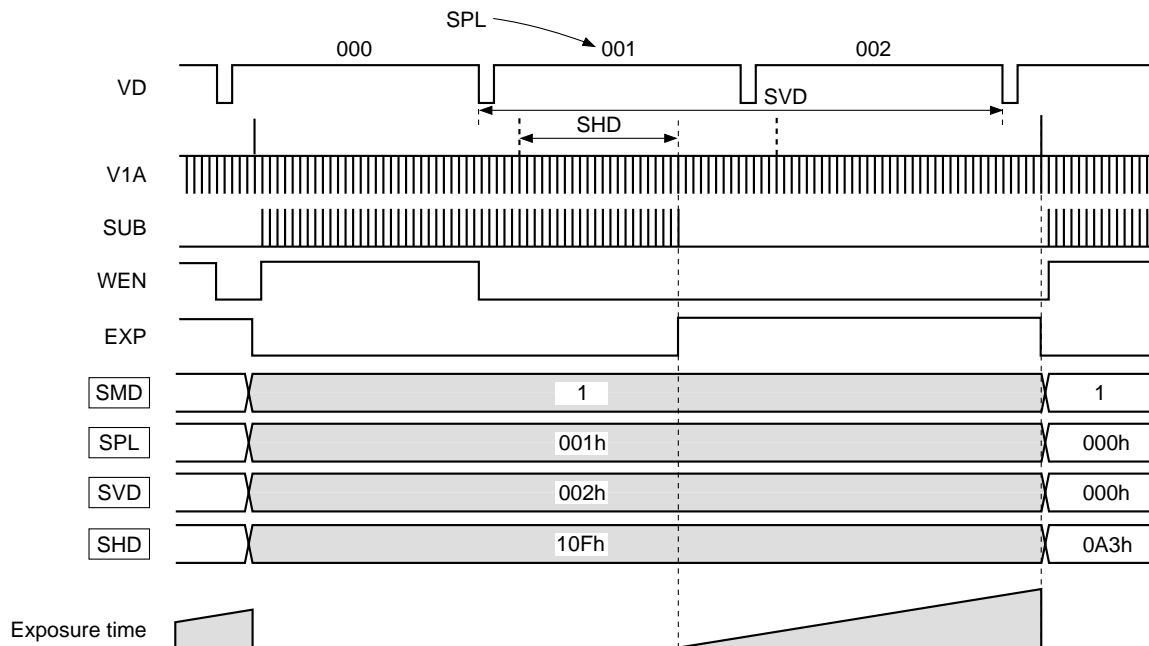

Incidentally, SPL is counted as "000h", "001h", "002h" and so on in conformance with SVD. At this time, even if $SPL > SVD$ is set, operation conforms to the state when $SPL = SVD$.

Using this function it is possible to achieve smooth exposure time transitions when changing from low-speed shutter to high-speed shutter or vice versa.

[HTSG control mode]

This mode controls the V1A/B and V3A/B ternary level outputs (readout pulse block) using [D14] HTSG. When control is applied, V pulse modulation does not occur during the readout period, and only normal V transfer is performed.

D14	Description of operation
0	Readout pulse (SG) normal operation
1	HTSG control mode

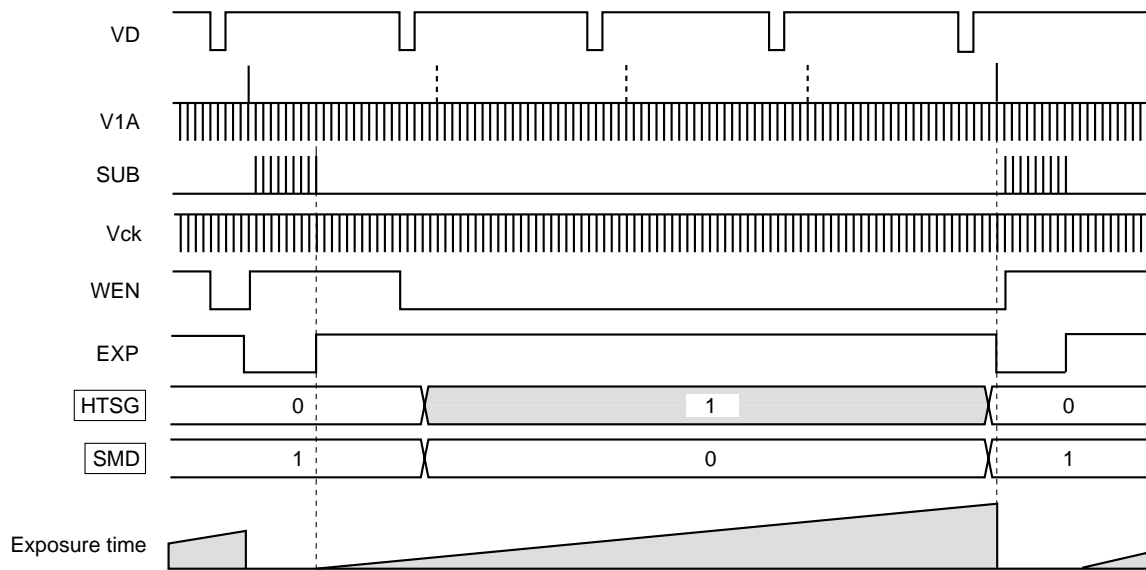

[EXP pulse]

The ID/EXP pin (Pin 4) output can be switched between the ID pulse or the EXP pulse using [D33] EXP. The default is the "ID" pulse. See the Timing Charts for the ID pulse. The EXP pulse indicates the exposure time when it is high. In draft mode, the transition point is midpoint value (1443ck) of the last SUB pulse falling edge and each V1A/B and V3A/B ternary output falling edge. When there is no SUB pulse, the later ternary output falling edge (1538ck) is used. In frame mode, the transition point is the last SUB pulse falling edge, and each V1A/B and V3A/B ternary level output falling edge (1348ck). When there is no SUB pulse, the V pulse modulation falling edge (1386ck) immediately after the ternary output is used. In addition, switching from the ID pulse to the EXP pulse is performed at the ID reset timing (the ID transition point during the horizontal period of each V1A/B and V3A/B ternary level output), and the EXP pulse is reset low at this point. See the EXP pulse indicated in the explanatory diagrams under [Electronic shutter] for an image of operation.

Chart-1 Vertical Direction Timing Chart
Applicable CCD image sensor
 • ICX412

MODE
 Frame mode

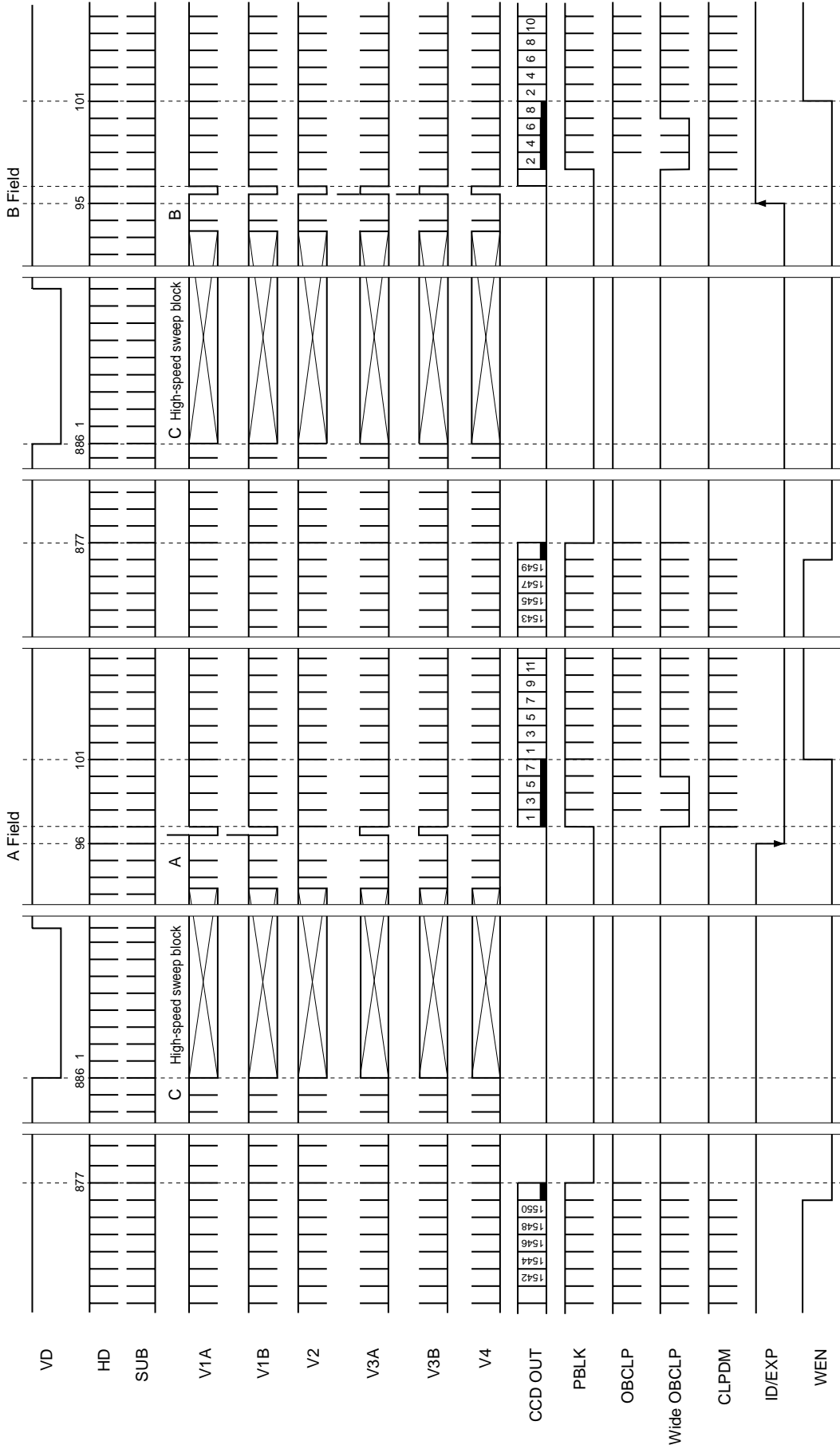

* The number of SUB pulses is determined by the serial interface data. This chart shows the case where SUB pulses are output in each horizontal period.
 * ID/EXP of this chart shows ID. ID is low for lines where CCD OUT contains the R component, and high for lines where CCD OUT contains the B component.
 * The high-speed sweep block is fixed to 1560 stages.
 * VD of this chart is NTSC equivalent pattern (885H + 810ck units). For PAL equivalent pattern, it is 884H + 1104ck units.

Applicable CCD image sensor
• ICX412

MODE
Draft mode

Chart-2 Vertical Direction Timing Chart

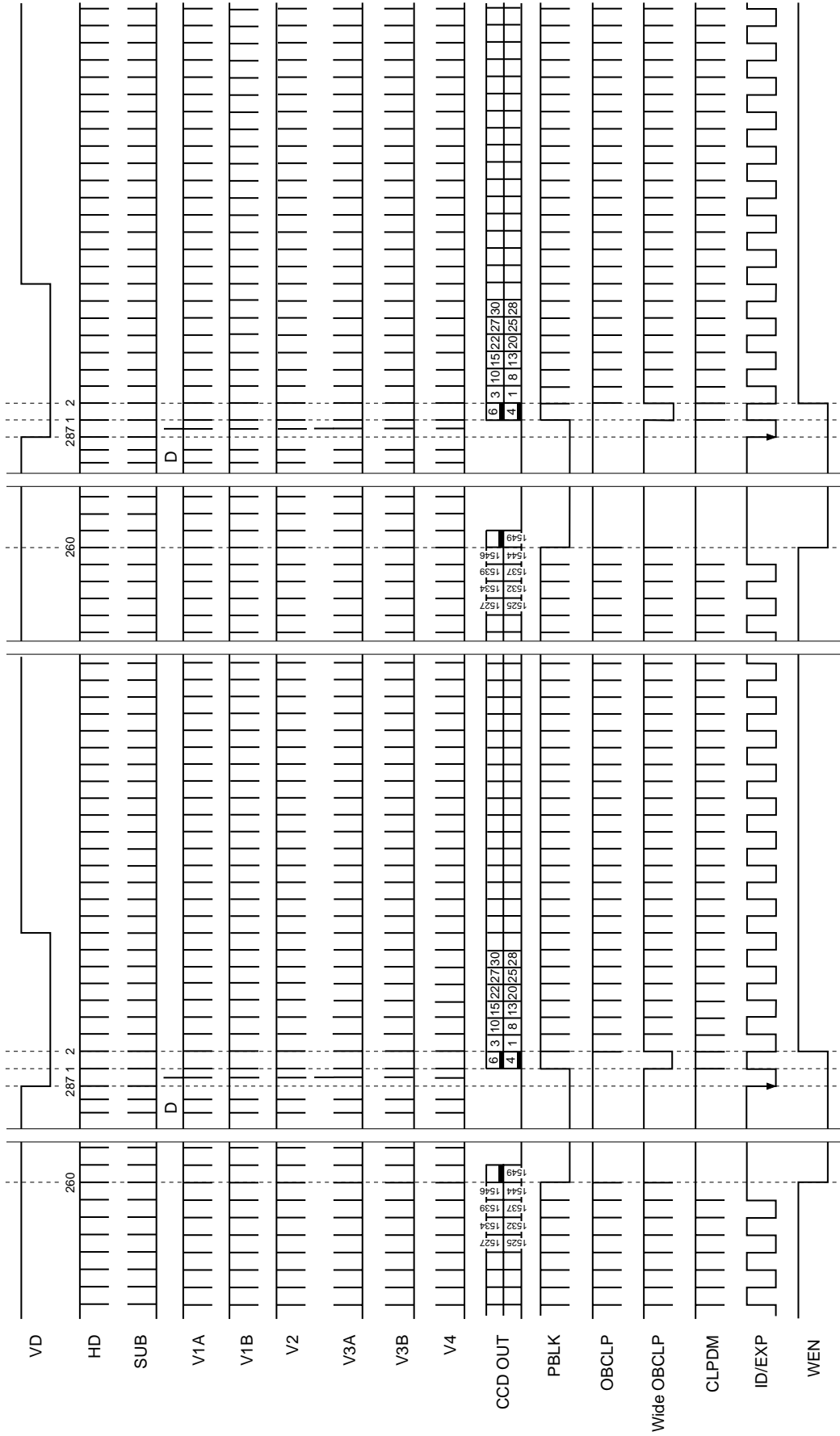

* The number of SUB pulses is determined by the serial interface data. This chart shows the case where SUB pulses are output in each horizontal period.
 * ID/EXP of this chart shows ID. ID is low for lines where CCD OUT contains the R component, and high for lines where CCD OUT contains the B component.
 * VD of this chart is NTSC equivalent pattern (285H + 1455ck units). For PAL equivalent pattern, it is 342H + 2592ck units.

Applicable CCD image sensor
• ICX412

MODE
AF1 mode

Chart-3 Vertical Direction Timing Chart

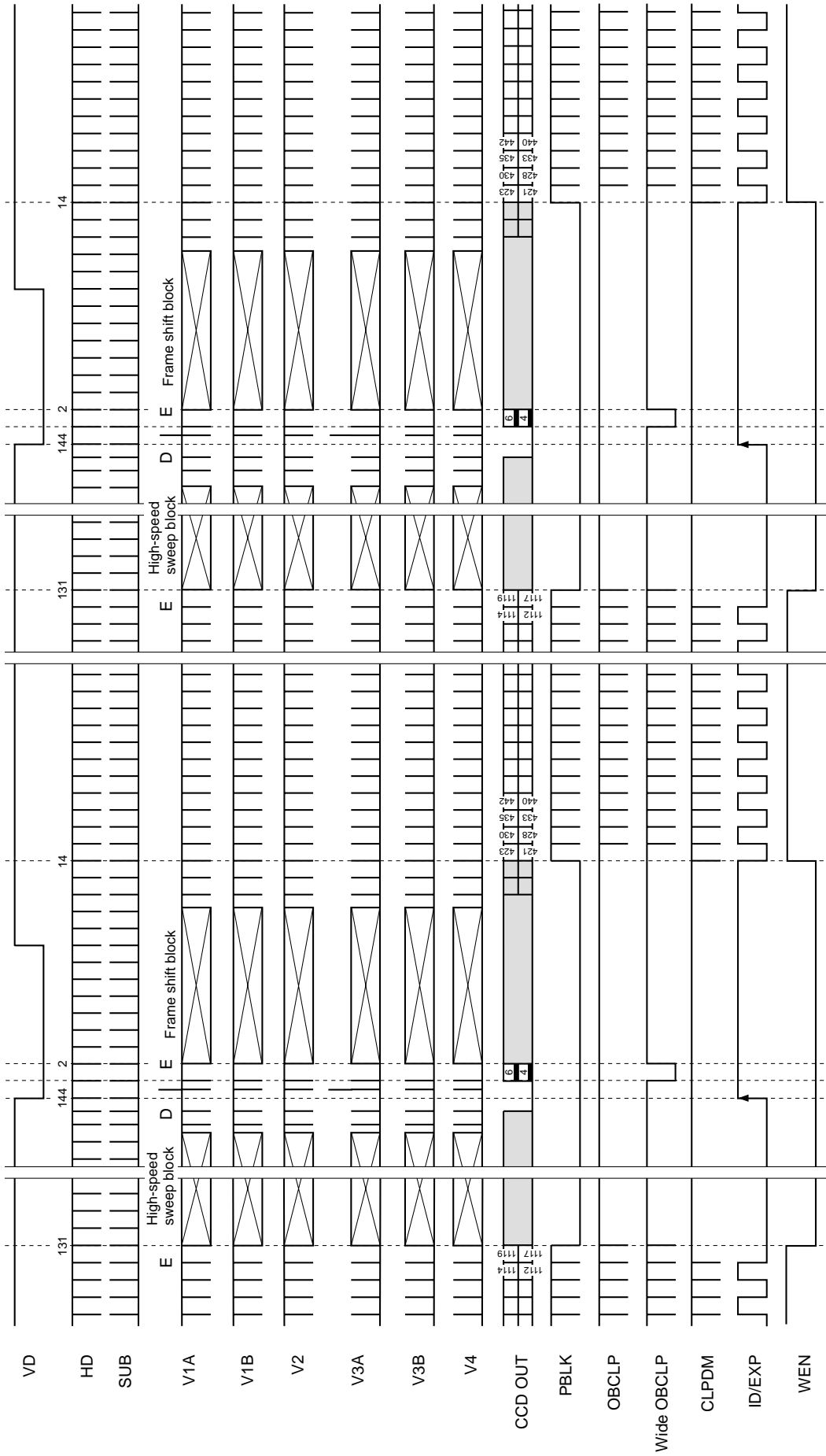

* The number of SUB pulses is determined by the serial interface data. This chart shows the case where SUB pulses are output in each horizontal period.

* ID/EXP of this chart shows ID. ID is low for lines where CCD OUT contains the R component, and high for lines where CCD OUT contains the B component.

* 75 stages are fixed for high-speed sweep block; 68 stages are fixed for frame shift block.

* VD of this chart is NTSC equivalent pattern (142H + 1384ck + 1383ck units). For PAL equivalent pattern it is 171H + 1296ck units, and the high-speed sweep block starts from 159H.

Applicable CCD image sensor
• ICX412

MODE
AF2 mode

Chart-4 Vertical Direction Timing Chart

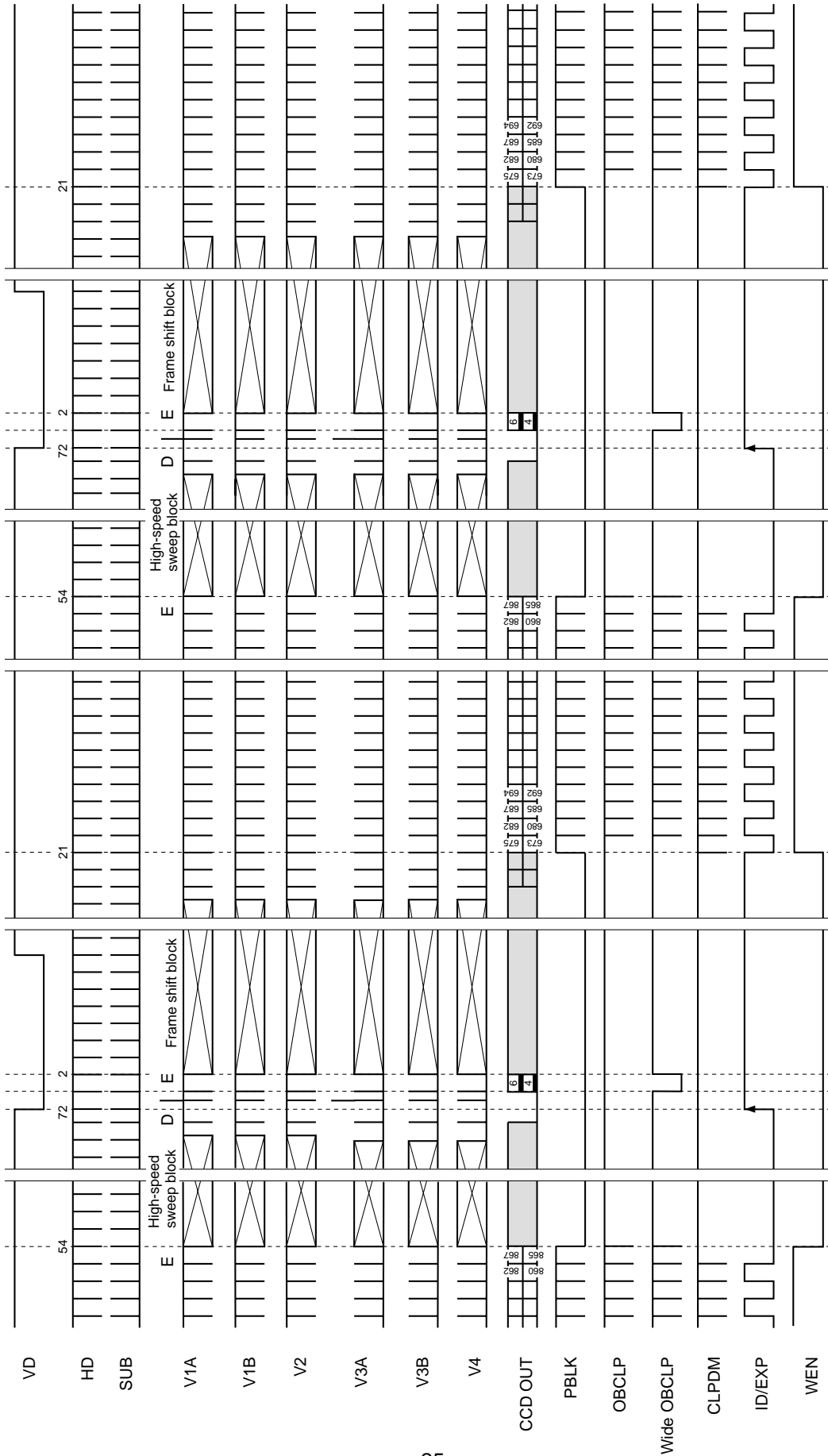

* The number of SUB pulses is determined by the serial interface data. This chart shows the case where SUB pulses are output in each horizontal period.
 * ID/EXP of this chart shows ID. ID is low for lines where CCD OUT contains the R component, and high for lines where CCD OUT contains the B component.
 * 116 stages are fixed for high-speed sweep block; 110 stages are fixed for frame shift block.
 * VD of this chart is NTSC equivalent pattern (71H + 1384ck units). For PAL equivalent pattern, it is 85H + 1960ck units, and the high-speed sweep block starts from 68H. However, in this case the frame rate for NTSC equivalent pattern is 0.5ck longer than for 1/120s.

Applicable CCD image sensor
• ICX412

MODE
Frame mode

Chart-5 Horizontal Direction Timing Chart

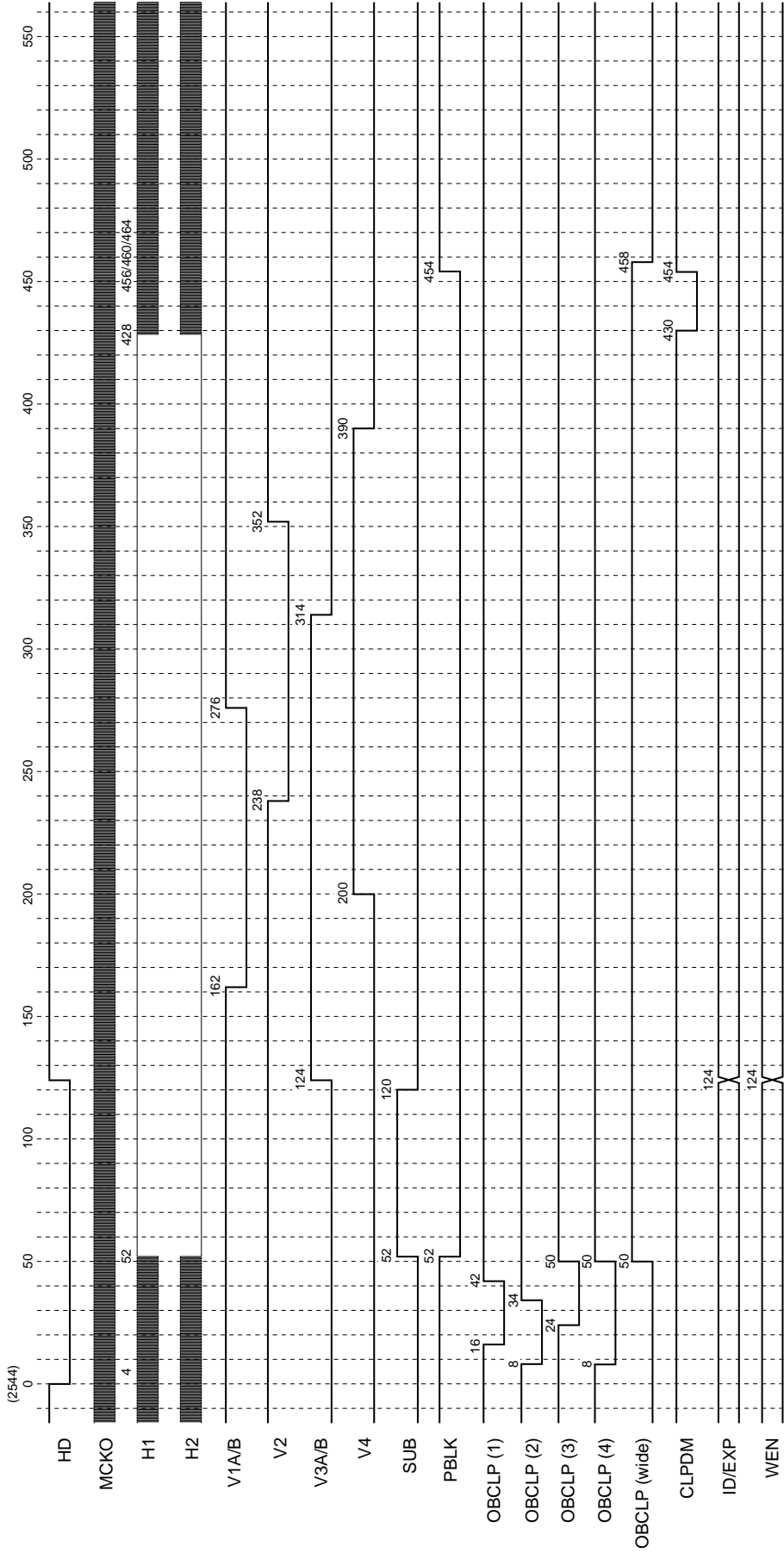

- * The HD of this chart indicates the actual CXD3606R load timing.
- * The numbers at the output pulse transition points indicate the count at the MCKO rise from the fall of HD.
- * The HD fall period should be between approximately 2.3 to 19.0µs (when the drive frequency is 22.5MHz). This chart shows a period of 124ck (5.5µs). Internal SSG is at this timing.
- * SUB is output at the timing shown above when output is controlled by the serial interface data.
- * ID/EXP of this chart shows ID, ID/EXP and WEN are output at the timing shown above at the position shown in Chart-1.
- * OBCLP (wide) is output at the above timing at the position indicated in Chart-1.

Chart-6 Horizontal Direction Timing Chart
MODE
 Draft mode, AF1 mode, AF2 mode

Applicable CCD image sensor
 • ICX412

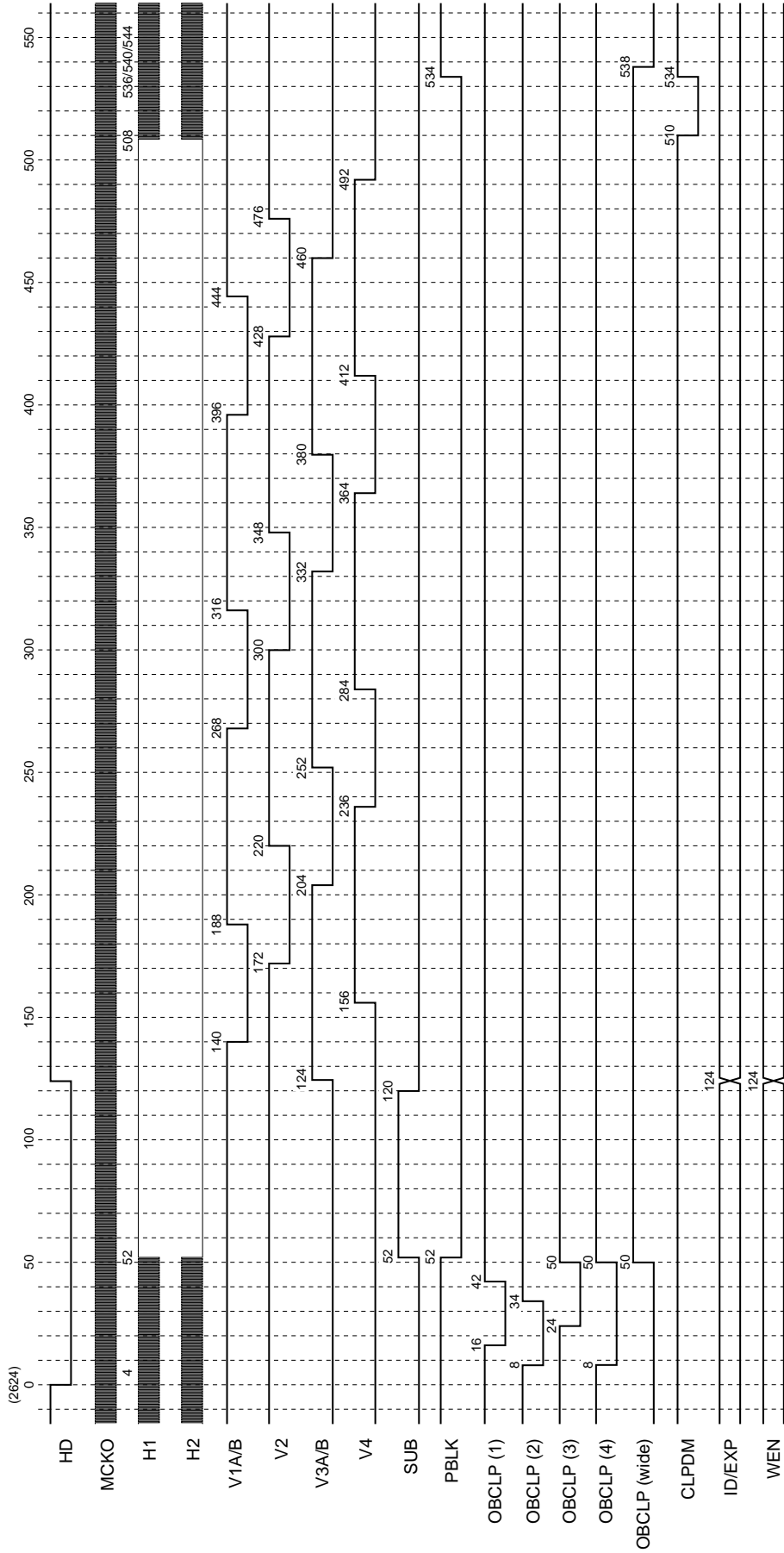

* The HD of this chart indicates the actual CXD3606R load timing.
 * The numbers at the output pulse transition points indicate the count at the MCKO rise from the fall of HD.
 * The HD fall period should be between approximately 2.3 to 19.0µs (when the drive frequency is 22.5MHz). This chart shows a period of 124ck (5.5µs). Internal SSG is at this timing.
 * SUB is output at the timing shown above when output is controlled by the serial interface data.
 * ID/EXP of this chart shows ID, ID/EXP and WEN are output at the timing shown above at the position in Chart-2,3 and 4.
 * OBCLP (wide) is output at the above timing at the position indicated in Chart-2,3 and 4.

Chart-7 Horizontal Direction Timing Chart
(High-speed sweep: C)

MODE
Frame mode

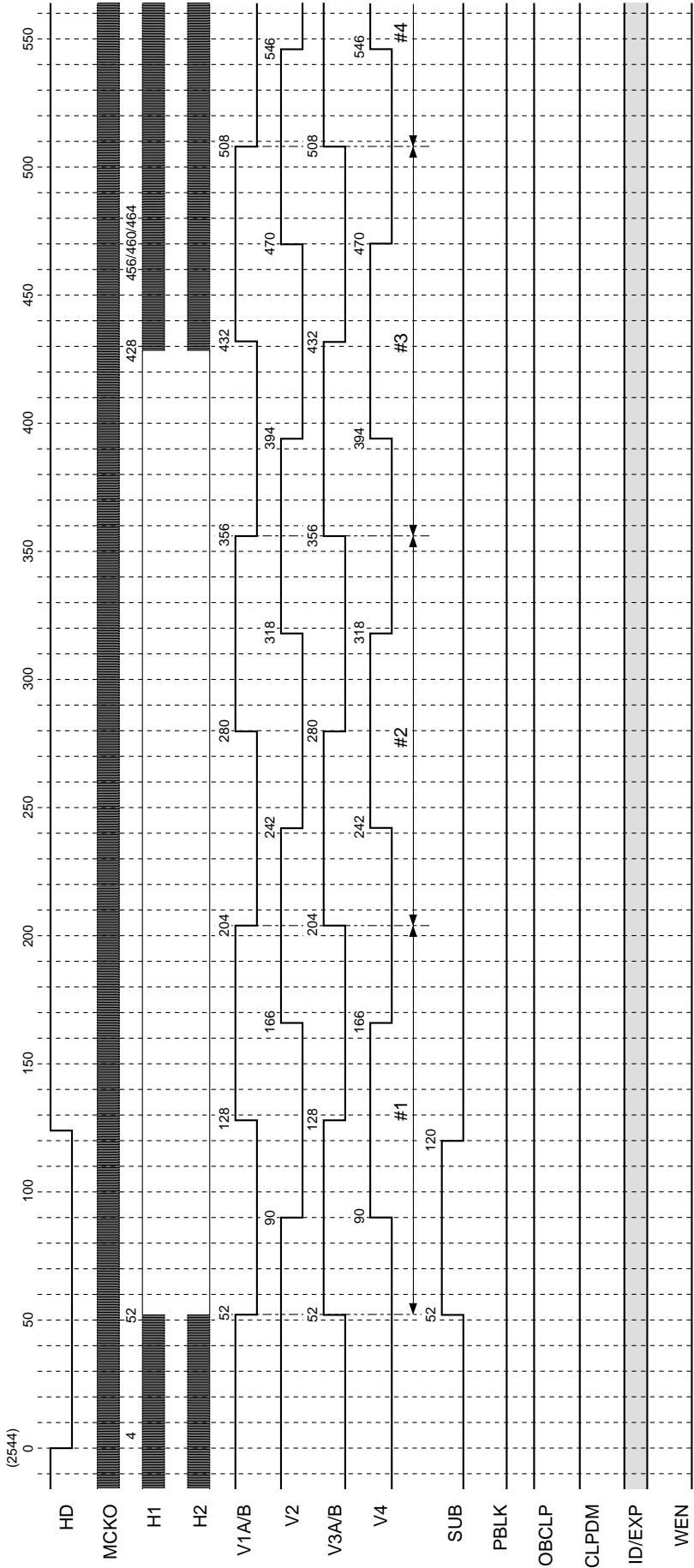

- * The HD of this chart indicates the actual CXD3606R load timing.
- * The numbers at the output pulse transition points indicate the count at the MCKO rise from the fall of HD.
- * The HD fall period should be between approximately 2.3 to 19.0µs (when the drive frequency is 22.5MHz). Internal SSG is at this timing.
- * SUB is output at the timing shown above when output is controlled by the serial interface data.
- * ID/EXP of this chart shows ID.
- * High-speed sweep of V1A/B, V2, V3A/B, V4 is performed up to 98H 580ck (#1560).

Chart-8 Horizontal Direction Timing Chart
 (Frame shift, high-speed sweep: E)

MODE
 AF1 mode, AF2 mode

Applicable CCD image sensor
 • ICX412

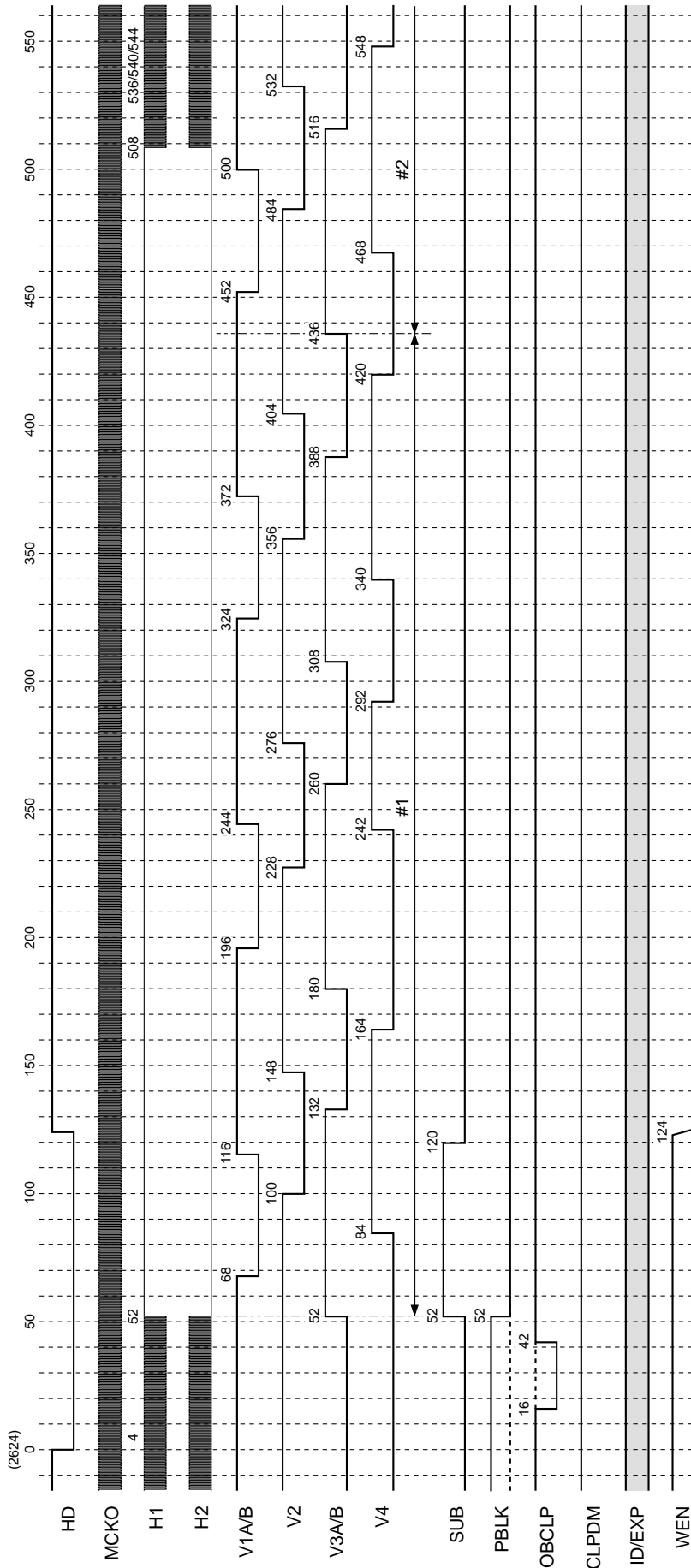

* The HD of this chart indicates the actual CXD3606R load timing.
 * The numbers at the output pulse transition points indicate the count at the MCKO rise from the fall of HD.
 * The HD fall period should be between approximately 2.3 to 19.0μs (when the drive frequency is 22.5MHz). This chart shows a period of 124ck (5.5μs). Internal SSG is at this timing.
 * SUB is output at the timing shown above when output is controlled by the serial interface data.
 * ID/EXP of this chart shows ID, PBLK, OBCLP, ID/EXP and WEN are output at the timing shown above at the position shown in Chart-3 and 4.
 * Frame shift of V1A/B, V2, V3A/B and V4 is performed up to 11H 2548ck (#68) in AF1 mode and 18H 308ck (#110) in AF2 mode.
 In addition, high-speed sweep is performed up to 141H 2612ck (#75) in AF1 mode and 70H 2612ck (#116) in AF2 mode.

Chart-9 Horizontal Direction Timing Chart

Applicable CCD image sensor

- ICX412

MODE

Frame mode

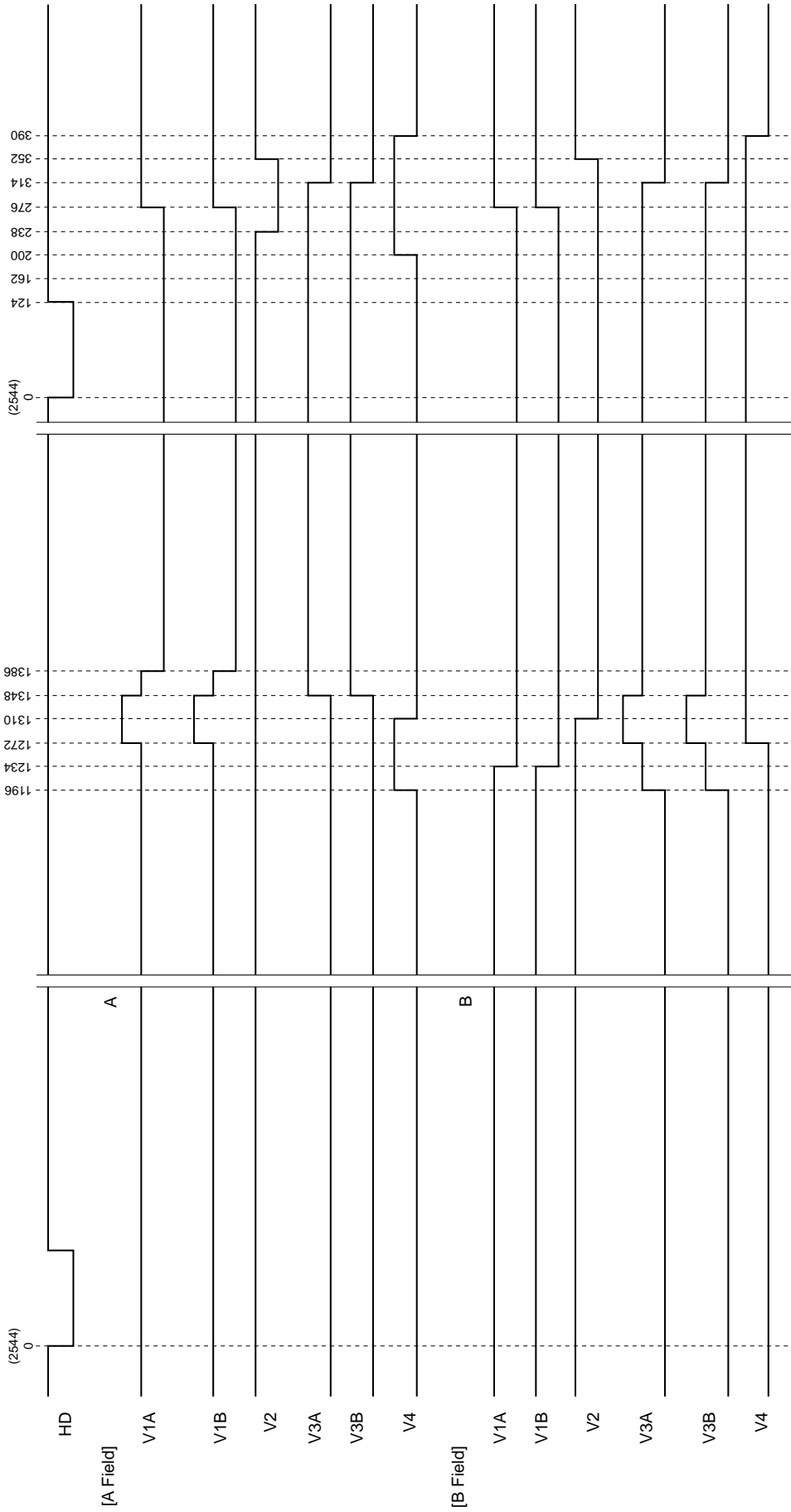

* The HD of this chart indicates the actual CXD3606R load timing.

* The numbers at the output pulse transition points indicate the count at the MCKO rise from the fall of HD.

* The HD fall period should be between approximately 2.3 to 19.0µs (when the drive frequency is 22.5MHz). Internal SSG is at this timing.

Chart-10 Horizontal Direction Timing Chart

Applicable CCD image sensor

- ICX412

MODE

Draft mode, AF1 mode, AF2 mode

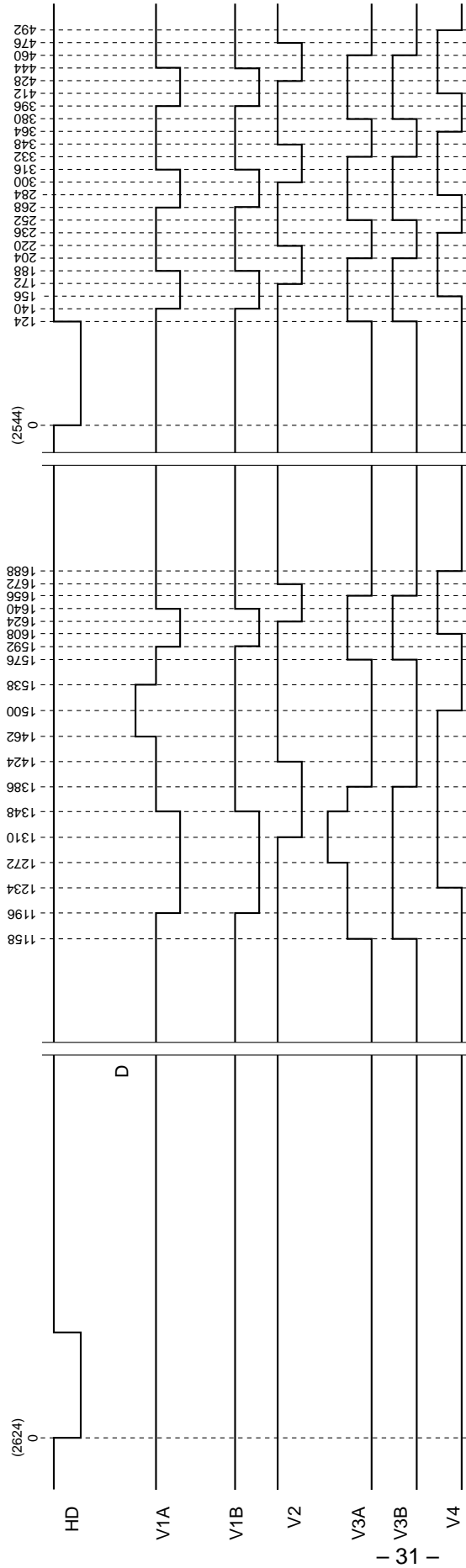

* The HD of this chart indicates the actual CXD3606R load timing.

* The numbers at the output pulse transition points indicate the count at the MCKO rise from the fall of HD.

* The HD fall period should be between approximately 2.3 to 19.0µs (when the drive frequency is 22.5MHz). This chart shows a period of 124ck (5.5µs). Internal SSG is at this timing.

Chart-11 High-Speed Phase Timing Chart

MODE

Applicable CCD image sensor
• ICX412

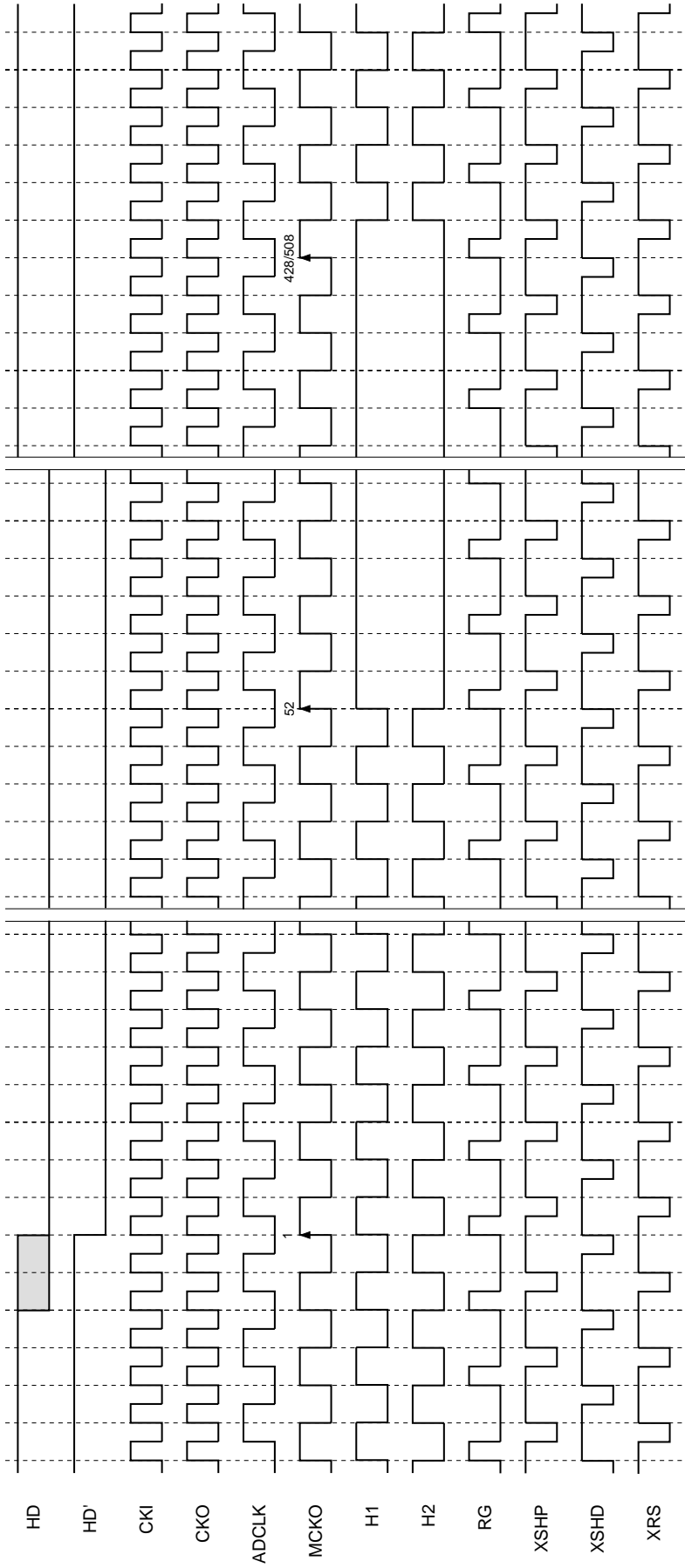

* HD' of this chart indicates the HD which is the actual CXD3606R load timing.
 * The phase relationship of each pulse shows the logical position relationship. For the actual output waveform, a delay is added to each pulse.
 * The logical phase of ADCLK can be specified by the serial interface data.

Applicable CCD image sensor

• ICX412

MODE

Draft → Frame → Draft

Chart-12 Vertical Direction Sequence Chart

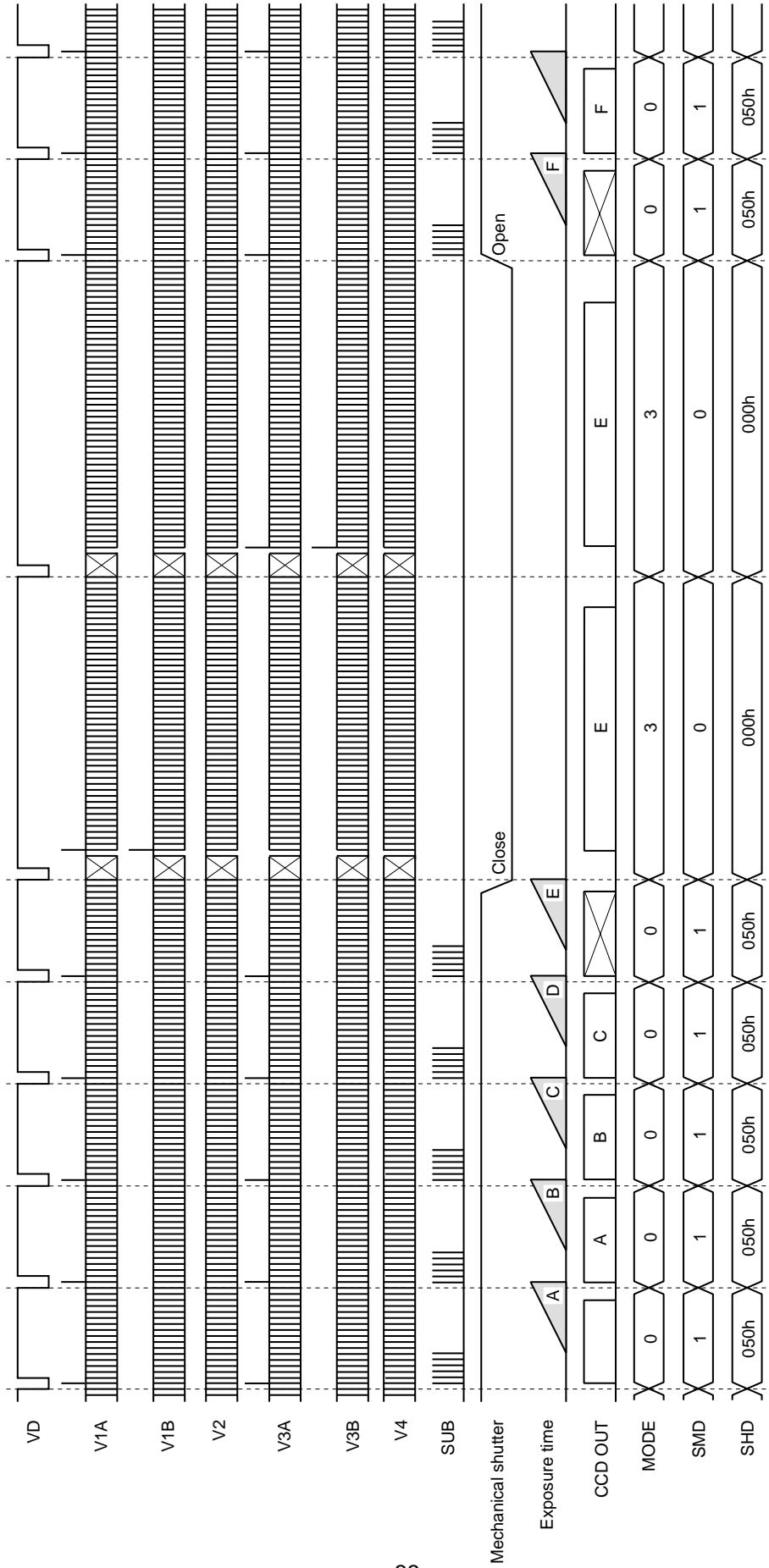

* This chart is a drive timing chart example of electronic shutter normal operation.
 * Data exposed at D includes the blooming component. For details, see the CCD image sensor data sheet.
 * The CXD3606R does not generate the pulse to control mechanical shutter operation.
 * The switching timing of drive mode and electronic shutter data is not the same.

Application Circuit Block diagram

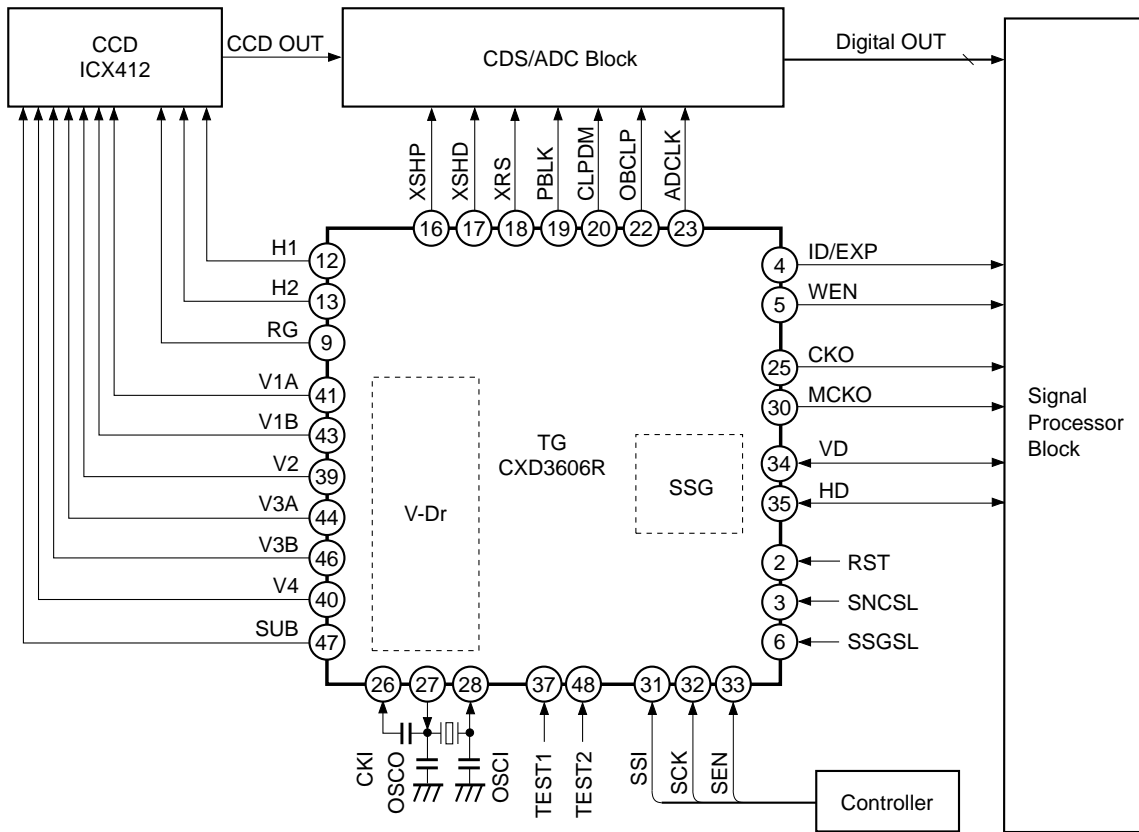

Application circuits shown are typical examples illustrating the operation of the devices. Sony cannot assume responsibility for any problems arising out of the use of these circuits or for any infringement of third party patent and other right due to same.

Notes for Power-on

Of the three -7.5V, +15.0V, +3.3V power supplies, be sure to start up the -7.5V and +15.0V power supplies in the following order to prevent the SUB pin of the CCD image sensor from going to negative potential.

