

# 520 series

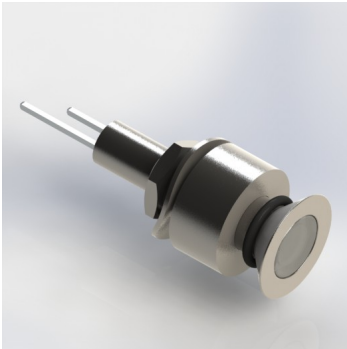

## features



- Ø6.1mm mounting
- Robust stainless steel housing
- Counter sunk mounting for flush styling
- Sealed to IP67, vandal resistant
- Sunlight readable LEDs with a colour diffused lens
- Internal reverse protection diode fitted as standard in all voltage models
- Pack Quantity = 10 Pieces

## specifications

Typical characteristics (Ta = 25°C)

Part Number	Colour	Voltage Vac/dc	Current DC (mA)	Luminous Intensity (mcd)	Wave Length (nm)	Operating Temp. (°C)	Storage Temp. (°C)	De-rating Graphs
520-301-21	Red	12 Vdc	20	39	660	-40 - +85	-40 - +85	A
520-325-21	Yellow	12 Vdc	20	87	590	-40 - +100	-40 - +120	Y
520-324-21	Green	12 Vdc	20	576	523	-30 - +85	-40 - +100	R
520-934-21	Blue	12 Vdc	20	128	468	-30 - +85	-40 - +100	R
520-998-21	White	12 Vdc	20	414	* See below	-30 - +85	-40 - +100	H
520-301-23	Red	28 Vdc	20	39	660	-40 - +85	-40 - +85	A
520-325-23	Yellow	28 Vdc	20	87	590	-40 - +100	-40 - +120	Y
520-324-23	Green	28 Vdc	20	576	523	-30 - +85	-40 - +100	R
520-934-23	Blue	28 Vdc	20	128	468	-30 - +85	-40 - +100	R
520-998-23	White	28 Vdc	20	414	* See below	-30 - +85	-40 - +100	H

998F	*Typical emission colour White			
x	0.287	0.283	0.330	0.330
y	0.295	0.305	0.360	0.339

- Intensities (lv) and colour shades of white (x, y co-ordinates) may vary between LEDs within a batch
- Products must be de-rated according to the de-rating information. Each de-rating graph refers to specific LEDs. Please refer to graphs on page 3.
- Luminous intensity is measured at 20mA on a discrete LED unless otherwise stated.

## to order

**to order please contact us on: t: +44 (0)1229 582 430**  
**f: +44 (0)1229 585 155 e: sales@marl.co.uk w: www.leds.co.uk**

© marl international limited technical documentation has been designed by marl international limited for the intention of providing information, which must not be copied or released to a third party without prior written consent from marl international limited. the information provided does not constitute part of any order or contract and should not be regarded as a representation relating to either products or service. no responsibility can be assumed for inaccuracies or printing errors. marl international limited reserve the right to alter without notice the specification or any conditions of supply for product or service.



# 520 series



## technical data

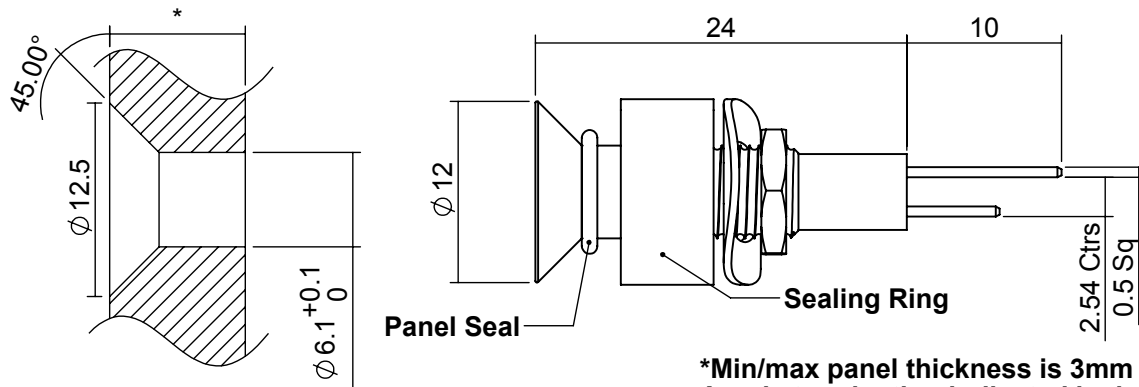

\*Min/max panel thickness is 3mm / 6.5mm.  
Anode termination indicated by long pin.  
Mounting hole to be clean and burr free.

Dimensions in mm (typical)  
Not to scale

## housing material

## push on connectors

<b>Body</b>	Stainless Steel Grade 303
<b>Nut</b>	Stainless Steel Grade 303
<b>Panel Seal</b>	Nitrile
<b>Termination</b>	Phosphor bronze with tin on nickel finish
<b>Lens</b>	Polycarbonate
<b>Encapsulation</b>	PC5430 Resin
<b>Lock Washer</b>	Stainless Steel
<b>Header</b>	-

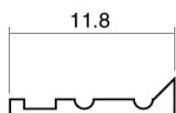

909-000-00 is gold plated, 910-000-00 is tin plated - for use with 520 series lamps.  
Dimensions in mm (typical). Not to scale.

## technical characteristics

Series	Max. Power Dissipation	Max. Reverse Voltage	Panel Cutout	Nut Mounting Torque	Min. Mounting Centres	Max. Panel Thickness
520	500	1000 <sup>^</sup>	6.1	0.65	15.0	3.0 - 6.5
units	mW	Vdc	mm	Nm	mm	mm

\* = Current version

<sup>^</sup> = Voltage version

## optional flying lead terminators

Order Code Suffix	Supply Voltage	Wire Colour	Wire Length	No/Diameter of Conductor	Diameter Insulation	Comments
15	DC products	Red-anode/ Black-cathode	150mm	19/0.15mm	1.2mm	Customised lengths available
15	AC products	Brown-live/ Blue-neutral	150mm			
19	DC products	Red-anode/ Black-cathode	1000mm			
19	AC products	Brown-live/ Blue-neutral	1000mm			

## to order

**to order please contact us on: t: +44 (0)1229 582 430 f: +44 (0)1229 585 155**  
**e: sales@marl.co.uk w: www.leds.co.uk**

© marl international limited technical documentation has been designed by marl international limited for the intention of providing information, which must not be copied or released to a third party without prior written consent from marl international limited. the information provided does not constitute part of any order or contract and should not be regarded as a representation relating to either products or service. no responsibility can be assumed for inaccuracies or printing errors. marl international limited reserve the right to alter without notice the specification or any conditions of supply for product or service.



# 520 series



## de-rating information

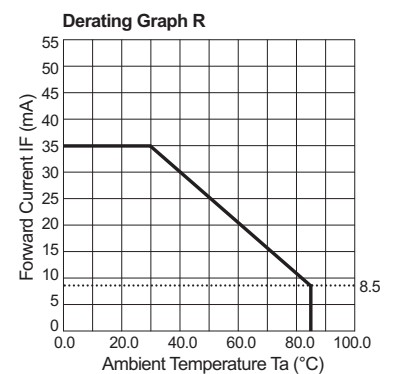
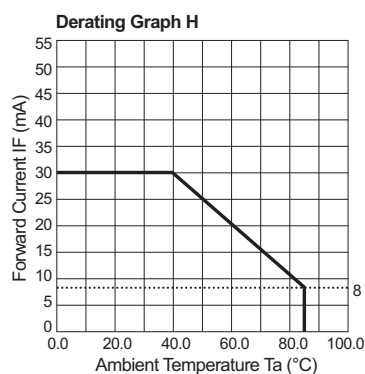
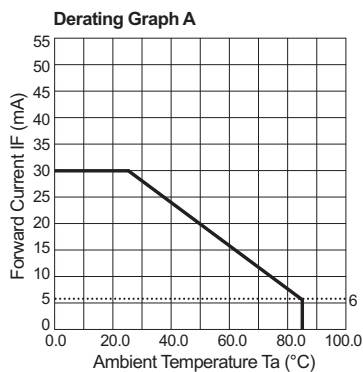

## also available

Part numbers also available in the 520 series:

Part Number	Colour	Voltage Vopr
520-301-04	Red	20 mA dc
520-301-20	Red	5/6 Vdc
520-301-22	Red	24 Vdc
520-301-23-15	Red	28 Vdc
520-324-04	Green	20 mA dc
520-324-21-15	Green	12 Vdc
520-324-21-50	Green	12 Vdc
520-324-22	Green	24 Vdc
520-325-22	Yellow	24 Vdc
520-330-04-50	Red/Green	20 mA dc
520-330-21	Red/Green	12 Vdc
520-330-22	Red/Green	24 Vdc
520-934-04	Blue	20 mA dc
520-934-22-15	Blue	24 Vdc
520-998-23-15	White	28 Vdc
520-998-23-19	White	28 Vdc
520-998-23-50	White	28 Vdc

The products listed here illustrate all of the options available to order. These products may have custom modifications that alter their operation beyond the generic information contained within this datasheet. Please contact sales for further information.

RP = Reverse Polarity

## to order

to order please contact us on: t: +44 (0)1229 582 430 f: +44 (0)1229 585 155  
e: [sales@marl.co.uk](mailto:sales@marl.co.uk) w: [www.leds.co.uk](http://www.leds.co.uk)

© marl international limited technical documentation has been designed by marl international limited for the intention of providing information, which must not be copied or released to a third party without prior written consent from marl international limited. the information provided does not constitute part of any order or contract and should not be regarded as a representation relating to either products or service. no responsibility can be assumed for inaccuracies or printing errors. marl international limited reserve the right to alter without notice the specification or any conditions of supply for product or service.



# 520 series



## de-rating information continued

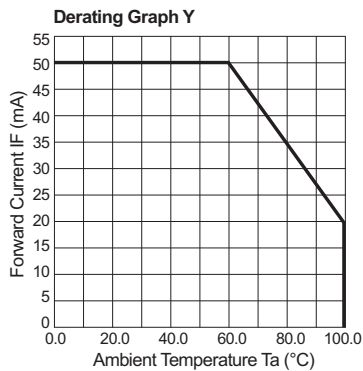

## to order

**to order please contact us on: t: +44 (0)1229 582 430 f: +44 (0)1229 585 155**  
**e: [sales@marl.co.uk](mailto:sales@marl.co.uk) w: [www.leds.co.uk](http://www.leds.co.uk)**

© marl international limited technical documentation has been designed by marl international limited for the intention of providing information, which must not be copied or released to a third party without prior written consent from marl international limited. the information provided does not constitute part of any order or contract and should not be regarded as a representation relating to either products or service. no responsibility can be assumed for inaccuracies or printing errors. marl international limited reserve the right to alter without notice the specification or any conditions of supply for product or service.



# 520 series



## design considerations

### Electro-Static Discharge (ESD)

Build up of electro-static discharge occurs in many situations involving people moving and handling products. The range of possible situations is very diverse but voltage levels as high as several thousand volts can and do arise in many individual situations. When an operator charged up to these levels handles a static sensitive device, there is a very probable likelihood that the device will be irreversibly damaged. It is essential that precautions are taken at all stages during manufacture and assembly of these products. Although LEDs were never considered to be static sensitive devices, changes in manufacturing technology and materials used to produce higher intensity products over a large range of the wavelength spectrum have changed this. Marl has an approved system of ESD control from goods in, through production and into final packing and despatch. Marl recommend all users of LED based products follow the guidelines of BS 100015.

### Power De-Rating

The forward voltage/ current value of an LED is dependant upon the ambient temperature of the environment in which it is operated. Therefore, care must be taken to operate the LED at the correct voltage/ current values, depending upon the ambient temperature. Consequently, a recommendation regarding operating voltages and currents is given in order to address these temperature effects. This recommendation is termed 'de-rating'. It is usual for forward voltages and currents to be specified for ambient temperature of 25°C. However, because the values of these qualities vary with temperature, please refer to the de-rating graphs for correct operation. Marl accept no liability for any product that is operated higher than the stated voltage.

## to order

**to order please contact us on: t: +44 (0)1229 582 430 f: +44 (0)1229 585 155  
e: [sales@marl.co.uk](mailto:sales@marl.co.uk) w: [www.leds.co.uk](http://www.leds.co.uk)**

© marl international limited technical documentation has been designed by marl international limited for the intention of providing information, which must not be copied or released to a third party without prior written consent from marl international limited. the information provided does not constitute part of any order or contract and should not be regarded as a representation relating to either products or service. no responsibility can be assumed for inaccuracies or printing errors. marl international limited reserve the right to alter without notice the specification or any conditions of supply for product or service.

