

Preliminary
Spec.

MH64S72QJA -7,-8

4,831,838,208-BIT (67,108,864-WORD BY 72-BIT) Synchronous DYNAMIC RAM

PRELIMINARY

Some of contents are subject to change without notice.

DESCRIPTION

The MH64S72QJA is 67108864 - word x 72-bit Synchronous DRAM stacked structural module. This consist of thirty-six industry standard 32M x 4 Synchronous DRAMs in TSOP.

The stacked structure of TSOP on a card edge dual in-line package provides any application where high densities and large of quantities memory are required.

This is a socket-type memory module ,suitable for easy interchange or addition of module.

FEATURES

Type name	Max. Frequency	CLK Access Time [latch mode] (CL = 4)	CLK Access Time [buffer mode] (CL = 3)
MH64S72QJA-7	100MHz	6ns	6ns
MH64S72QJA-8	100MHz	6ns	6ns

- Utilizes industry standard 32M X 4 Synchronous DRAMs in TSOP package , industry standard Resister in TSSOP package , and industrystandard PLL in TSSOP package.
- Single 3.3V +/- 0.3V power supply
- LVTTTL Interface
- 4096 refresh cycles every 64ms

APPLICATION

Main memory unit for computers, Microcomputer memory.

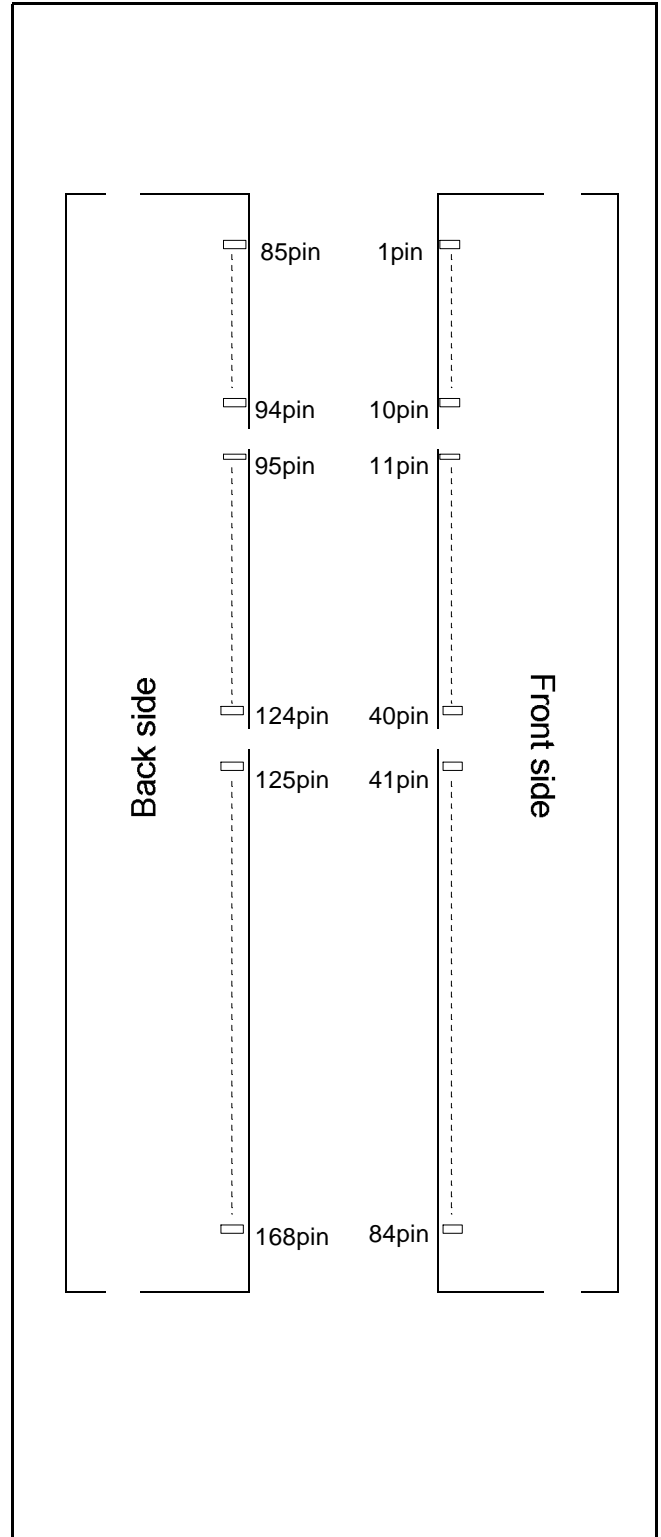

Preliminary
Spec.

MITSUBISHI LSIs

MH64S72QJA -7,-8

4,831,838,208-BIT (67,108,864-WORD BY 72-BIT) Synchronous DYNAMIC RAM

PIN NO.	PIN NAME	PIN NO.	PIN NAME	PIN NO.	PIN NAME	PIN NO.	PIN NAME
1	VSS	43	VSS	85	VSS	127	VSS
2	DQ0	44	NC	86	DQ32	128	CKE0
3	DQ1	45	/S2	87	DQ33	129	/S3
4	DQ2	46	DQMB2	88	DQ34	130	DQMB6
5	DQ3	47	DQMB3	89	DQ35	131	DQMB7
6	VDD	48	NC	90	VDD	132	NC
7	DQ4	49	VDD	91	DQ36	133	VDD
8	DQ5	50	NC	92	DQ37	134	NC
9	DQ6	51	NC	93	DQ38	135	NC
10	DQ7	52	CB2	94	DQ39	136	CB6
11	DQ8	53	CB3	95	DQ40	137	CB7
12	VSS	54	VSS	96	VSS	138	VSS
13	DQ9	55	DQ16	97	DQ41	139	DQ48
14	DQ10	56	DQ17	98	DQ42	140	DQ49
15	DQ11	57	DQ18	99	DQ43	141	DQ50
16	DQ12	58	DQ19	100	DQ44	142	DQ51
17	DQ13	59	VDD	101	DQ45	143	VDD
18	VDD	60	DQ20	102	VDD	144	DQ52
19	DQ14	61	NC	103	DQ46	145	NC
20	DQ15	62	NC	104	DQ47	146	NC
21	CB0	63	NC	105	CB4	147	REGE
22	CB1	64	VSS	106	CB5	148	VSS
23	VSS	65	DQ21	107	VSS	149	DQ53
24	NC	66	DQ22	108	NC	150	DQ54
25	NC	67	DQ23	109	NC	151	DQ55
26	VDD	68	VSS	110	VDD	152	VSS
27	/WE	69	DQ24	111	/CAS	153	DQ56
28	DQMB0	70	DQ25	112	DQMB4	154	DQ57
29	DQMB1	71	DQ26	113	DQMB5	155	DQ58
30	/S0	72	DQ27	114	/S1	156	DQ59
31	NC	73	VDD	115	/RAS	157	VDD
32	VSS	74	DQ28	116	VSS	158	DQ60
33	A0	75	DQ29	117	A1	159	DQ61
34	A2	76	DQ30	118	A3	160	DQ62
35	A4	77	DQ31	119	A5	161	DQ63
36	A6	78	VSS	120	A7	162	VSS
37	A8	79	CK2	121	A9	163	CK3
38	A10	80	NC	122	BA0	164	NC
39	BA1	81	WP	123	A11	165	SA0
40	VDD	82	SDA	124	VDD	166	SA1
41	VDD	83	SCL	125	CK1	167	SA2
42	CK0	84	VDD	126	NC	168	VDD

NC = No Connection

Preliminary
Spec.

MITSUBISHI LSIs

MH64S72QJA -7,-8

4,831,838,208-BIT (67,108,864-WORD BY 72-BIT) Synchronous DYNAMIC RAM

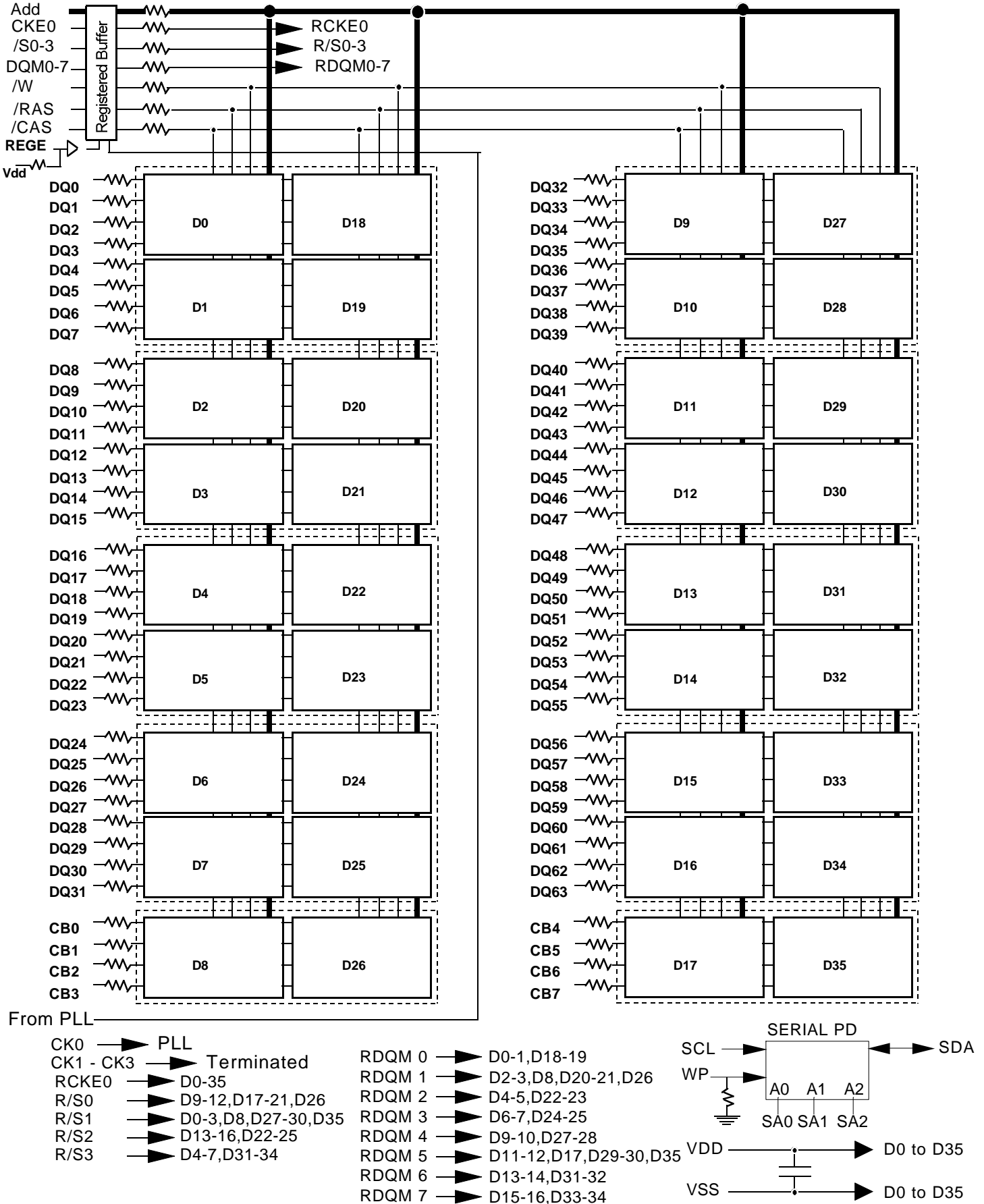

Preliminary
Spec.

MH64S72QJA -7,-8

4,831,838,208-BIT (67,108,864-WORD BY 72-BIT) Synchronous DYNAMIC RAM

Serial Presence Detect Table I

Byte	Function described	SPD entry data	SPD DATA(hex)	
0	Defines # bytes written into serial memory at module mfg r	128	80	
1	Total # bytes of SPD memory device	256 Bytes	08	
2	Fundamental memory type	SDRAM	04	
3	# Row Addresses on this assembly	A0-A11	0C	
4	# Column Addresses on this assembly	A0-A10	0B	
5	# Module Banks on this assembly	2BANK	02	
6	Data Width of this assembly...	x72	48	
7	... Data Width continuation	0	00	
8	Voltage interface standard of this assembly	LVTTL	01	
9	SDRAM Cyletime at Max. Supported CAS Latency (CL). Cycle time for CL=3	10ns	A0	
10	SDRAM Access from Clock tAC for CL=3	6ns	60	
11	DIMM Configuration type (Non-parity,Parity,ECC)	ECC	02	
12	Refresh Rate/Type	self refresh(15.625uS)	80	
13	SDRAM width,Primary DRAM	x4	04	
14	Error Checking SDRAM data width	x4	04	
15	Mnimum Clock Delay,Back to Back Random Column Addresses	1	01	
16	Burst Lengths Supported	1/2/4/8/Full page	8F	
17	# Banks on Each SDRAM device	4bank	04	
18	CAS# Latency	2/3	06	
19	CS# Latency	0	01	
20	Write Latency	0	01	
21	SDRAM Module Attributes	buffered,registered	1F	
22	SDRAM Device Attributes:General	Precharge All,Auto precharge Write 1/Read Burst	0E	
23	SDRAM Cycle time(2nd highest CAS latency) Cycle time for CL=2	-7	10ns	A0
		-8	13ns	D0
24	SDRAM Access form Clock(2nd highest CAS latency) tAC for CL=2	-7	6ns	60
		-8	7ns	70
25	SDRAM Cycle time(3rd highest CAS latency)	N/A	00	
26	SDRAM Access form Clock(3rd highest CAS latency)	N/A	00	
27	Precharge to Active Minimum	20ns	14	
28	Row Active to Row Active Min.	20ns	14	
29	RAS to CAS Delay Min	20ns	14	
30	Active to Precharge Min	50ns	32	

Preliminary
Spec.

MH64S72QJA -7,-8

4,831,838,208-BIT (67,108,864-WORD BY 72-BIT) Synchronous DYNAMIC RAM

Serial Presence Detect Table II

31	Density of each bank on module	256MByte	40
32	Command and Address signal input setup time	2ns	20
33	Command and Address signal input hold time	1ns	10
34	Data signal input setup time	2ns	20
35	Data signal input hold time	1ns	10
36-61	Superset Information (may be used in future)	option	00
62	SPD Revision	rev 1.2A	12
63	Checksum for bytes 0-62	Check sum for -7	61
		Check sum for -8	A1
64-71	Manufactures Jedec ID code per JEP-108E	MITSUBISHI	1CFFFFFFFFFFFFFF
72	Manufacturing location	Miyoshi,Japan	01
		Tajima,Japan	02
		NC,USA	03
		Germany	04
73-90	Manufactures Part Number	MH64S72QJA-7	4D483634533732514A412D372020202020
		MH64S72QJA-8	4D483634533732514A412D382020202020
91-92	Revision Code	PCB revision	rrrr
93-94	Manufacturing date	year/week code	yyww
95-98	Assembly Serial Number	serial number	ssssssss
99-125	Manufacture Specific Data	option	00
126	Intel specification frequency	100MHz	64
127	Intel specification CAS# Latency support	CL=2/3,AP,CK0	8F
128+	Unused storage locations	open	00

MH64S72QJA -7,-8

4,831,838,208-BIT (67,108,864-WORD BY 72-BIT) Synchronous DYNAMIC RAM

PIN FUNCTION

CK0	Input	Master Clock:All other inputs are referenced to the rising edge of CK
CKE0	Input	Clock Enable:CKE controls internal clock.When CKE is low,internal clock for the following cycle is ceased. CKE is also used to select auto / self refresh. After self refresh mode is started, CKE E becomes asynchronous input.Self refresh is maintained as long as CKE is low.
/S0 - 3	Input	Chip Select: When /S is high,any command means No Operation.
/RAS,/CAS,/W	Input	Combination of /RAS,/CAS,/W defines basic commands.
A0-11	Input	A0-11 specify the Row/Column Address in conjunction with BA.The Row Address is specified by A0-11.The Column Address is specified by A0-10.A10 is also used to indicate precharge option.When A10 is high at a read / write command, an auto precharge is performed. When A10 is high at a precharge command, both banks are precharged.
BA0-1	Input	Bank Address:BA0,1 is not simply BA.BA0,1 specifies the bank to which a command is applied.BA must be set with ACT,PRE,READ,WRITE commands
DQ0-63 CB0-7	Input/Output	Data In and Data out are referenced to the rising edge of CK
DQM0-7	Input	Din Mask/Output Disable:When DQMB is high in burst write.Din for the current cycle is masked.When DQMB is high in burst read,Dout is disabled at the next but one cycle.
Vdd,Vss	Power Supply	Power Supply for the memory mounted module.
REGE	Output	Register enable:When REGE is low,All control signals and address are buffered. (Buffer mode) When REGE is high,All control and address are latched. (Latch mode)

MH64S72QJA -7,-8

4,831,838,208-BIT (67,108,864-WORD BY 72-BIT) Synchronous DYNAMIC RAM

BASIC FUNCTIONS

The MH64S72QJA provides basic functions, bank(row) activate, burst read / write, bank(row) precharge, and auto / self refresh.

Each command is defined by control signals of /RAS, /CAS and /WE at CK rising edge. In addition to 3 signals, /S, CKE and A10 are used as chip select, refresh option, and precharge option, respectively.

To know the detailed definition of commands please see the command truth table.

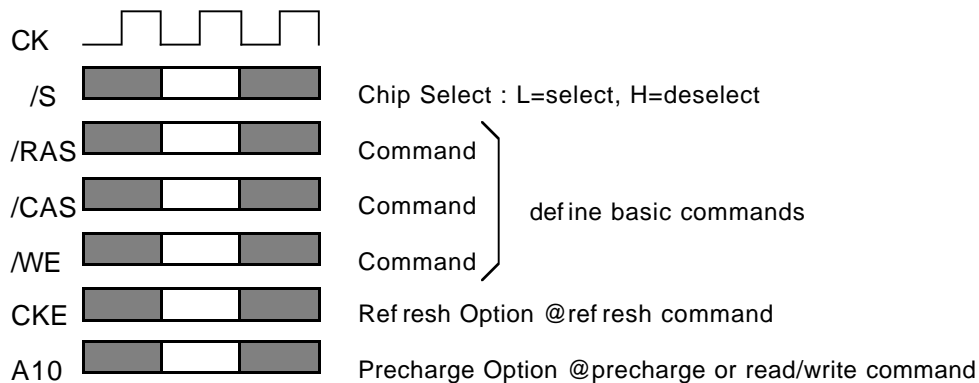

Activate(ACT) [/RAS =L, /CAS = /WE =H]

ACT command activates a row in an idle bank indicated by BA.

Read(READ) [/RAS =H, /CAS =L, /WE =H]

READ command starts burst read from the active bank indicated by BA. First output data appears after /CAS latency. When A10 =H at this command, the bank is deactivated after the burst read(auto-precharge, **READA**).

Write(WRITE) [/RAS =H, /CAS = /WE =L]

WRITE command starts burst write to the active bank indicated by BA. Total data length to be written is set by burst length. When A10 =H at this command, the bank is deactivated after the burst write(auto-precharge, **WRITEA**).

Precharge(PRE) [/RAS =L, /CAS =H, /WE =L]

PRE command deactivates the active bank indicated by BA. This command also terminates burst read / write operation. When A10 =H at this command, both banks are deactivated(precharge all, **PREA**).

Auto-Refresh(REF) [/RAS =/CAS =L, /WE =CKE =H]

REF command starts auto-refresh cycle. Refresh address including bank address are generated internally. After this command, the banks are precharged automatically.

MH64S72QJA -7,-8

4,831,838,208-BIT (67,108,864-WORD BY 72-BIT) Synchronous DYNAMIC RAM

COMMAND TRUTH TABLE

COMMAND	MNEMONIC	CKE _{n-1}	CKE _n	/S	/RAS	/CAS	/WE	BA0,1	A11	A10	A0-9
Deselect	DESEL	H	X	H	X	X	X	X	X	X	X
No Operation	NOP	H	X	L	H	H	H	X	X	X	X
Row Address Entry & Bank Activate	ACT	H	X	L	L	H	H	V	V	V	V
Single Bank Precharge	PRE	H	X	L	L	H	L	V	X	L	X
Precharge All Bank	PREA	H	X	L	L	H	L	X	X	H	X
Column Address Entry & Write	WRITE	H	X	L	H	L	L	V	V	L	V
Column Address Entry & Write with Auto-Precharge	WRITEA	H	X	L	H	L	L	V	V	H	V
Column Address Entry & Read	READ	H	X	L	H	L	H	V	V	L	V
Column Address Entry & Read with Auto Precharge	READA	H	X	L	H	L	H	V	V	H	V
Auto-Refresh	REFA	H	H	L	L	L	H	X	X	X	X
Self-Refresh Entry	REFS	H	L	L	L	L	H	X	X	X	X
Self-Refresh Exit	REFSX	L	H	H	X	X	X	X	X	X	X
		L	H	L	H	H	H	X	X	X	X
Mode Register Set	MRS	H	X	L	L	L	L	L	L	L	V*1

H = High Level, L = Low Level, V = Valid, X = Don't Care, n = CK cycle number

NOTE:

1.A7-9 = 0, A0-6 = Mode Address

Preliminary
Spec.

MH64S72QJA -7,-8

4,831,838,208-BIT (67,108,864-WORD BY 72-BIT) Synchronous DYNAMIC RAM

FUNCTION TRUTH TABLE

Current State	/S	/RAS	/CAS	/WE	Address	Command	Action
IDLE	H	X	X	X	X	DESEL	NOP
	L	H	H	H	X	NOP	NOP
	L	H	H	L	BA	TBST	ILLEGAL*2
	L	H	L	X	BA,CA,A10	READ/WRITE	ILLEGAL*2
	L	L	H	H	BA,RA	ACT	Bank Active,Latch RA
	L	L	H	L	BA,A10	PRE/PREA	NOP*4
	L	L	L	H	X	REFA	Auto-Refresh*5
	L	L	L	L	Op-Code, Mode-Add	MRS	Mode Register Set*5
ROW ACTIVE	H	X	X	X	X	DESEL	NOP
	L	H	H	H	X	NOP	NOP
	L	H	H	L	BA	TBST	NOP
	L	H	L	H	BA,CA,A10	READ/READA	Begin Read,Latch CA, Determine Auto-Precharge
	L	H	L	L	BA,CA,A10	WRITE/ WRITEA	Begin Write,Latch CA, Determine Auto-Precharge
	L	L	H	H	BA,RA	ACT	Bank Active/ILLEGAL*2
	L	L	H	L	BA,A10	PRE/PREA	Precharge/Precharge All
	L	L	L	H	X	REFA	ILLEGAL
	L	L	L	L	Op-Code, Mode-Add	MRS	ILLEGAL
READ	H	X	X	X	X	DESEL	NOP(Continue Burst to END)
	L	H	H	H	X	NOP	NOP(Continue Burst to END)
	L	H	H	L	BA	TBST	Terminate Burst
	L	H	L	H	BA,CA,A10	READ/READA	Terminate Burst,Latch CA, Begin New Read,Determine Auto-Precharge*3
	L	H	L	L	BA,CA,A10	WRITE/WRITEA	Terminate Burst,Latch CA, Begin Write,Determine Auto- Precharge*3
	L	L	H	H	BA,RA	ACT	Bank Active/ILLEGAL*2
	L	L	H	L	BA,A10	PRE/PREA	Terminate Burst,Precharge
	L	L	L	H	X	REFA	ILLEGAL
	L	L	L	L	Op-Code, Mode-Add	MRS	ILLEGAL

MH64S72QJA -7,-8

4,831,838,208-BIT (67,108,864-WORD BY 72-BIT) Synchronous DYNAMIC RAM

FUNCTION TRUTH TABLE(continued)

Current State	/S	/RAS	/CAS	/WE	Address	Command	Action
WRITE	H	X	X	X	X	DESEL	NOP(Continue Burst to END)
	L	H	H	H	X	NOP	NOP(Continue Burst to END)
	L	H	H	L	BA	TBST	Terminate Burst
	L	H	L	H	BA,CA,A10	READ/READA	Terminate Burst,Latch CA, Begin Read,Determine Auto-Precharge*3
	L	H	L	L	BA,CA,A10	WRITE/ WRITEA	Terminate Burst,Latch CA, Begin Write,Determine Auto-Precharge*3
	L	L	H	H	BA,RA	ACT	Bank Active/ILLEGAL*2
	L	L	H	L	BA,A10	PRE/PREA	Terminate Burst,Precharge
	L	L	L	H	X	REFA	ILLEGAL
	L	L	L	L	Op-Code, Mode-Add	MRS	ILLEGAL
READ with AUTO PRECHARGE	H	X	X	X	X	DESEL	NOP(Continue Burst to END)
	L	H	H	H	X	NOP	NOP(Continue Burst to END)
	L	H	H	L	BA	TBST	ILLEGAL
	L	H	L	H	BA,CA,A10	READ/READA	ILLEGAL
	L	H	L	L	BA,CA,A10	WRITE/ WRITEA	ILLEGAL
	L	L	H	H	BA,RA	ACT	Bank Active/ILLEGAL*2
	L	L	H	L	BA,A10	PRE/PREA	ILLEGAL*2
	L	L	L	H	X	REFA	ILLEGAL
	L	L	L	L	Op-Code, Mode-Add	MRS	ILLEGAL
WRITE with AUTO PRECHARGE	H	X	X	X	X	DESEL	NOP(Continue Burst to END)
	L	H	H	H	X	NOP	NOP(Continue Burst to END)
	L	H	H	L	BA	TBST	ILLEGAL
	L	H	L	H	BA,CA,A10	READ/READA	ILLEGAL
	L	H	L	L	BA,CA,A10	WRITE/ WRITEA	ILLEGAL
	L	L	H	H	BA,RA	ACT	Bank Active/ILLEGAL*2
	L	L	H	L	BA,A10	PRE/PREA	ILLEGAL*2
	L	L	L	H	X	REFA	ILLEGAL
	L	L	L	L	Op-Code, Mode-Add	MRS	ILLEGAL

MH64S72QJA -7,-8

4,831,838,208-BIT (67,108,864-WORD BY 72-BIT) Synchronous DYNAMIC RAM

FUNCTION TRUTH TABLE(continued)

Current State	/S	/RAS	/CAS	/WE	Address	Command	Action
PRE - CHARGING	H	X	X	X	X	DESEL	NOP(Idle after tRP)
	L	H	H	H	X	NOP	NOP(Idle after tRP)
	L	H	H	L	BA	TBST	ILLEGAL*2
	L	H	L	X	BA,CA,A10	READ/WRITE	ILLEGAL*2
	L	L	H	H	BA,RA	ACT	ILLEGAL*2
	L	L	H	L	BA,A10	PRE/PREA	NOP*4(Idle after tRP)
	L	L	L	H	X	REFA	ILLEGAL
	L	L	L	L	Op-Code, Mode-Add	MRS	ILLEGAL
ROW ACTIVATING	H	X	X	X	X	DESEL	NOP(Row Active after tRCD)
	L	H	H	H	X	NOP	NOP(Row Active after tRCD)
	L	H	H	L	BA	TBST	ILLEGAL*2
	L	H	L	X	BA,CA,A10	READ/WRITE	ILLEGAL*2
	L	L	H	H	BA,RA	ACT	ILLEGAL*2
	L	L	H	L	BA,A10	PRE/PREA	ILLEGAL*2
	L	L	L	H	X	REFA	ILLEGAL
	L	L	L	L	Op-Code, Mode-Add	MRS	ILLEGAL
WRITE RE- COVERING	H	X	X	X	X	DESEL	NOP
	L	H	H	H	X	NOP	NOP
	L	H	H	L	BA	TBST	ILLEGAL*2
	L	H	L	X	BA,CA,A10	READ/WRITE	ILLEGAL*2
	L	L	H	H	BA,RA	ACT	ILLEGAL*2
	L	L	H	L	BA,A10	PRE/PREA	ILLEGAL*2
	L	L	L	H	X	REFA	ILLEGAL
	L	L	L	L	Op-Code, Mode-Add	MRS	ILLEGAL

MH64S72QJA -7,-8

4,831,838,208-BIT (67,108,864-WORD BY 72-BIT) Synchronous DYNAMIC RAM

FUNCTION TRUTH TABLE(continued)

Current State	/S	/RAS	/CAS	/WE	Address	Command	Action
RE-FRESHING	H	X	X	X	X	DESEL	NOP(Idle after tRC)
	L	H	H	H	X	NOP	NOP(Idle after tRC)
	L	H	H	L	BA	TBST	ILLEGAL
	L	H	L	X	BA,CA,A10	READ/WRITE	ILLEGAL
	L	L	H	H	BA,RA	ACT	ILLEGAL
	L	L	H	L	BA,A10	PRE/PREA	ILLEGAL
	L	L	L	H	X	REFA	ILLEGAL
MODE REGISTER SETTING	L	L	L	L	Op-Code, Mode-Add	MRS	ILLEGAL
	H	X	X	X	X	DESEL	NOP(Idle after tRSC)
	L	H	H	H	X	NOP	NOP(Idle after tRSC)
	L	H	H	L	BA	TBST	ILLEGAL
	L	H	L	X	BA,CA,A10	READ/WRITE	ILLEGAL
	L	L	H	H	BA,RA	ACT	ILLEGAL
	L	L	H	L	BA,A10	PRE/PREA	ILLEGAL
L	L	L	H	X	REFA	ILLEGAL	
L	L	L	L	Op-Code, Mode-Add	MRS	ILLEGAL	

ABBREVIATIONS:

H = High Level, L = Low Level, X = Don't Care

BA = Bank Address, RA = Row Address, CA = Column Address, NOP = No Operation

NOTES:

1. All entries assume that CKE was High during the preceding clock cycle and the current clock cycle.
2. ILLEGAL to bank in specified state; function may be legal in the bank indicated by BA, depending on the state of that bank.
3. Must satisfy bus contention, bus turn around, write recovery requirements.
4. NOP to bank precharging or in idle state. May precharge bank indicated by BA.
5. ILLEGAL if any bank is not idle.

ILLEGAL = Device operation and / or data-integrity are not guaranteed.

MH64S72QJA -7,-8

4,831,838,208-BIT (67,108,864-WORD BY 72-BIT) Synchronous DYNAMIC RAM

FUNCTION TRUTH TABLE for CKE

Current State	CKE _{n-1}	CKE _n	/S	/RAS	/CAS	/WE	Add	Action
SELF - REFRESH*1	H	X	X	X	X	X	X	INVALID
	L	H	H	X	X	X	X	Exit Self-Refresh(Idle after tRC)
	L	H	L	H	H	H	X	Exit Self-Refresh(Idle after tRC)
	L	H	L	H	H	L	X	ILLEGAL
	L	H	L	H	L	X	X	ILLEGAL
	L	H	L	L	X	X	X	ILLEGAL
	L	L	X	X	X	X	X	NOP(Maintain Self-Refresh)
POWER DOWN	H	X	X	X	X	X	X	INVALID
	L	H	X	X	X	X	X	Exit Power Down to Idle
	L	L	X	X	X	X	X	NOP(Maintain Self-Refresh)
ALL BANKS IDLE*2	H	H	X	X	X	X	X	Refer to Function Truth Table
	H	L	L	L	L	H	X	Enter Self-Refresh
	H	L	H	X	X	X	X	Enter Power Down
	H	L	L	H	H	H	X	Enter Power Down
	H	L	L	H	H	L	X	ILLEGAL
	H	L	L	H	L	X	X	ILLEGAL
	H	L	L	L	X	X	X	ILLEGAL
	L	X	X	X	X	X	X	Refer to Current State = Power Down
ANY STATE other than listed above	H	H	X	X	X	X	X	Refer to Function Truth Table
	H	L	X	X	X	X	X	Begin CK0 Suspend at Next Cycle*3
	L	H	X	X	X	X	X	Exit CK0 Suspend at Next Cycle*3
	L	L	X	X	X	X	X	Maintain CK0 Suspend

ABBREVIATIONS:

H = High Level, L = Low Level, X = Don't Care

NOTES:

1. CKE Low to High transition will re-enable CK and other inputs **asynchronously**. A minimum setup time must be satisfied before any command other than EXIT.
2. Power-Down and Self-Refresh can be entered only form the All banks idle State.
3. Must be legal command.

MH64S72QJA -7,-8

4,831,838,208-BIT (67,108,864-WORD BY 72-BIT) Synchronous DYNAMIC RAM

POWER ON SEQUENCE

Before starting normal operation, the following power on sequence is necessary to prevent a SDRAM from damaged or malfunctioning.

1. Apply power and start clock. Attempt to maintain CKE high, DQMB high and NOP condition at the inputs.
2. Maintain stable power, stable clock, and NOP input conditions for a minimum of 200µs.
3. Issue precharge commands for all banks. (PRE or PREA)
4. After all banks become idle state (after tRP), issue 8 or more auto-refresh commands.
5. Issue a mode register set command to initialize the mode register.

After these sequence, the SDRAM is idle state and ready for normal operation.

MODE REGISTER

Burst Length, Burst Type and /CAS Latency can be programmed by setting the mode register(MRS). The mode register stores these data until the next MRS command, which may be issue when both banks are in idle state. After tRSC from a MRS command, the SDRAM is ready for new command.

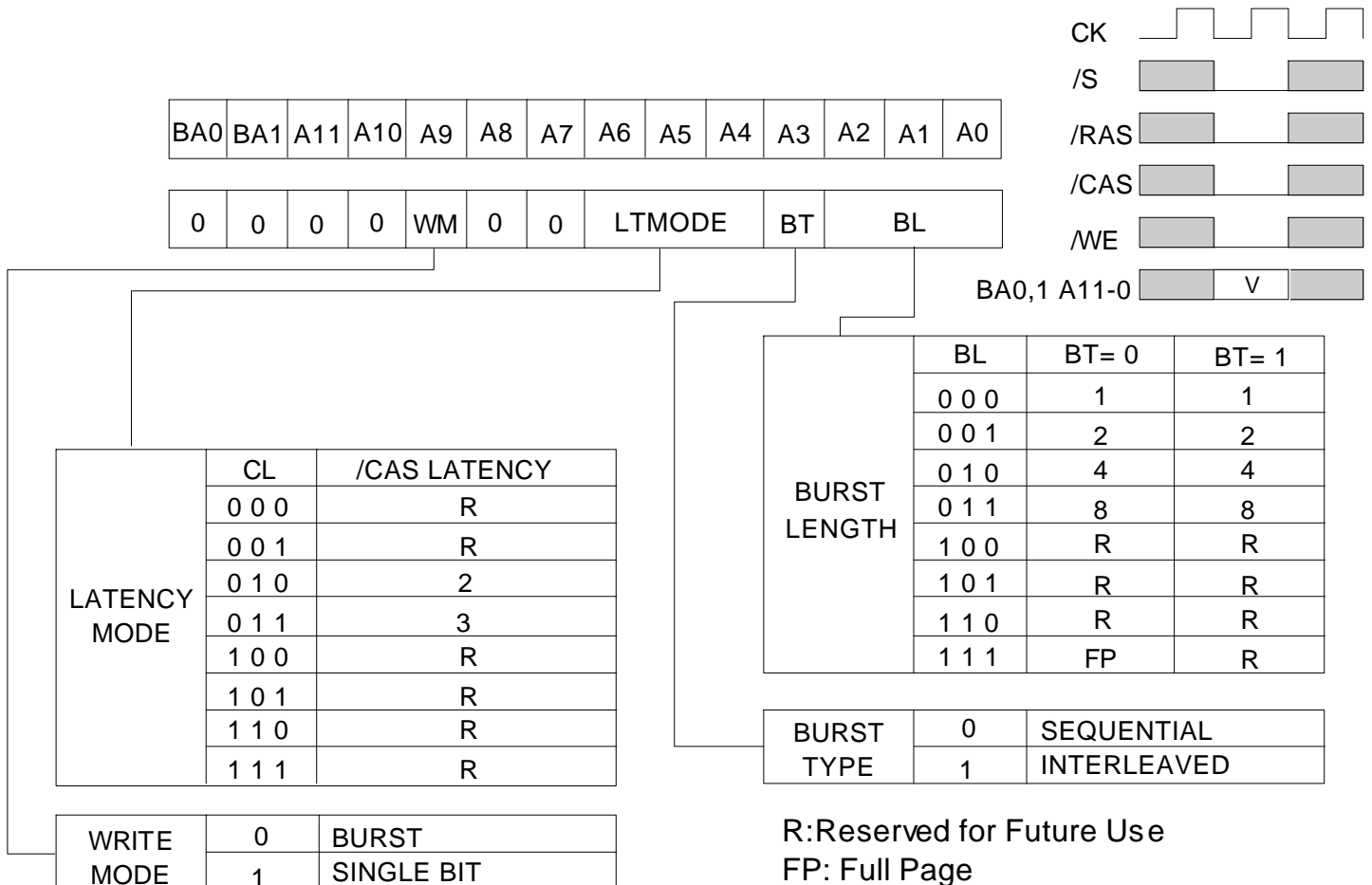

MH64S72QJA -7,-8

4,831,838,208-BIT (67,108,864-WORD BY 72-BIT) Synchronous DYNAMIC RAM

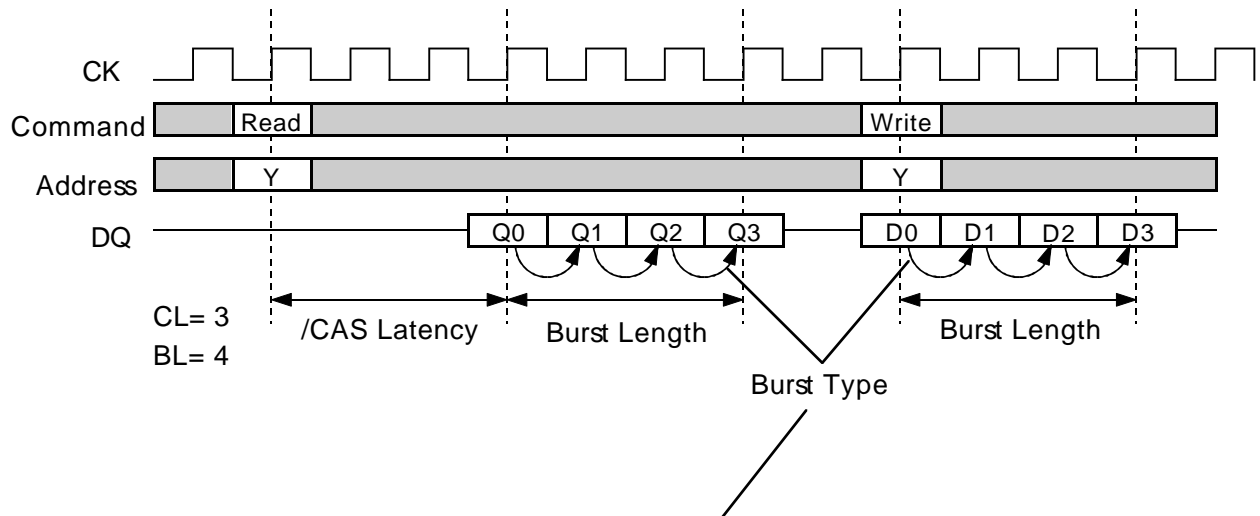

Initial Address			BL	Column Addressing															
A2	A1	A0		Sequential								Interleaved							
0	0	0	8	0	1	2	3	4	5	6	7	0	1	2	3	4	5	6	7
0	0	1		1	2	3	4	5	6	7	0	1	0	3	2	5	4	7	6
0	1	0		2	3	4	5	6	7	0	1	2	3	0	1	6	7	4	5
0	1	1		3	4	5	6	7	0	1	2	3	2	1	0	7	6	5	4
1	0	0		4	5	6	7	0	1	2	3	4	5	6	7	0	1	2	3
1	0	1		5	6	7	0	1	2	3	4	5	4	7	6	1	0	3	2
1	1	0		6	7	0	1	2	3	4	5	6	7	4	5	2	3	0	1
1	1	1		7	0	1	2	3	4	5	6	7	6	5	4	3	2	1	0
-	0	0	4	0	1	2	3					0	1	2	3				
-	0	1		1	2	3	0					1	0	3	2				
-	1	0		2	3	0	1					2	3	0	1				
-	1	1		3	0	1	2					3	2	1	0				
-	-	0	2	0	1					0	1								
-	-	1		1	0					1	0								

Preliminary
Spec.

MH64S72QJA -7,-8

4,831,838,208-BIT (67,108,864-WORD BY 72-BIT) Synchronous DYNAMIC RAM

ABSOLUTE MAXIMUM RATINGS

Symbol	Parameter	Condition	Ratings	Unit
Vdd	Supply Voltage	with respect to Vss	-0.5 ~ 4.6	V
VI	Input Voltage	with respect to Vss	-0.5 ~ 4.6	V
VO	Output Voltage	with respect to Vss	-0.5 ~ 4.6	V
IO	Output Current		50	mA
Pd	Power Dissipation	Ta=25°C	40	W
Topr	Operating Temperature		0 ~ 70	°C
Tstg	Storage Temperature		-45 ~ 100	°C

RECOMMENDED OPERATING CONDITION

(Ta=0 ~ 70°C, unless otherwise noted)

Symbol	Parameter	Limits			Unit
		Min.	Typ.	Max.	
Vdd	Supply Voltage	3.0	3.3	3.6	V
Vss	Supply Voltage	0	0	0	V
VIH	High-Level Input Voltage all inputs	2.0		Vdd+0.3	V
VIL	Low-Level Input Voltage all inputs	-0.3		0.8	V

CAPACITANCE

(Ta=0 ~ 70°C, Vdd = 3.3 +/- 0.3V, Vss = 0V, unless otherwise noted)

Symbol	Parameter	Test Condition	Limits(max.)	Unit
CI(A)	Input Capacitance, address pin	VI = Vss f=1MHz Vi=25mVrms	20	pF
CI(C)	Input Capacitance, control pin		20	pF
CI(K)	Input Capacitance, CK0 pin		14	pF
CI/O	Input Capacitance, I/O pin		22	pF

Preliminary
Spec.

MH64S72QJA -7,-8

4,831,838,208-BIT (67,108,864-WORD BY 72-BIT) Synchronous DYNAMIC RAM

AVERAGE SUPPLY CURRENT from Vdd

(Ta=0 ~70°C, Vdd = 3.3 ± 0.3V, Vss = 0V, unless otherwise noted)

Symbol	Parameter	Test Condition	Limits(max)		Unit
			-7	-8	
lcc1	operating current, single bank	tRC=min,tCLK=min, BL=1, CL=3 (Note1)	3059	3059	mA
lcc2N	precharge standby current in	tCLK=min,CKE=H,/CS > Vcc-0.2V,VIH > Vcc-0.2V,VIL < 0.2V (Note1)	1349	1349	mA
lcc2NS	Non Power down mode	CLK=L & CKE=H,/CS > Vcc-0.2V,VIH > Vcc-0.2V,VIL < 0.2V all input signals are fixed. (Note1)	333	333	mA
lcc2P	precharge standby current in	tCLK=min,CKE=L,/CS > Vcc-0.2V (Note1)	701	701	mA
lcc2PS	Power down mode	CLK=L,CKE=L,/CS > Vcc-0.2V (Note1)	82	82	mA
lcc3N	active standby current in Non	CKE=H,tCLK=min. (Note1)	1709	1709	mA
lcc3NS	Power down mode	CKE=H,CLK=L (Note1)	945	945	mA
lcc3P	active standby current in	CKE=L,tCLK=min. (Note1)	809	809	mA
lcc3PS	Power down mode	CKE=L,CLK=L (Note1)	225	225	mA
lcc4	burst current	tCLK=min, BL=4, CL=3, all banks active(discrete) (Note1)	3059	3059	mA
lcc5	auto-refresh current	tRC=min, tCLK=min (Note1)	4229	4229	mA
lcc6	self-refresh current	CKE <0.2V (Note1)	82	82	mA

Note)

1.lcc(max) is specified at the output open condition.

AC OPERATING CONDITIONS AND CHARACTERISTICS

(Ta=0 ~ 70°C, Vdd = 3.3 ± 0.3V, Vss = 0V, unless otherwise noted)

Symbol	Parameter	Test Condition	Limits		Unit
			Min.	Max.	
VOH(DC)	High-Level Output Voltage(DC)	IOH=-2mA	2.4		V
VOL(DC)	Low-Level Output Voltage(DC)	IOL=2mA		0.4	V
IOZ	Off-state Output Current	Q floating VO=0 ~ Vdd	-10	10	uA
li	Input Current	VIH=0 ~ Vdd+0.3V	-20	20	uA

Preliminary
Spec.

MH64S72QJA -7,-8

4,831,838,208-BIT (67,108,864-WORD BY 72-BIT) Synchronous DYNAMIC RAM

AC TIMING REQUIREMENTS

(Ta=0 ~ 70°C, Vdd = 3.3 +/- 0.3V, Vss = 0V, unless otherwise noted)

Input Pulse Levels: 0.8V to 2.0V

Input Timing Measurement Level: 1.4V

LATCH MODE

Symbol	Parameter	Limits				Unit	
		-7		-8			
		Min.	Max.	Min.	Max.		
tCLK	CK cycle time	CL=3	10		13		ns
		CL=4	10		10		ns
tCH	CK High pulse width	3		3		ns	
tCL	CK Low pulse width	3		3		ns	
tT	Transition time of CK	1	10	1	10	ns	
tIS	Input Setup time(all inputs)	2		2		ns	
tIH	Input Hold time(all inputs)	1		1		ns	
tRC	Row cycle time	70		70		ns	
tRCD	Row to Column Delay	20		20		ns	
tRAS	Row Active time	50	100k	50	100k	ns	
tRP	Row Precharge time	20		20		ns	
tWR	Write Recovery time	20		20		ns	
tRRD	Act to Act Deley time	20		20		ns	
tCCD	Col to Col Delay time	10		10		ns	
tRSC	Mode Register Set Cycle time	20		20		ns	
tSRX	Self Refresh Exit time	10		10		ns	
tREF	Refresh Interval time		64		64	ms	

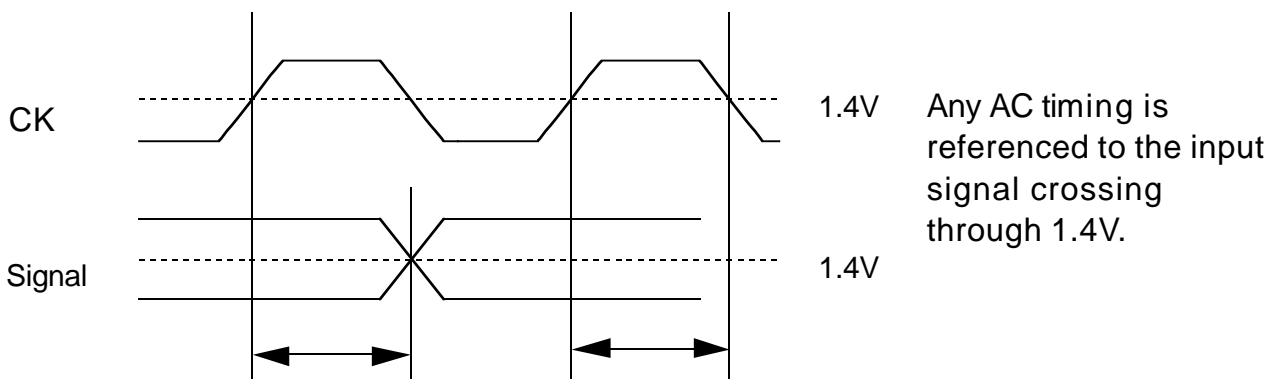

Preliminary
Spec.

MH64S72QJA -7,-8

4,831,838,208-BIT (67,108,864-WORD BY 72-BIT) Synchronous DYNAMIC RAM

BUFFER MODE

Symbol	Parameter	Limits				Unit	
		-7		-8			
		Min.	Max.	Min.	Max.		
tCLK	CK cycle time	CL=2	10		13		ns
		CL=3	10		10		ns
tCH	CK High pulse width	3		3		ns	
tCL	CK Low pulse width	3		3		ns	
tT	Transition time of CK	1	10	1	10	ns	
tIS	Input Setup time(all inputs)	7		7		ns	
tIH	Input Hold time(all inputs)	0		0		ns	
tRC	Row cycle time	70		70		ns	
tRCD	Row to Column Delay	20		20		ns	
tRAS	Row Active time	50	100k	50	100k	ns	
tRP	Row Precharge time	20		20		ns	
tWR	Write Recovery time	20		20		ns	
tRRD	Act to Act Delay time	20		20		ns	
tCCD	Col to Col Delay time	10		10		ns	
tRSC	Mode Register Set Cycle time	20		20		ns	
tSRX	Self Refresh Exit time	10		10		ns	
tREF	Refresh Interval time		64		64	ms	

SWITCHING CHARACTERISTICS

(Ta=0 ~ 70°C, Vdd = 3.3 +/- 0.3V, Vss = 0V, unless otherwise noted)

LATCH MODE

Symbol	Parameter	Limits				Unit	Note
		-7		-8			
		Min.	Max.	Min.	Max.		
tAC	Access time from CK	CL=3		6		7	ns
		CL=4		6		6	ns
tOH	Output Hold time from CK	3		3		ns	*1
tOLZ	Delay time, output low impedance from CK	0		0		ns	
tOHZ	Delay time, output high impedance from CK	3	6	3	6	ns	

NOTE)

1.If clock rising time is longer than 1ns,(tr /2-0.5ns) should be added to the parameter.

MH64S72QJA -7,-8

4,831,838,208-BIT (67,108,864-WORD BY 72-BIT) Synchronous DYNAMIC RAM

BUFFER MODE

Symbol	Parameter	Limits				Unit	Note
		-7		-8			
		Min.	Max.	Min.	Max.		
t _{AC}	Access time from CK	CL=2	6		7	ns	*1
		CL=3	6		6	ns	
t _{OH}	Output Hold time from CK	3		3		ns	
t _{OLZ}	Delay time, output low impedance from CK	0		0		ns	
t _{OHZ}	Delay time, output high impedance from CK	3	6	3	6	ns	

NOTE)

1.If clock rising time is longer than 1ns,(tr /2-0.5ns) should be added to the parameter.

Output Load Condition

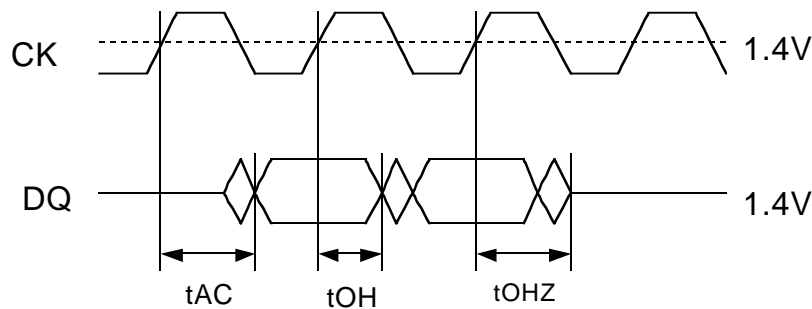
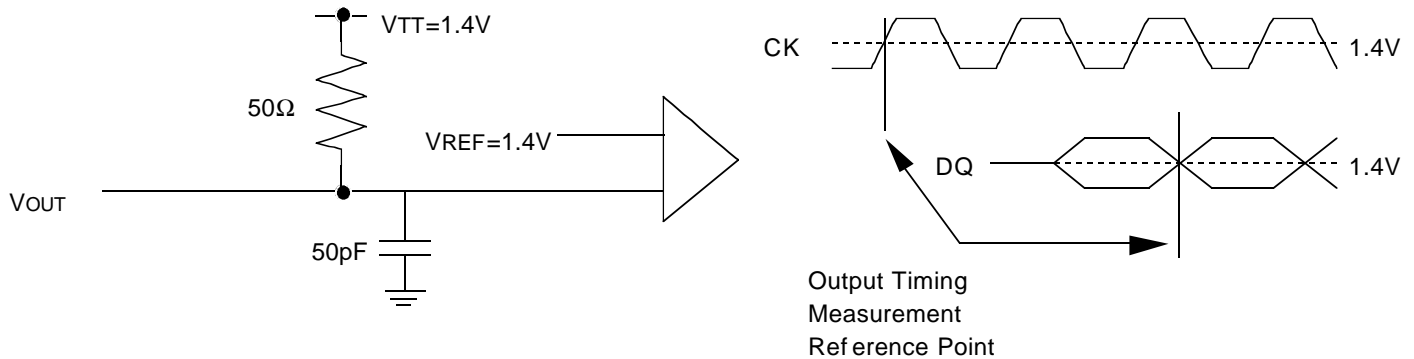

MH64S72QJA -7,-8

4,831,838,208-BIT (67,108,864-WORD BY 72-BIT) Synchronous DYNAMIC RAM

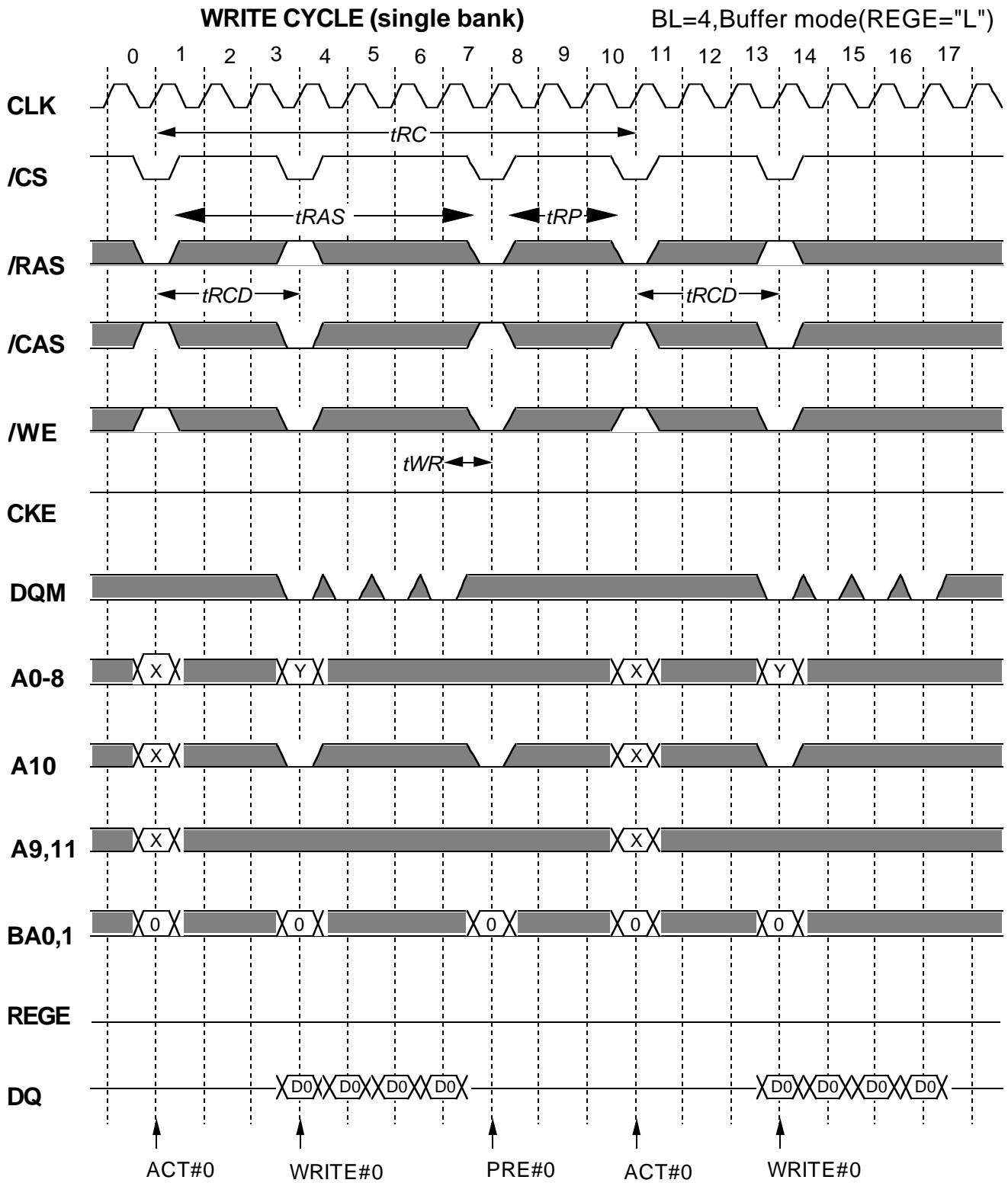

Italic parameter indicates minimum case

MH64S72QJA -7,-8

4,831,838,208-BIT (67,108,864-WORD BY 72-BIT) Synchronous DYNAMIC RAM

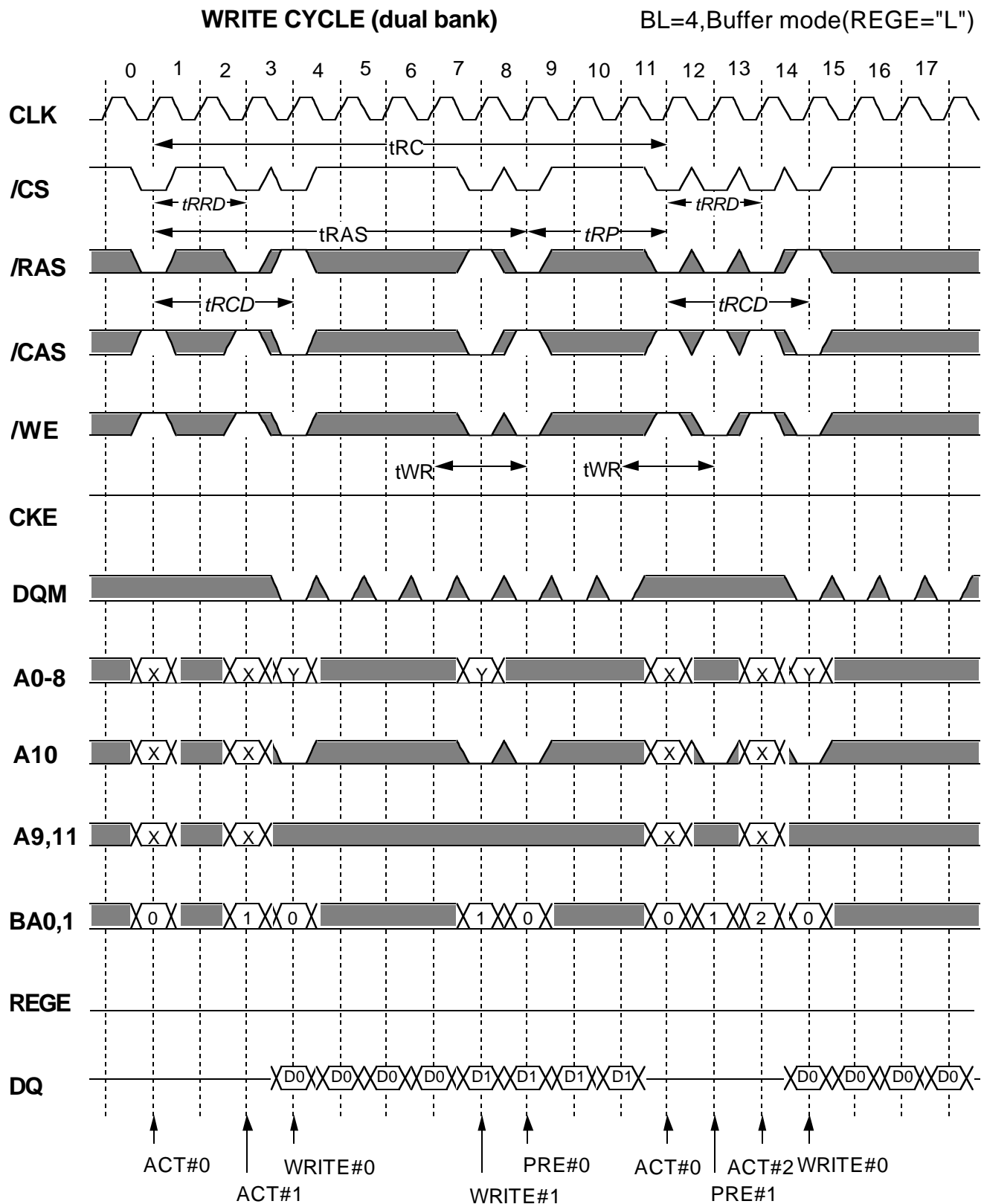

Italic parameter indicates minimum case

MH64S72QJA -7,-8

4,831,838,208-BIT (67,108,864-WORD BY 72-BIT) Synchronous DYNAMIC RAM

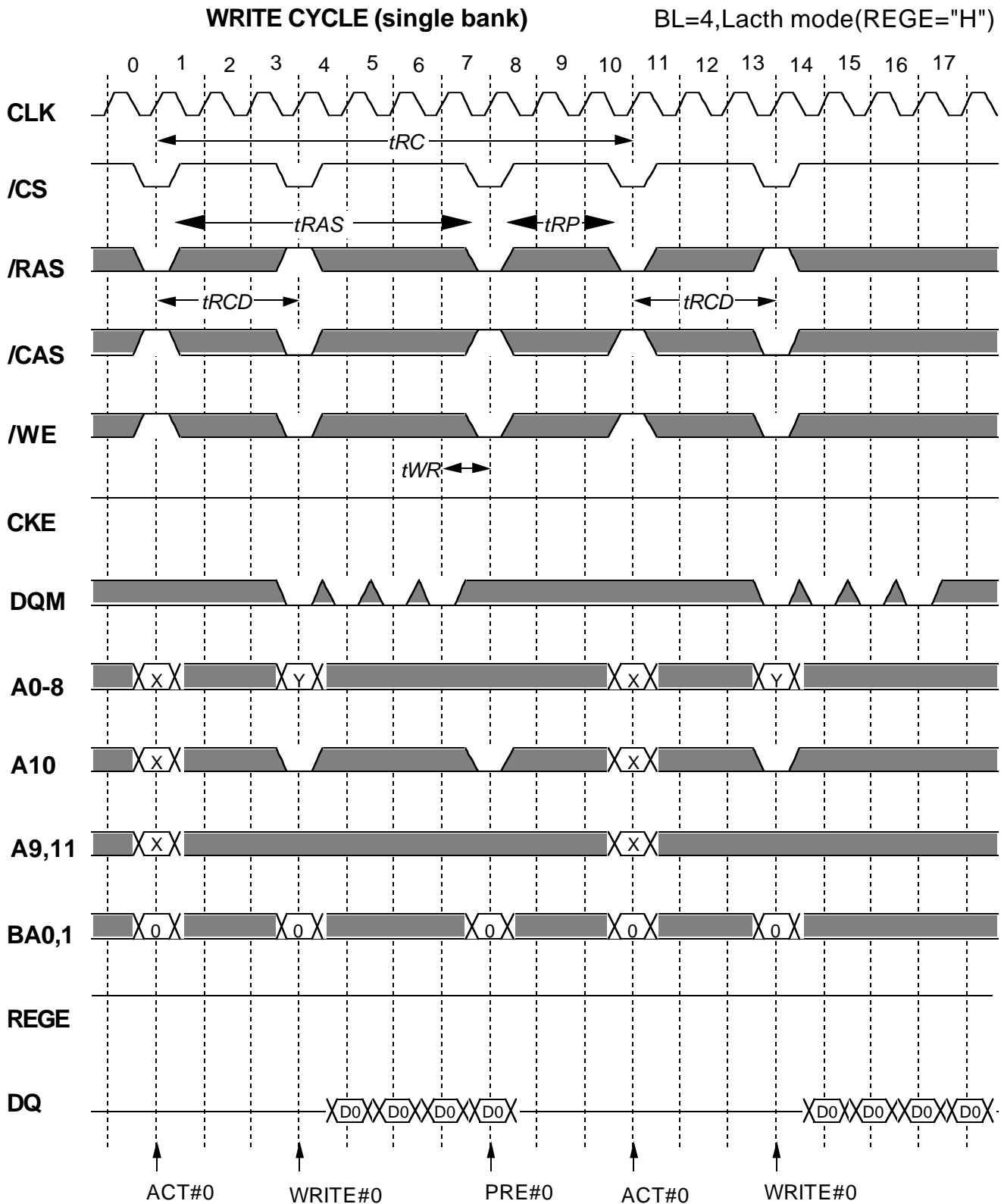

Italic parameter indicates minimum case

Preliminary
Spec.

MH64S72QJA -7,-8

4,831,838,208-BIT (67,108,864-WORD BY 72-BIT) Synchronous DYNAMIC RAM

WRITE CYCLE (dual bank)

BL=4,Latch mode(REGE="H")

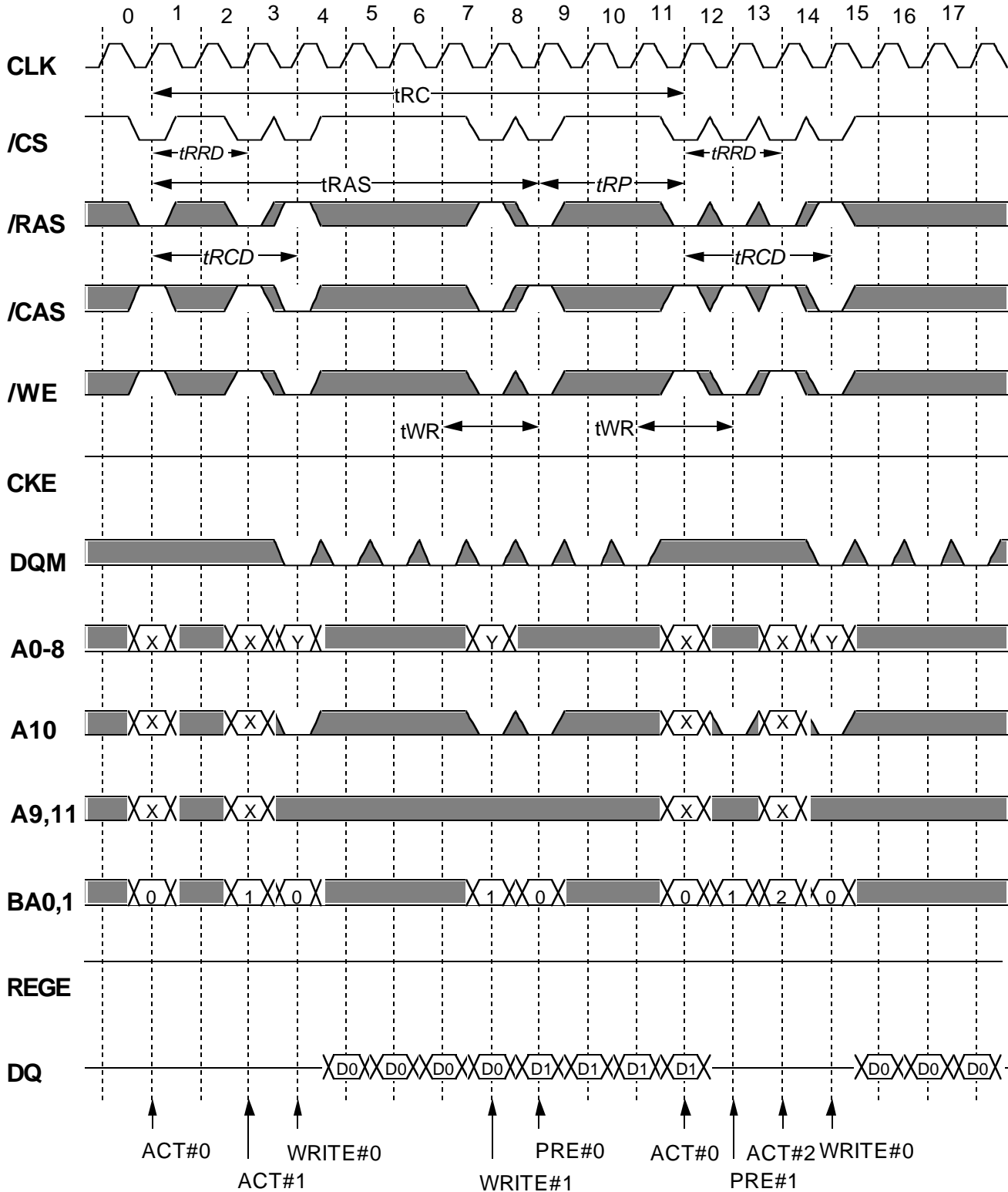

Italic parameter indicates minimum case

MH64S72QJA -7,-8

4,831,838,208-BIT (67,108,864-WORD BY 72-BIT) Synchronous DYNAMIC RAM

READ CYCLE (single bank)

BL=4,CL=3,Buffer mode(REGE="L")

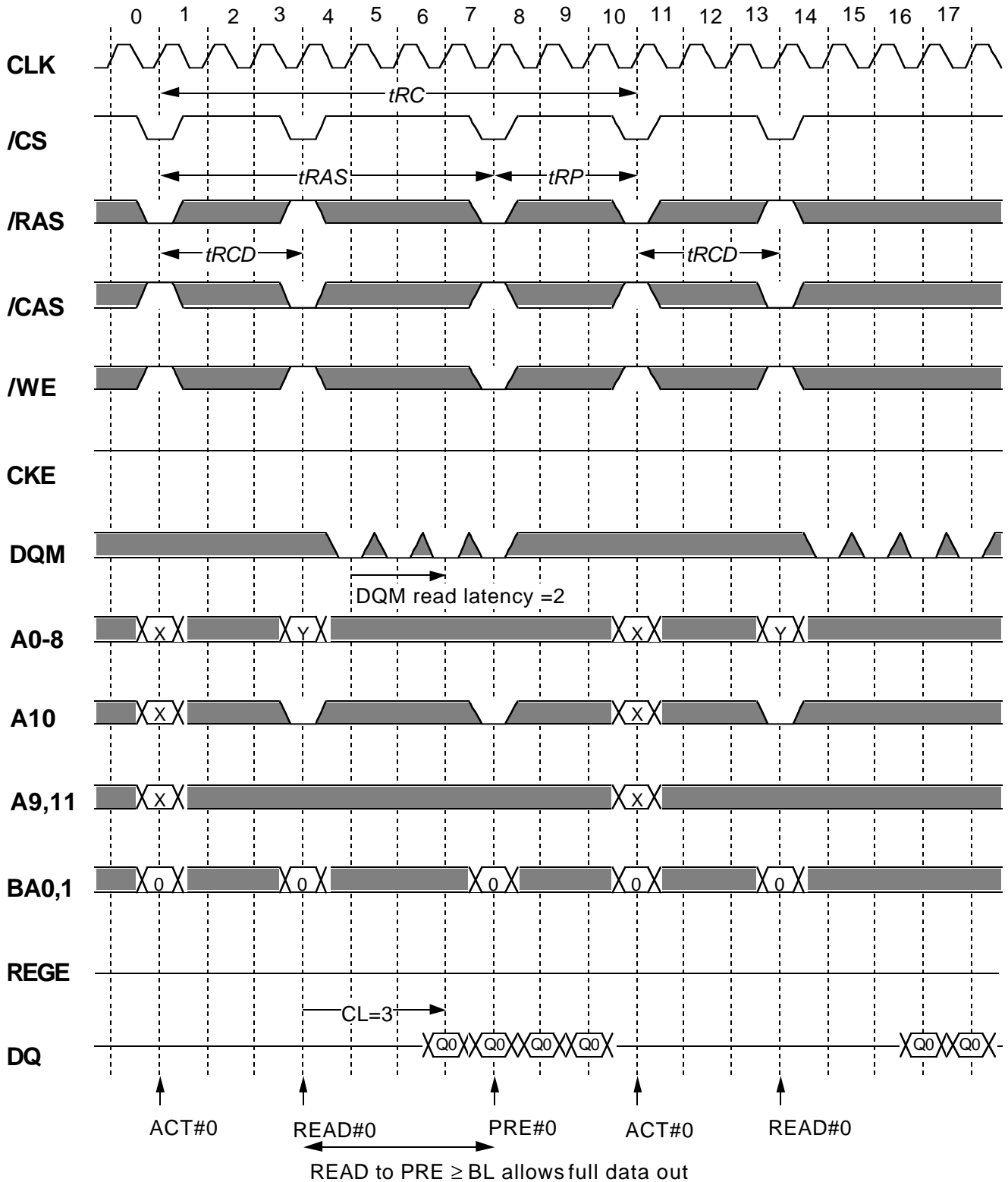

Italic parameter indicates minimum case

MH64S72QJA -7,-8

4,831,838,208-BIT (67,108,864-WORD BY 72-BIT) Synchronous DYNAMIC RAM

READ CYCLE (dual bank)

BL=4,CL=3,Buffer mode(REGE="L")

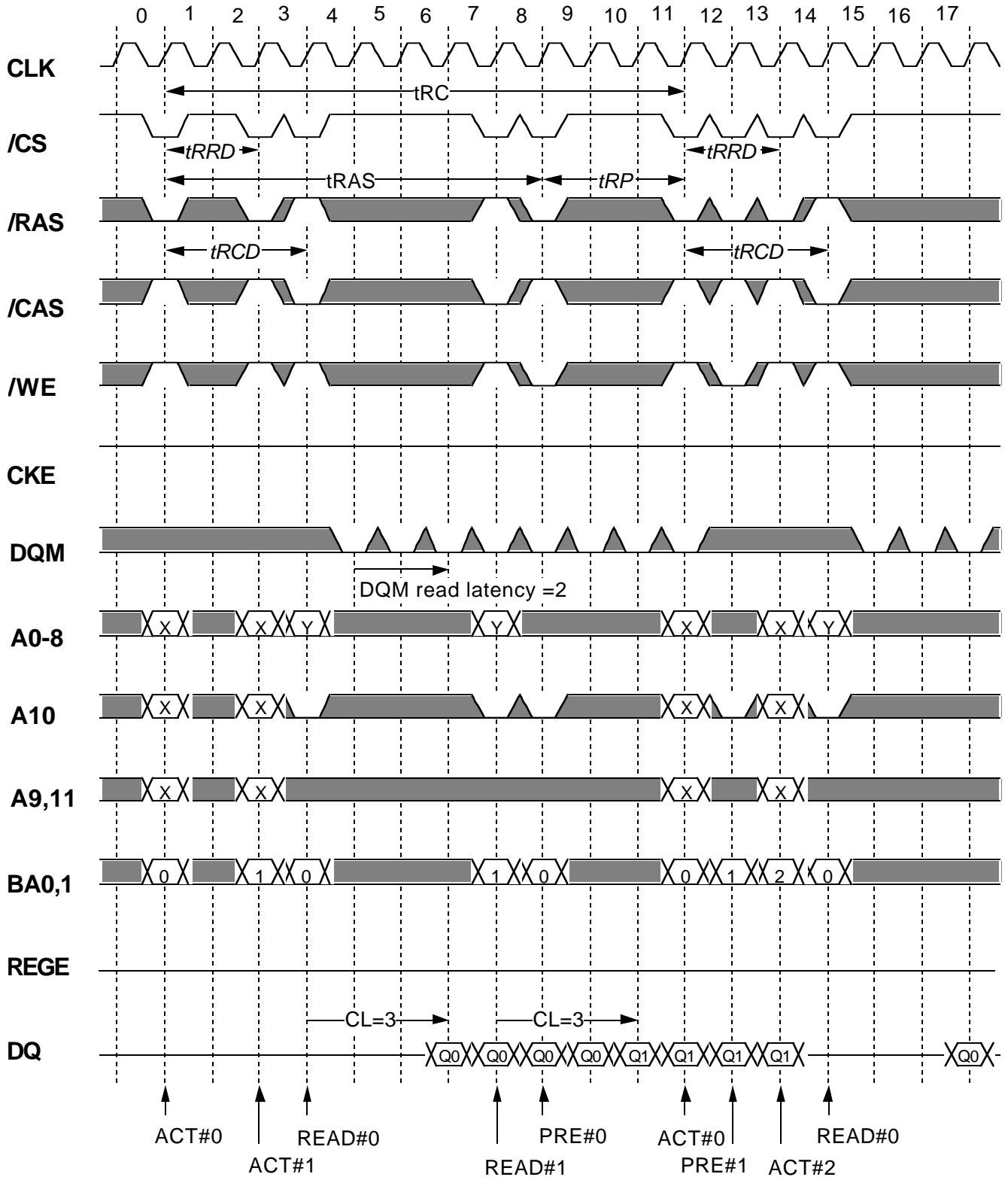

Italic parameter indicates minimum case

Preliminary
Spec.

MH64S72QJA -7,-8

4,831,838,208-BIT (67,108,864-WORD BY 72-BIT) Synchronous DYNAMIC RAM

READ CYCLE (single bank)

BL=4, CL=3, Latch mode (REGE="H")

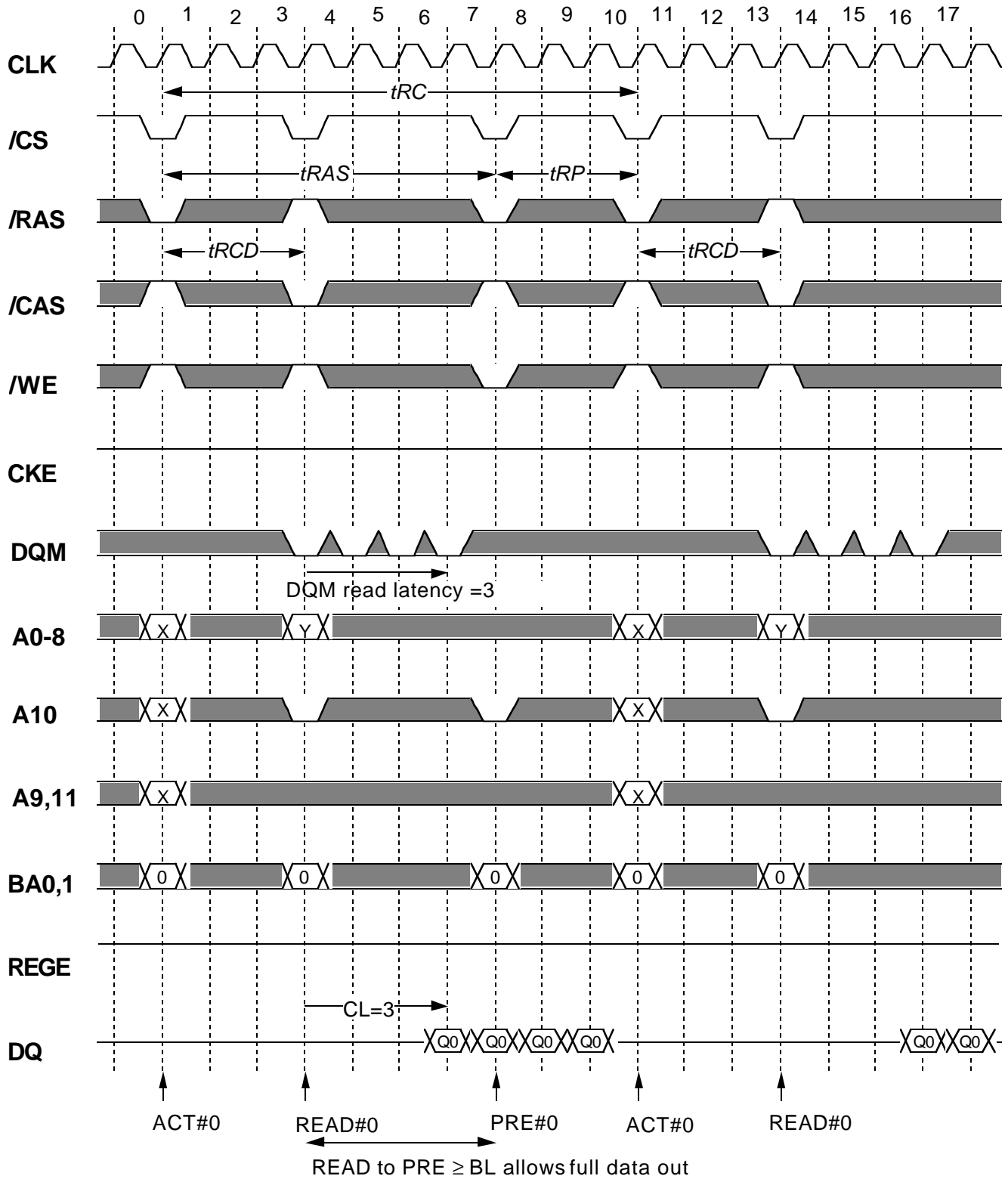

Italic parameter indicates minimum case

MH64S72QJA -7,-8

4,831,838,208-BIT (67,108,864-WORD BY 72-BIT) Synchronous DYNAMIC RAM

READ CYCLE (dual bank)

BL=4,CL=3,Latch mode(REGE="H")

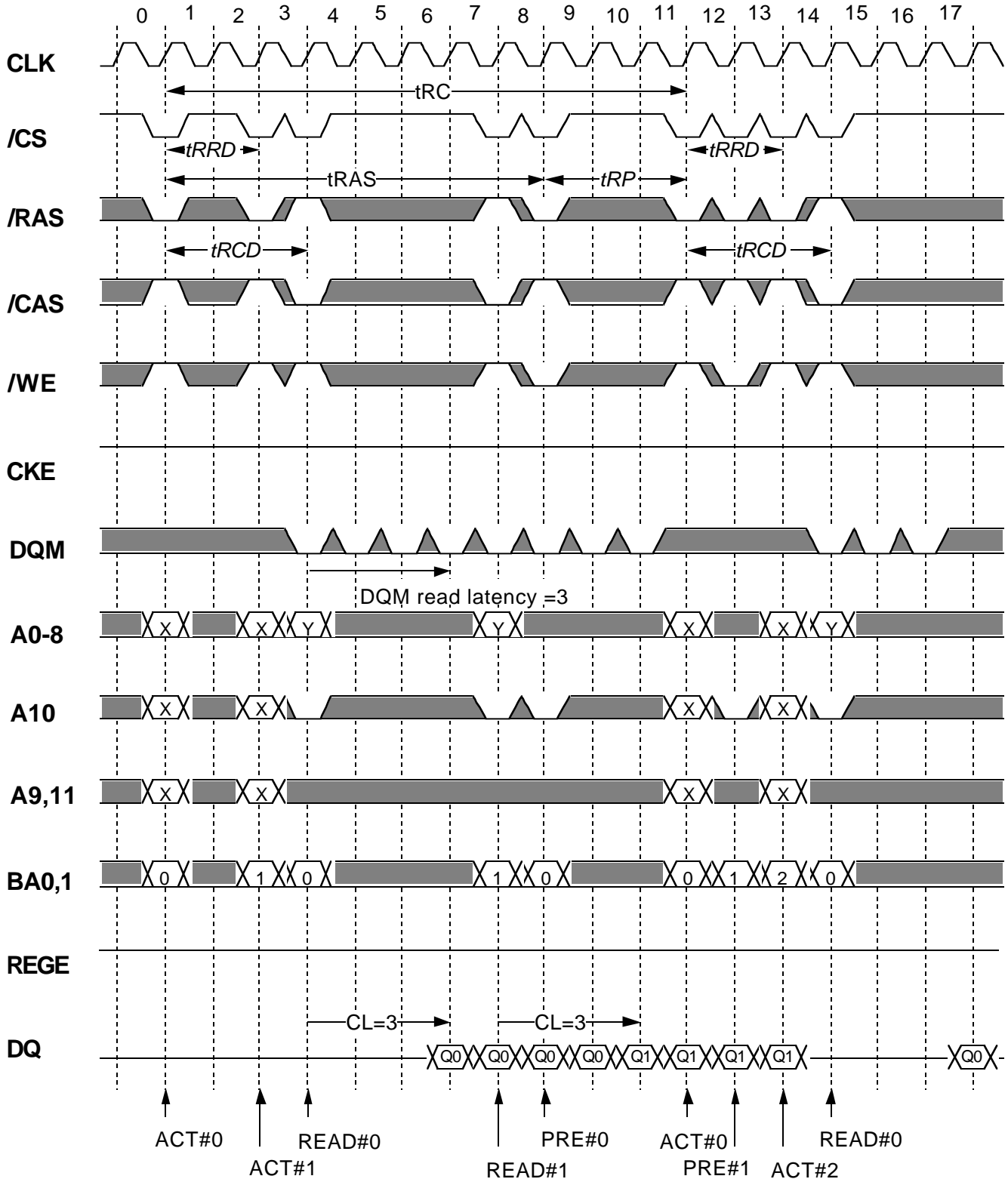

Italic parameter indicates minimum case

Preliminary
Spec.

MH64S72QJA -7,-8

4,831,838,208-BIT (67,108,864-WORD BY 72-BIT) Synchronous DYNAMIC RAM

Burst WRITE (multi bank) with AUTO-PRECHARGE

BL=4, Buffer mode(REGE="L")

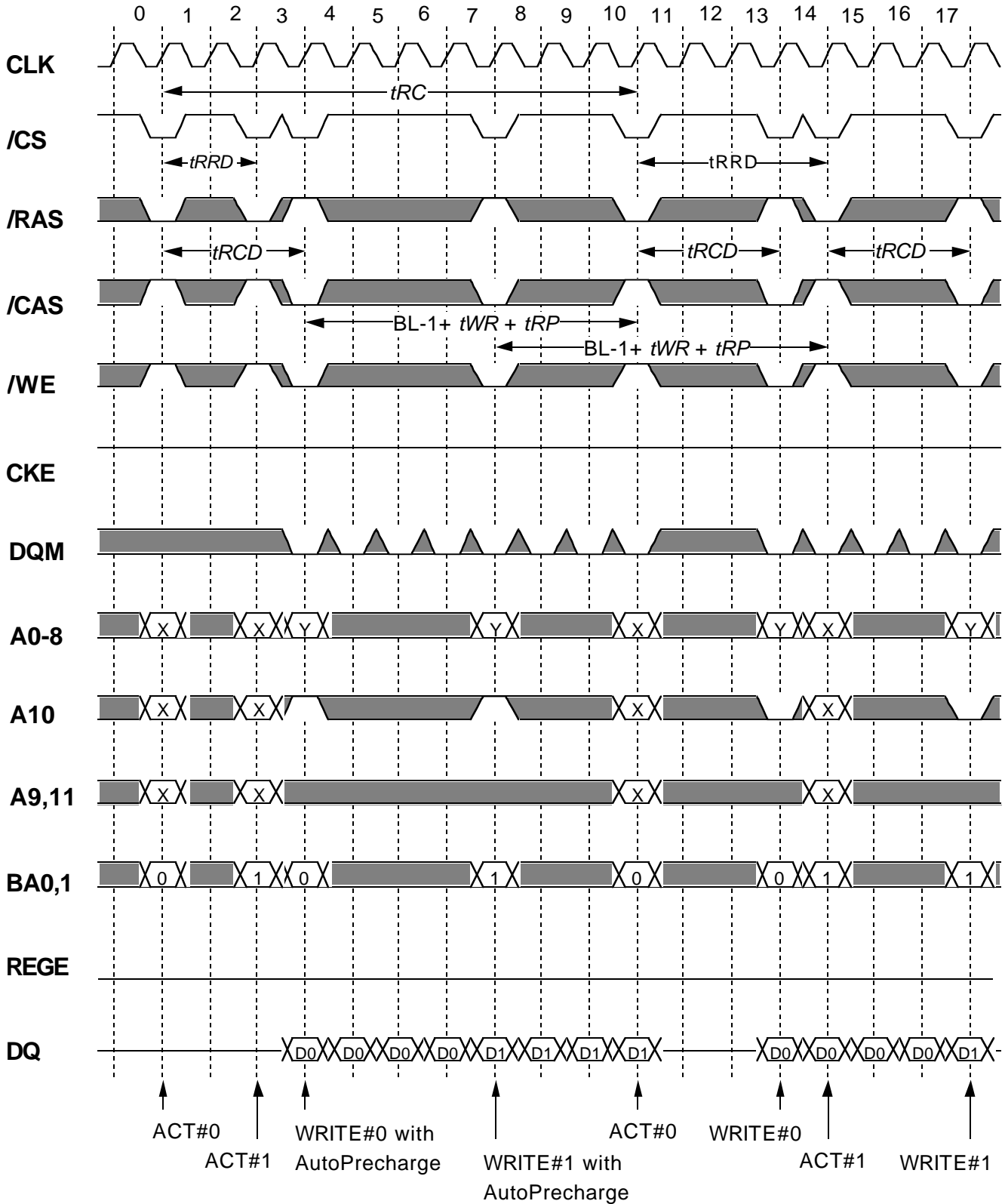

Italic parameter indicates minimum case

MH64S72QJA -7,-8

4,831,838,208-BIT (67,108,864-WORD BY 72-BIT) Synchronous DYNAMIC RAM

Burst WRITE (multi bank) with AUTO-PRECHARGE BL=4,Latch mode(REGE="H")

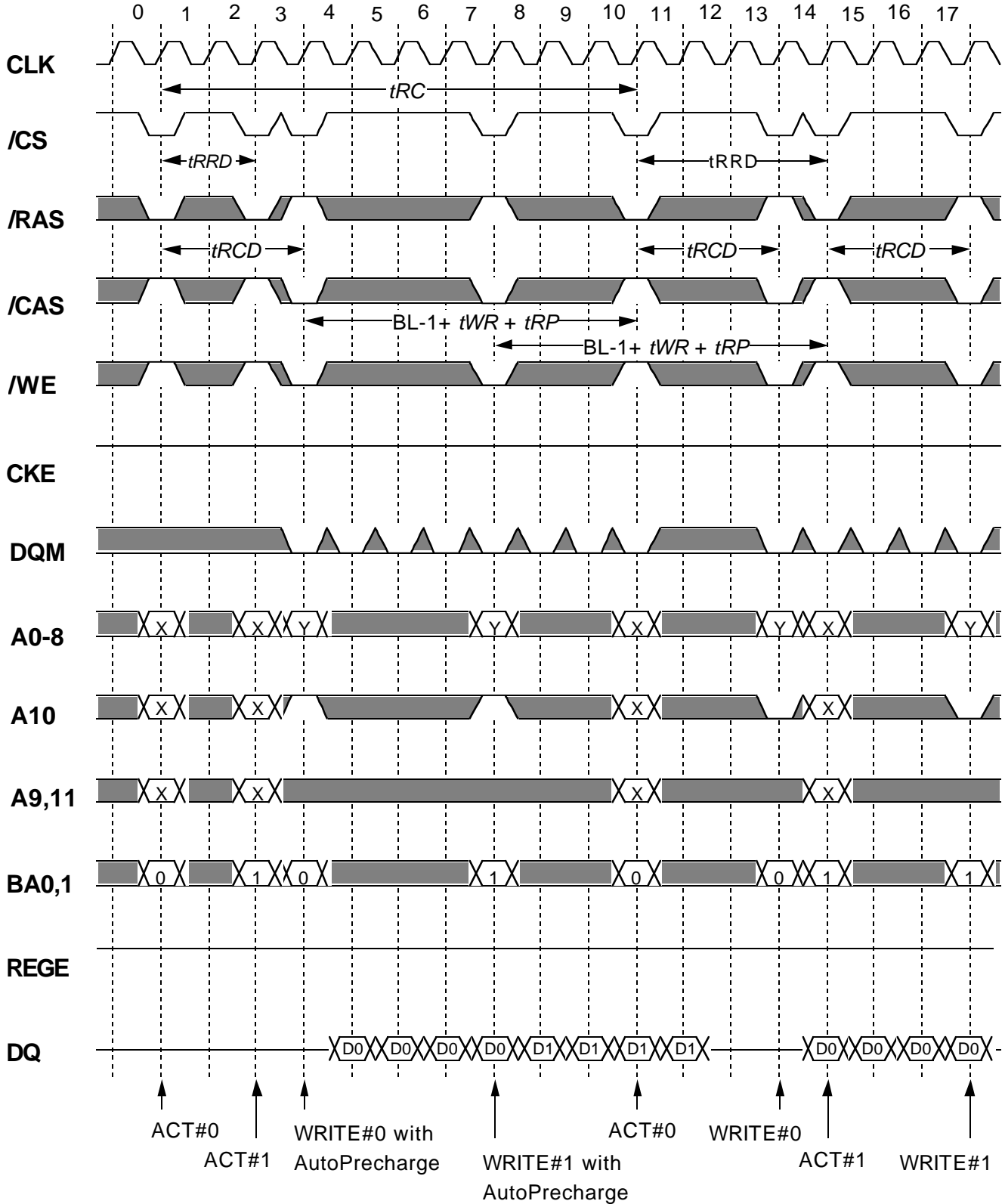

Italic parameter indicates minimum case

Preliminary Spec.

MH64S72QJA -7,-8

4,831,838,208-BIT (67,108,864-WORD BY 72-BIT) Synchronous DYNAMIC RAM

Burst READ (multi bank) with AUTO-PRECHARGE

BL=4, Buffer mode(REGE="L")

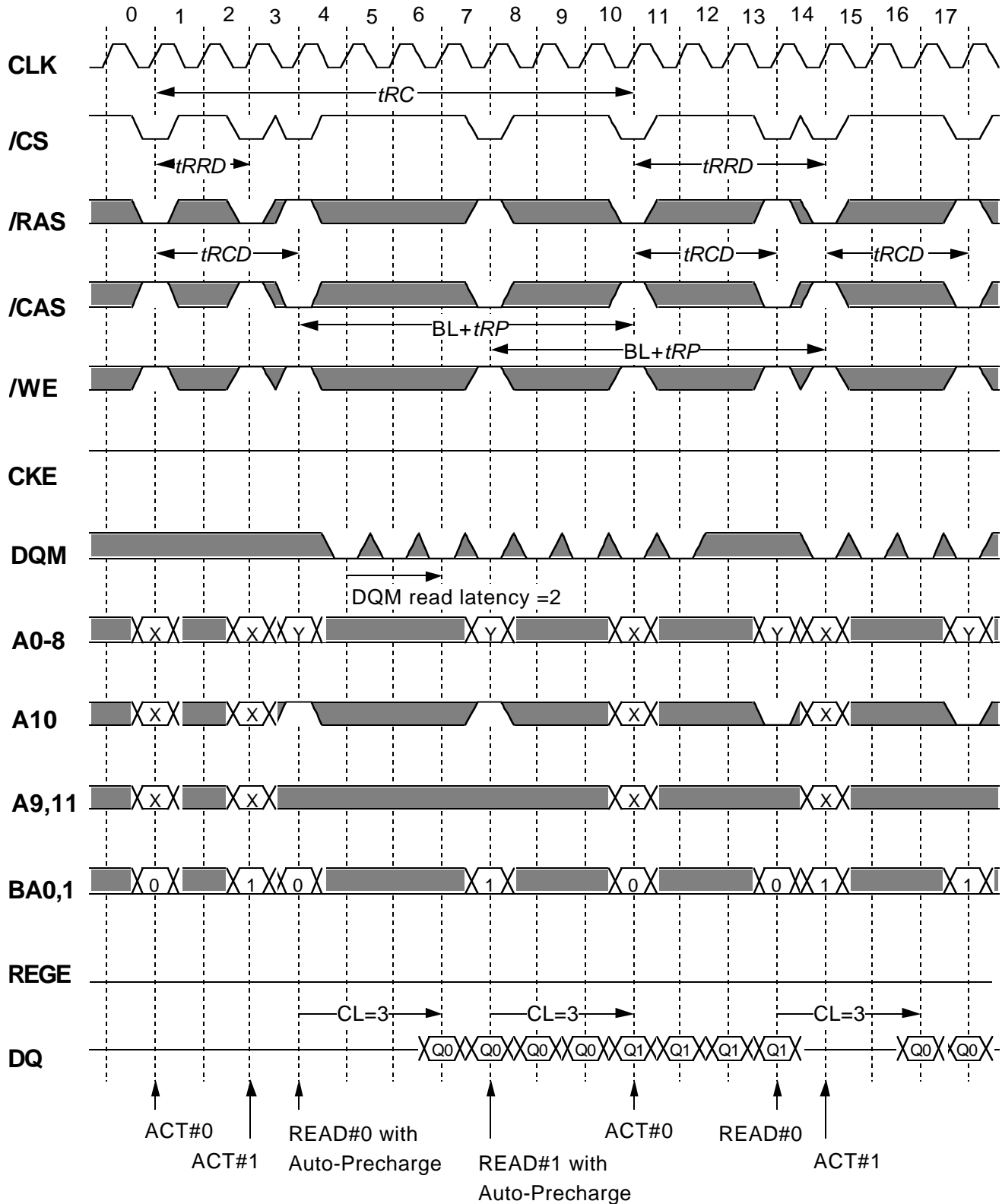

Italic parameter indicates minimum case

Preliminary Spec.

MH64S72QJA -7,-8

4,831,838,208-BIT (67,108,864-WORD BY 72-BIT) Synchronous DYNAMIC RAM

Burst READ (multi bank) with AUTO-PRECHARGE

BL=4,Latch mode(REGE="H")

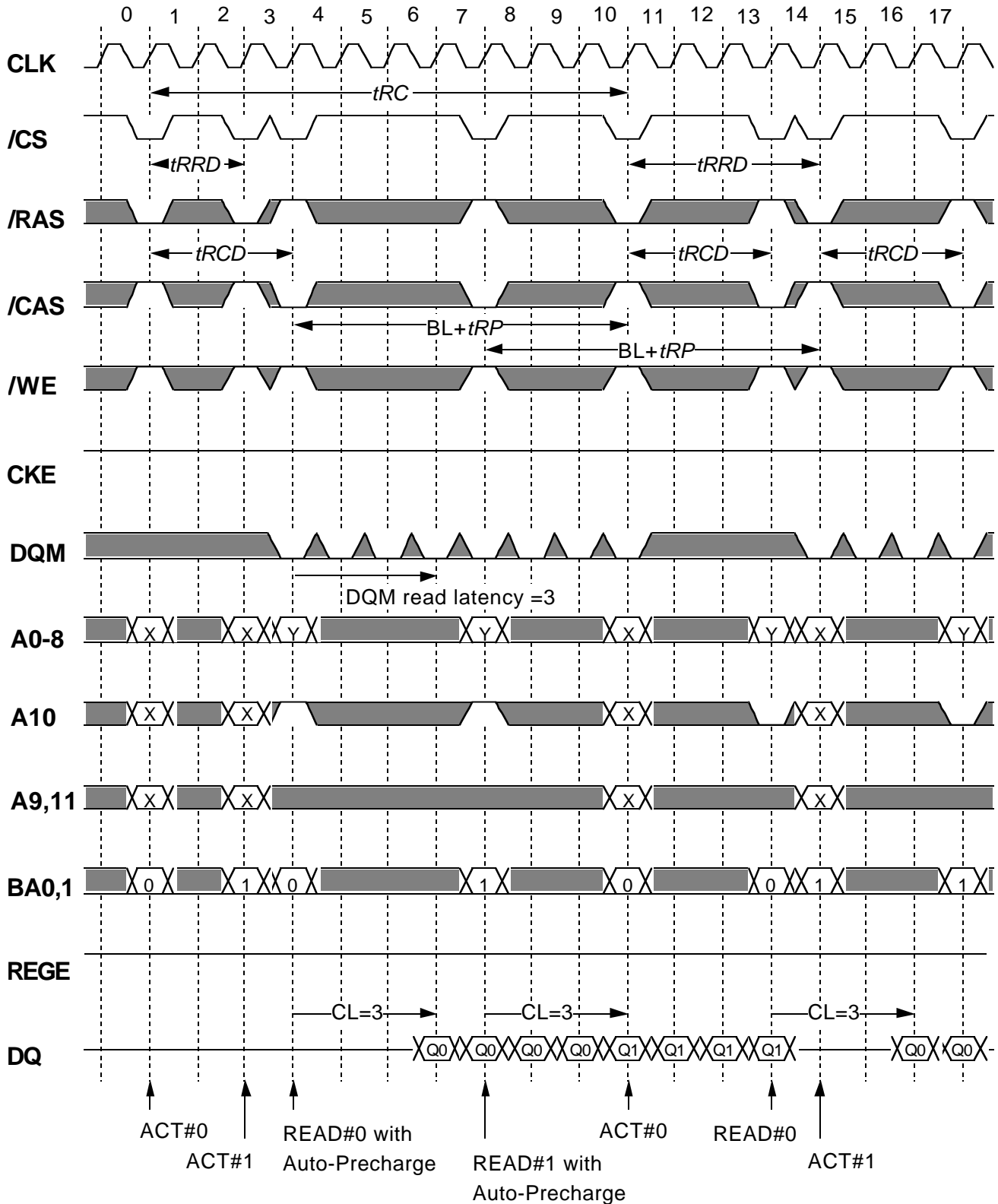

Italic parameter indicates minimum case

MH64S72QJA -7,-8

4,831,838,208-BIT (67,108,864-WORD BY 72-BIT) Synchronous DYNAMIC RAM

Page Mode Burst Write (multi bank)

BL=4, Buffer mode(REGE="L")

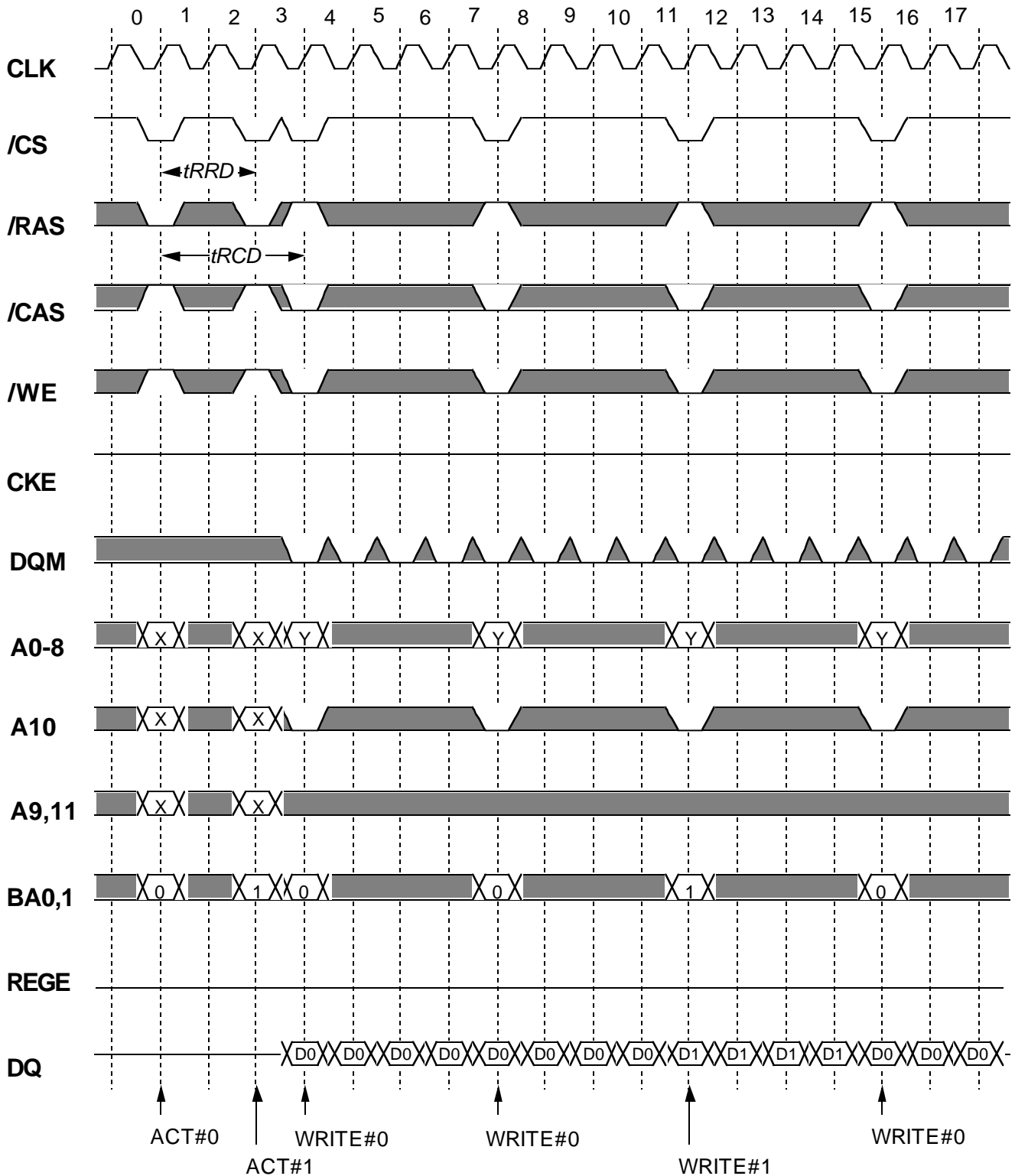

Italic parameter indicates minimum case

MH64S72QJA -7,-8

4,831,838,208-BIT (67,108,864-WORD BY 72-BIT) Synchronous DYNAMIC RAM

Page Mode Burst Write (multi bank)

BL=4,Latch mode(REGE="H")

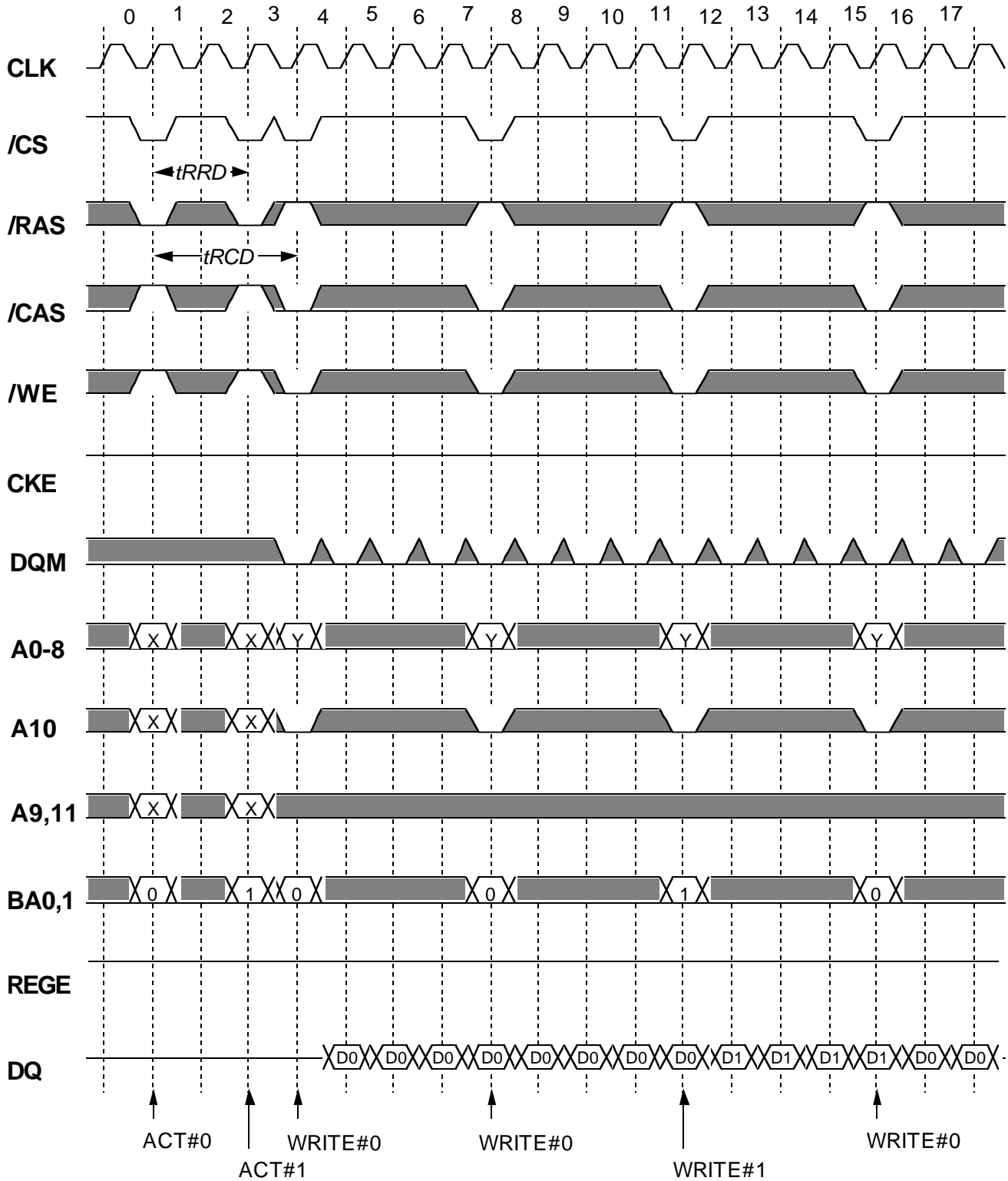

Italic parameter indicates minimum case

MH64S72QJA -7,-8

4,831,838,208-BIT (67,108,864-WORD BY 72-BIT) Synchronous DYNAMIC RAM

Page Mode Burst Read (multi bank)

BL=4, Buffer mode (REGE="L")

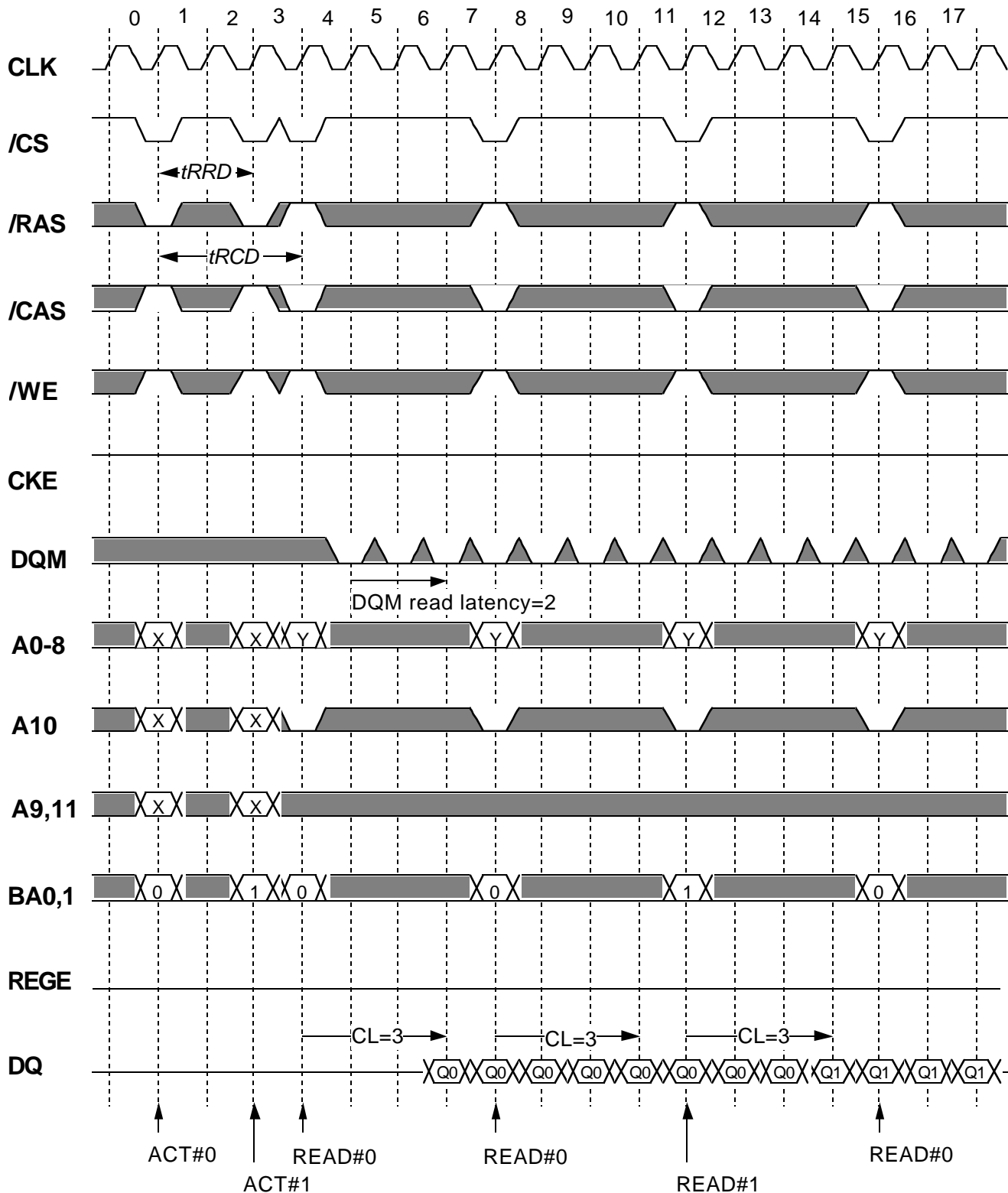

Italic parameter indicates minimum case

Preliminary
Spec.

MH64S72QJA -7,-8

4,831,838,208-BIT (67,108,864-WORD BY 72-BIT) Synchronous DYNAMIC RAM

Page Mode Burst Read (multi bank)

BL=4, Latch mode(REGE="H")

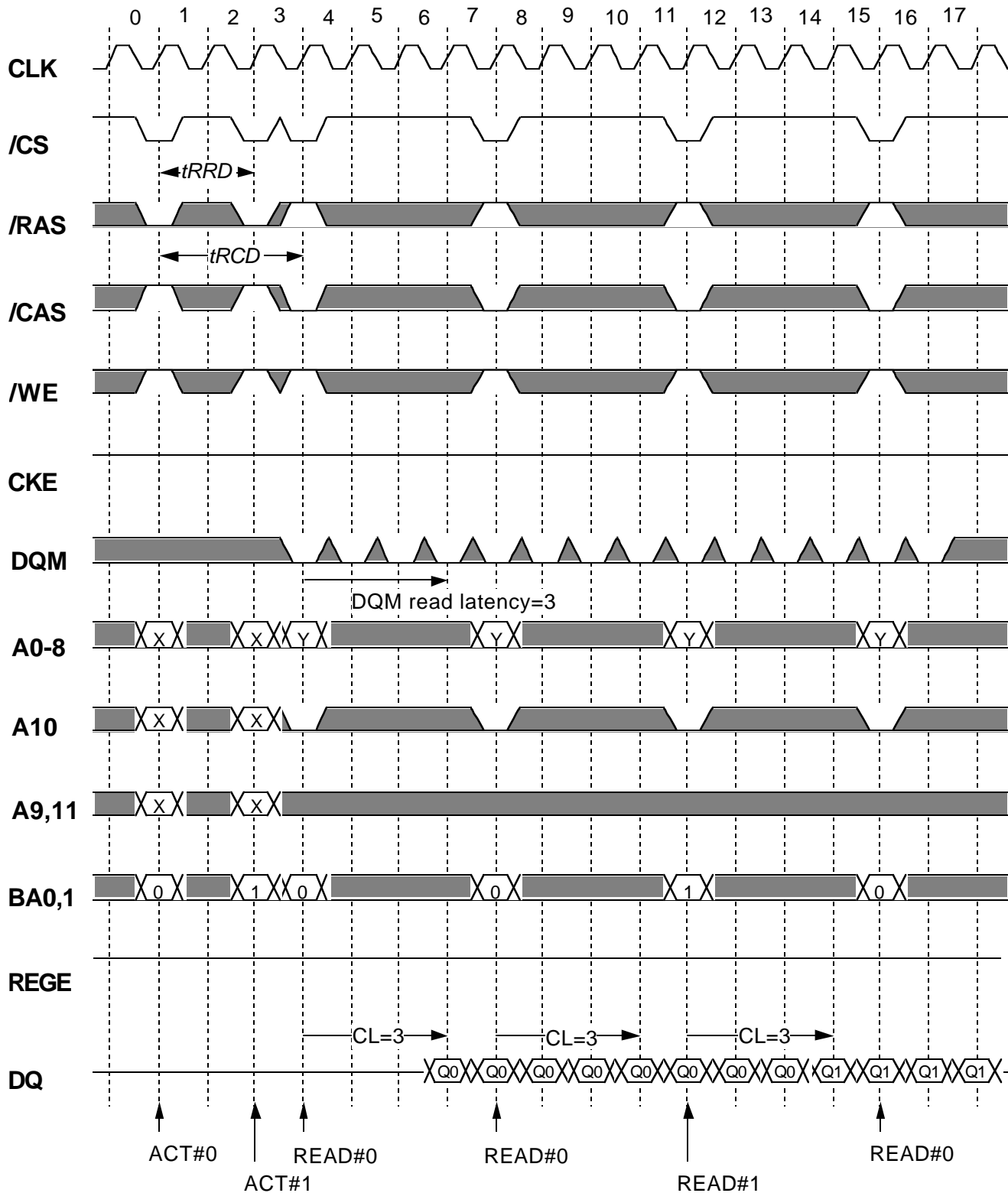

Italic parameter indicates minimum case

MH64S72QJA -7,-8

4,831,838,208-BIT (67,108,864-WORD BY 72-BIT) Synchronous DYNAMIC RAM

Write Interrupted by Write / Read

BL=4, Buffer mode (REGE="L")

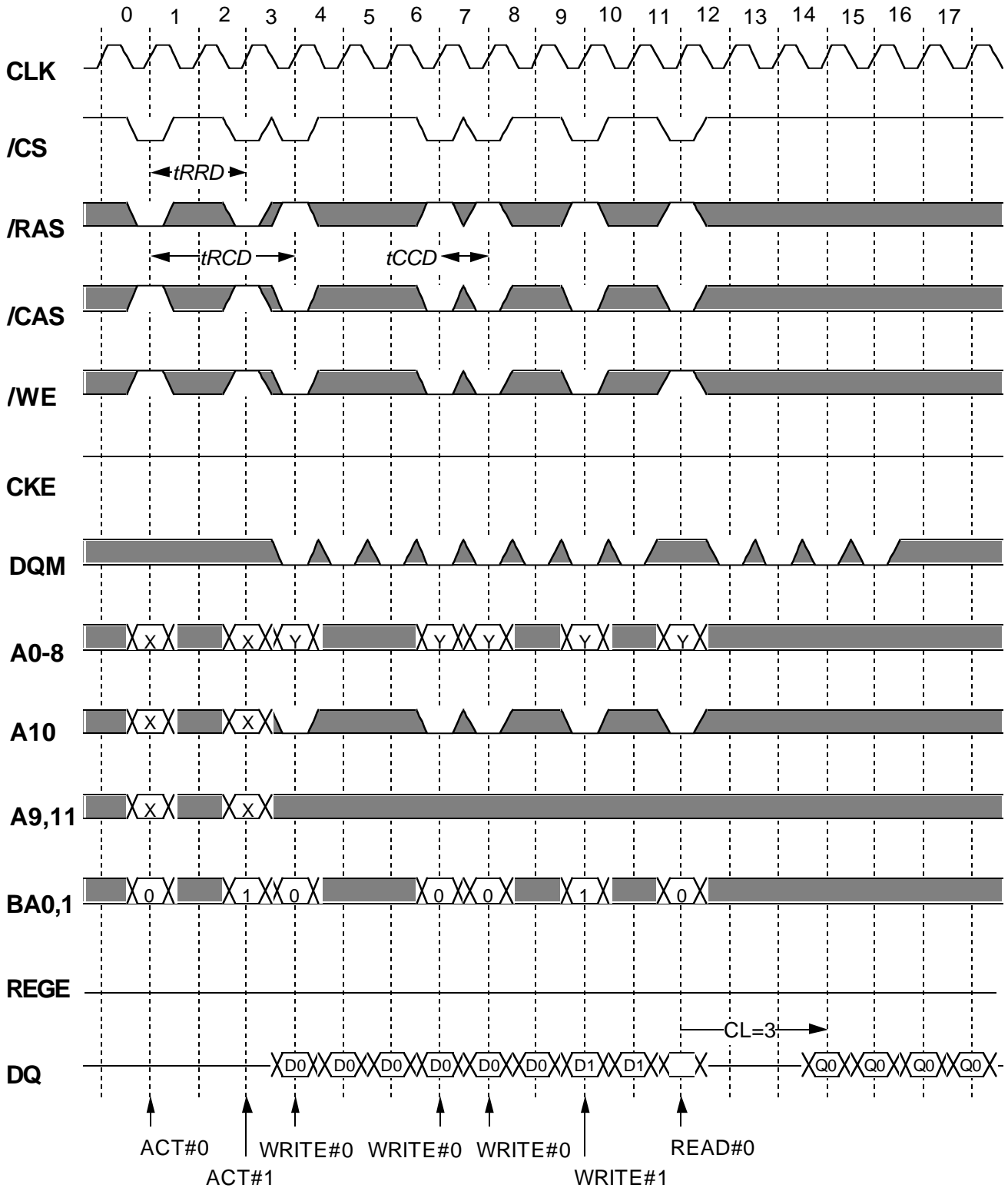

Burst Write can be interrupted by Write or Read of any active bank.

Italic parameter indicates minimum case

MH64S72QJA -7,-8

4,831,838,208-BIT (67,108,864-WORD BY 72-BIT) Synchronous DYNAMIC RAM

Write Interrupted by Write / Read

BL=4, Latch mode (REGE="H")

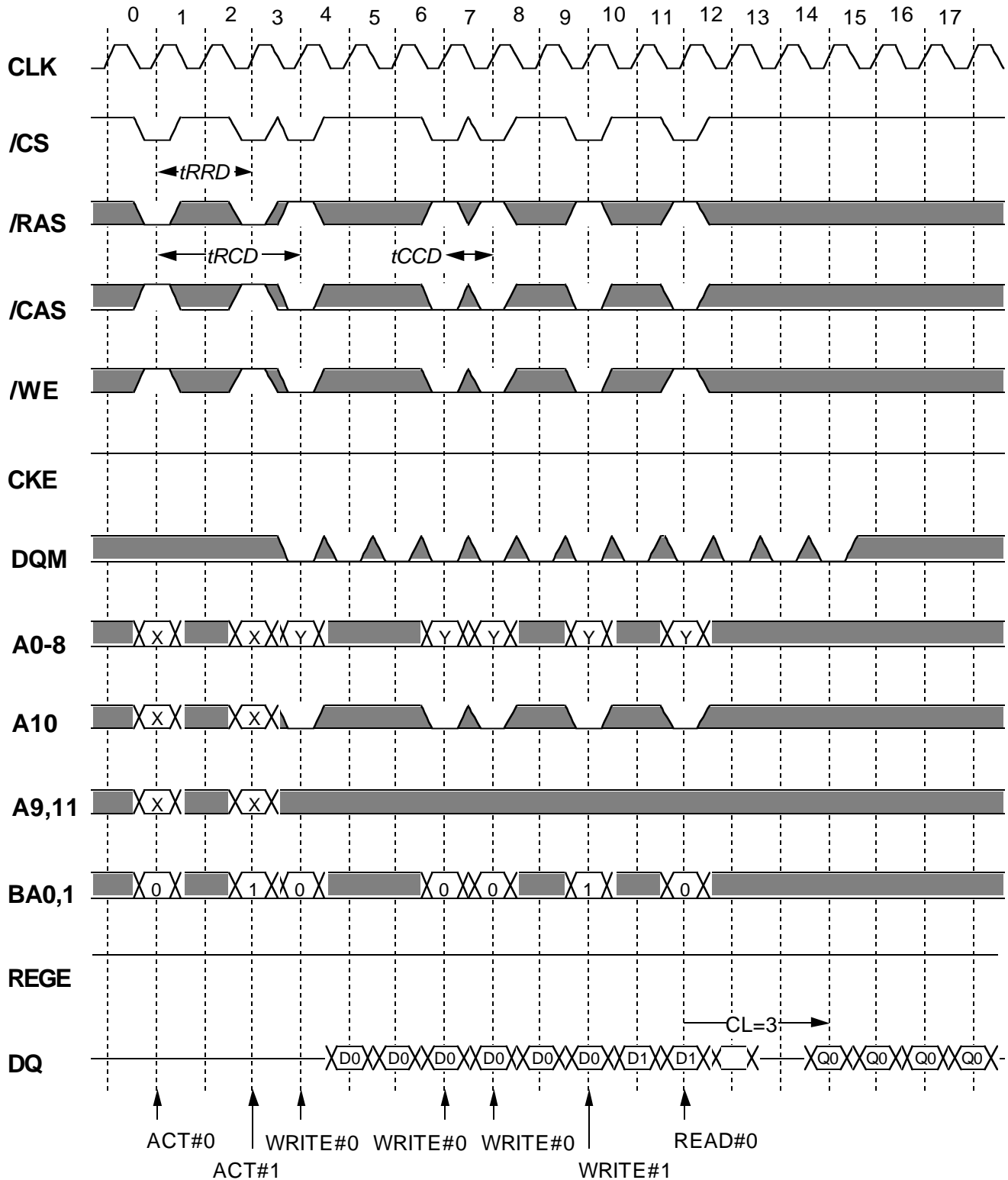

Burst Write can be interrupted by Write or Read of any active bank.

Italic parameter indicates minimum case

MH64S72QJA -7,-8

4,831,838,208-BIT (67,108,864-WORD BY 72-BIT) Synchronous DYNAMIC RAM

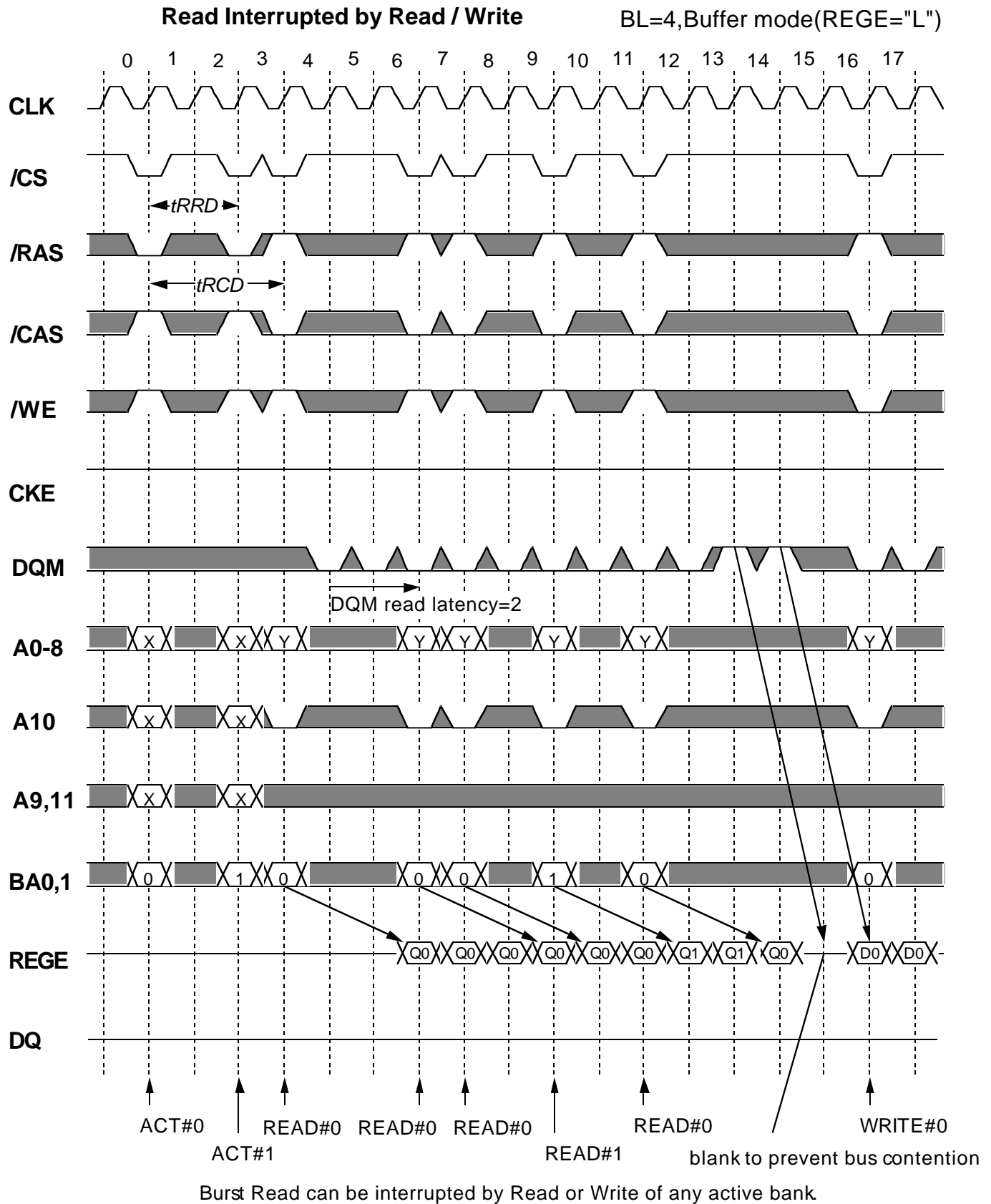

Italic parameter indicates minimum case

Preliminary
Spec.

MH64S72QJA -7,-8

4,831,838,208-BIT (67,108,864-WORD BY 72-BIT) Synchronous DYNAMIC RAM

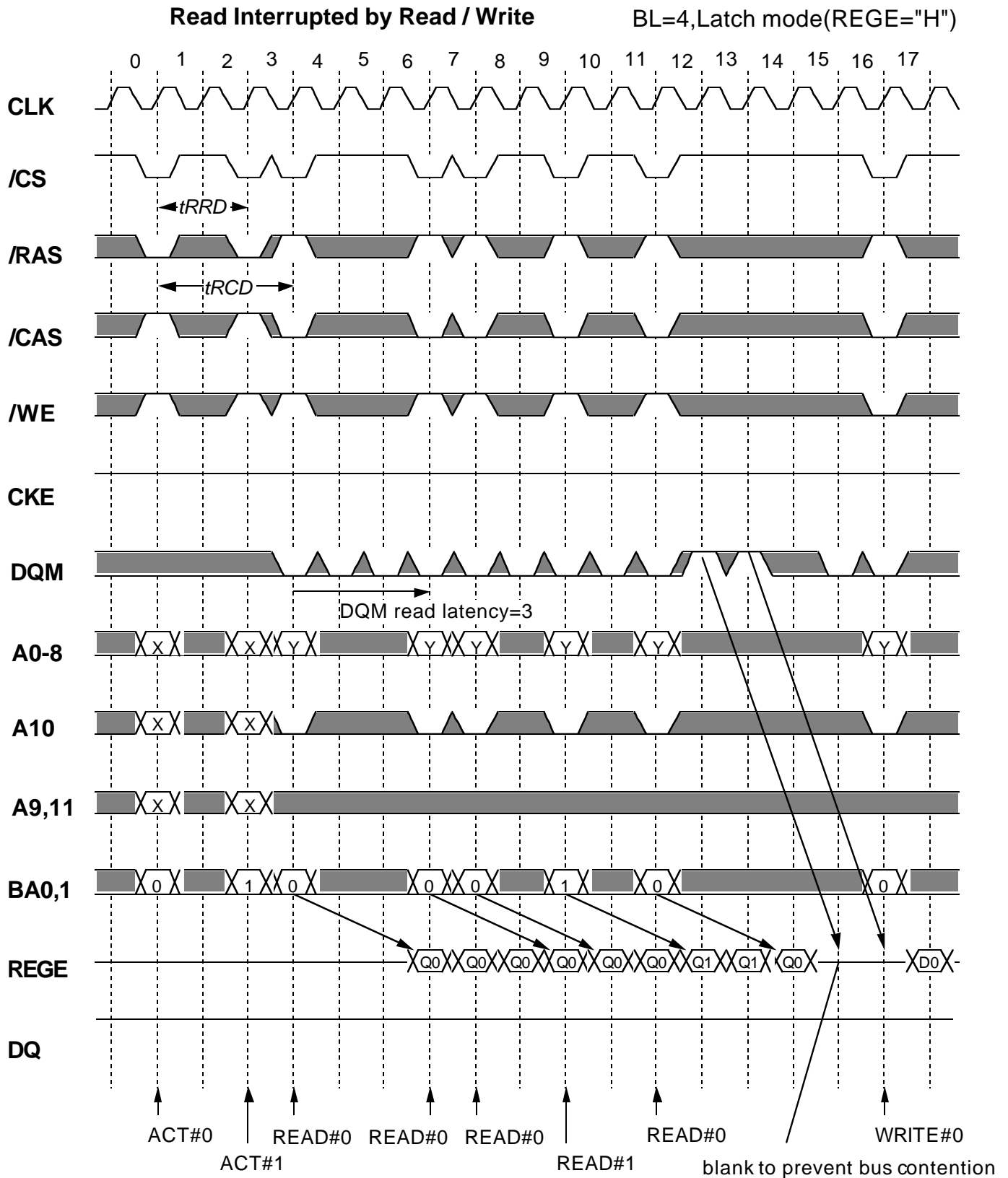

Burst Read can be interrupted by Read or Write of any active bank.

Italic parameter indicates minimum case

Preliminary
Spec.

MH64S72QJA -7,-8

4,831,838,208-BIT (67,108,864-WORD BY 72-BIT) Synchronous DYNAMIC RAM

Write Interrupted by Precharge

BL=4, Buffer mode (REGE="L")

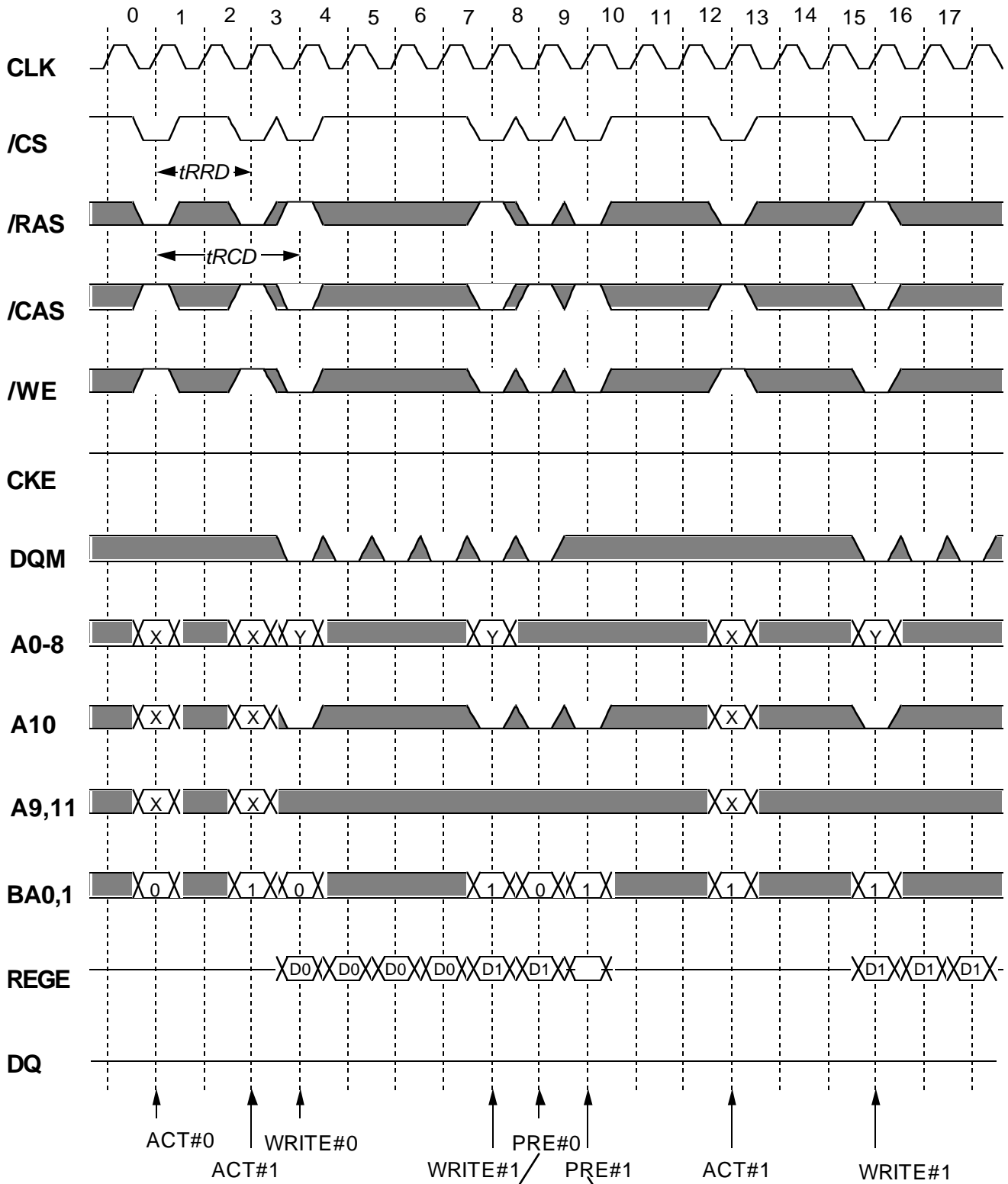

Burst Write is not interrupted by Precharge of the other bank.

Burst Write is interrupted by Precharge of the same bank.

Italic parameter indicates minimum case

MH64S72QJA -7,-8

4,831,838,208-BIT (67,108,864-WORD BY 72-BIT) Synchronous DYNAMIC RAM

Write Interrupted by Precharge

BL=4, Latch mode (REGE="H")

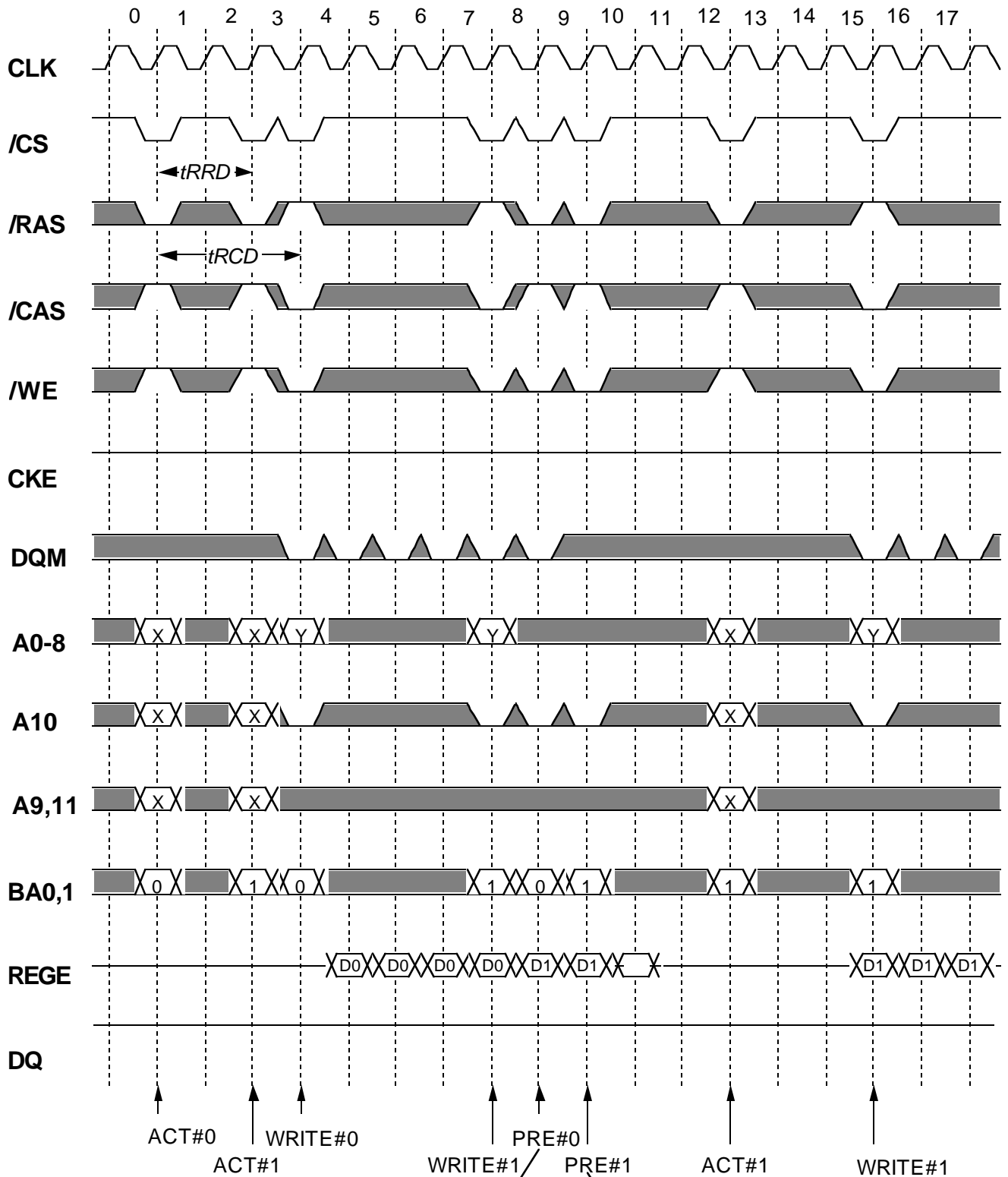

Burst Write is not interrupted by Precharge of the other bank

Burst Write is interrupted by Precharge of the same bank

Italic parameter indicates minimum case

MH64S72QJA -7,-8

4,831,838,208-BIT (67,108,864-WORD BY 72-BIT) Synchronous DYNAMIC RAM

Read Interrupted by Precharge

BL=4, Buffer mode (REGE="L")

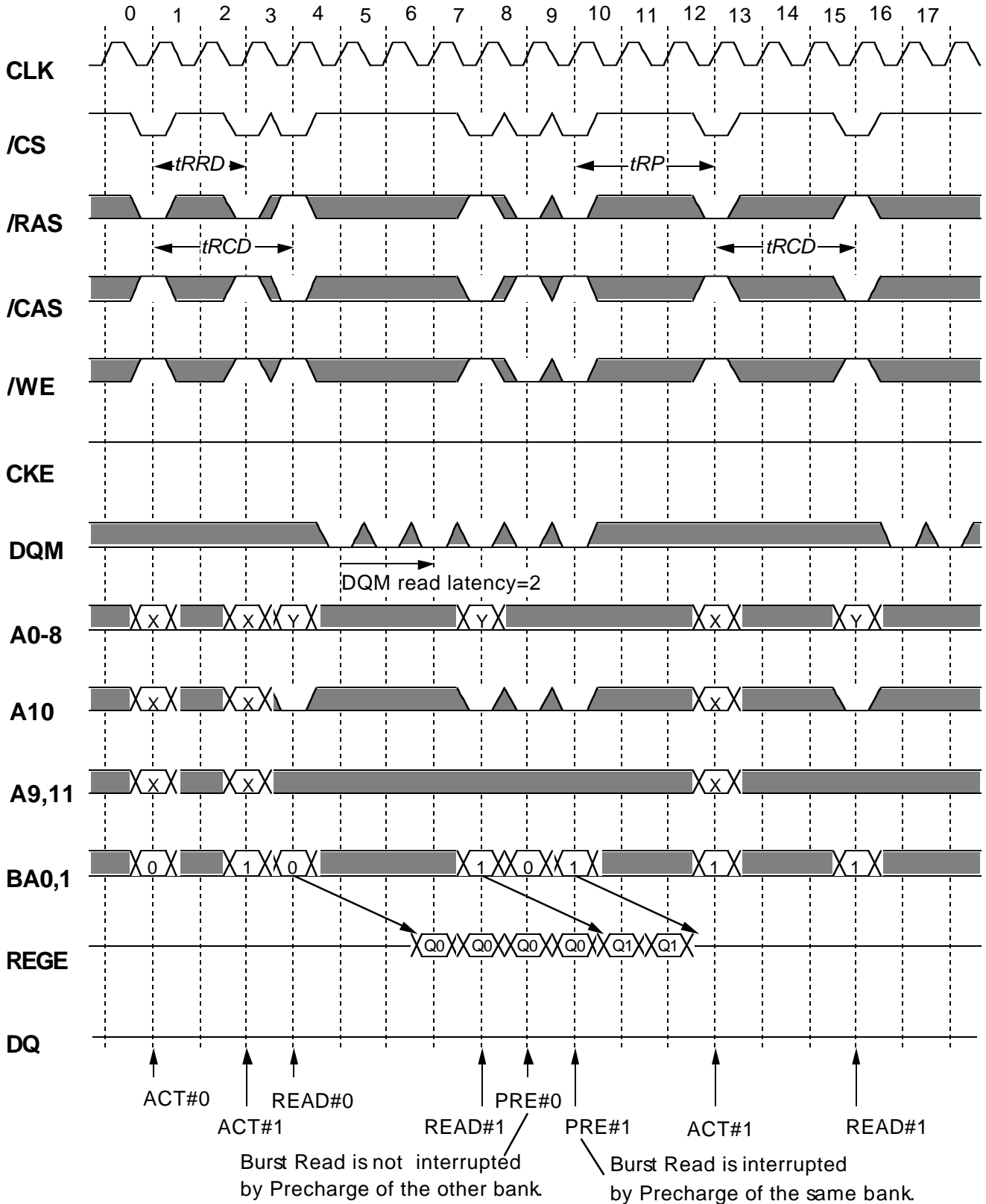

Burst Read is not interrupted by Precharge of the other bank

Burst Read is interrupted by Precharge of the same bank

Italic parameter indicates minimum case

MH64S72QJA -7,-8

4,831,838,208-BIT (67,108,864-WORD BY 72-BIT) Synchronous DYNAMIC RAM

Read Interrupted by Precharge

BL=4,Latch mode(REGE="H")

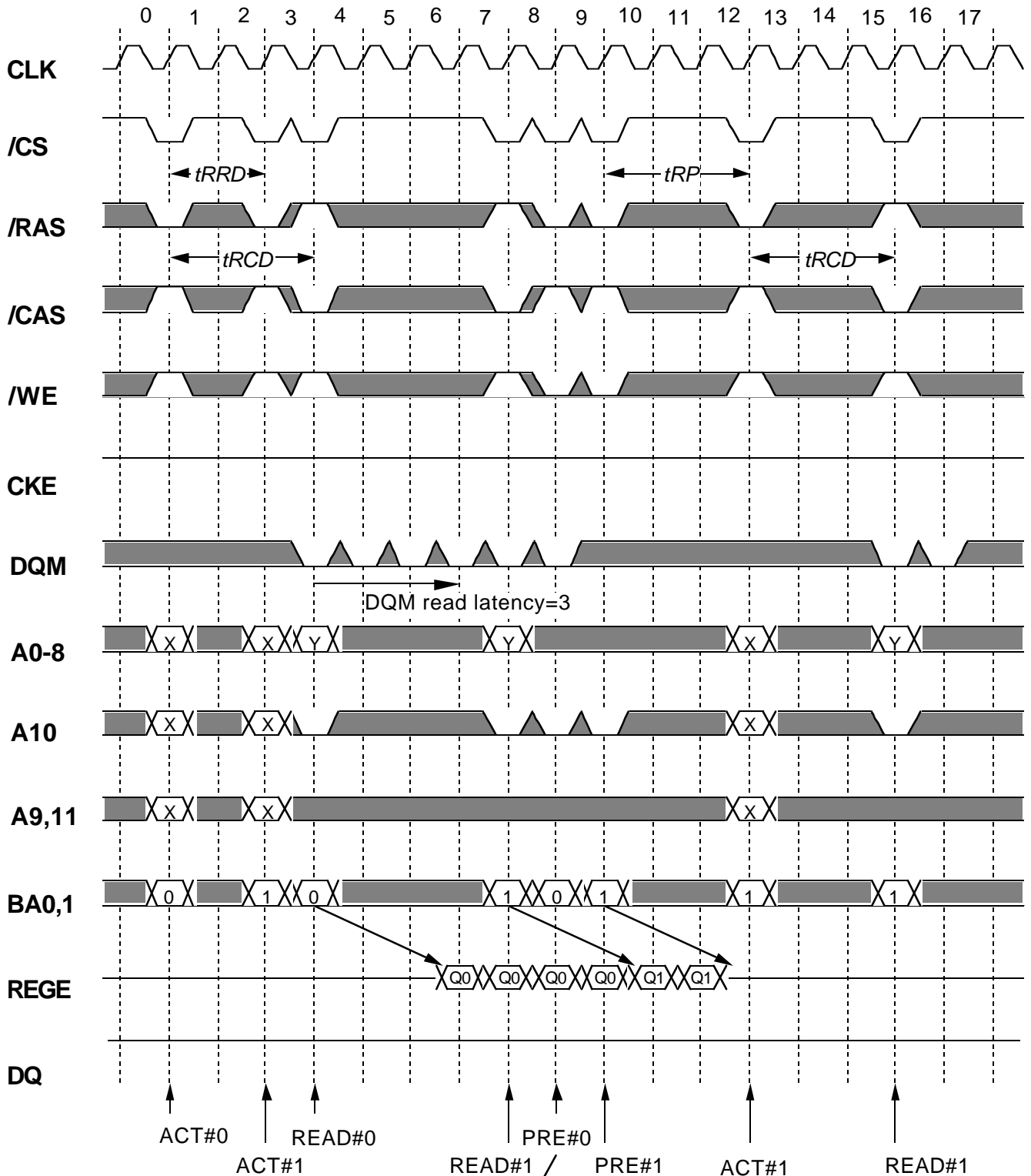

Burst Read is not interrupted by Precharge of the other bank.

Burst Read is interrupted by Precharge of the same bank.

Italic parameter indicates minimum case

MH64S72QJA -7,-8

4,831,838,208-BIT (67,108,864-WORD BY 72-BIT) Synchronous DYNAMIC RAM

Mode Register Setting

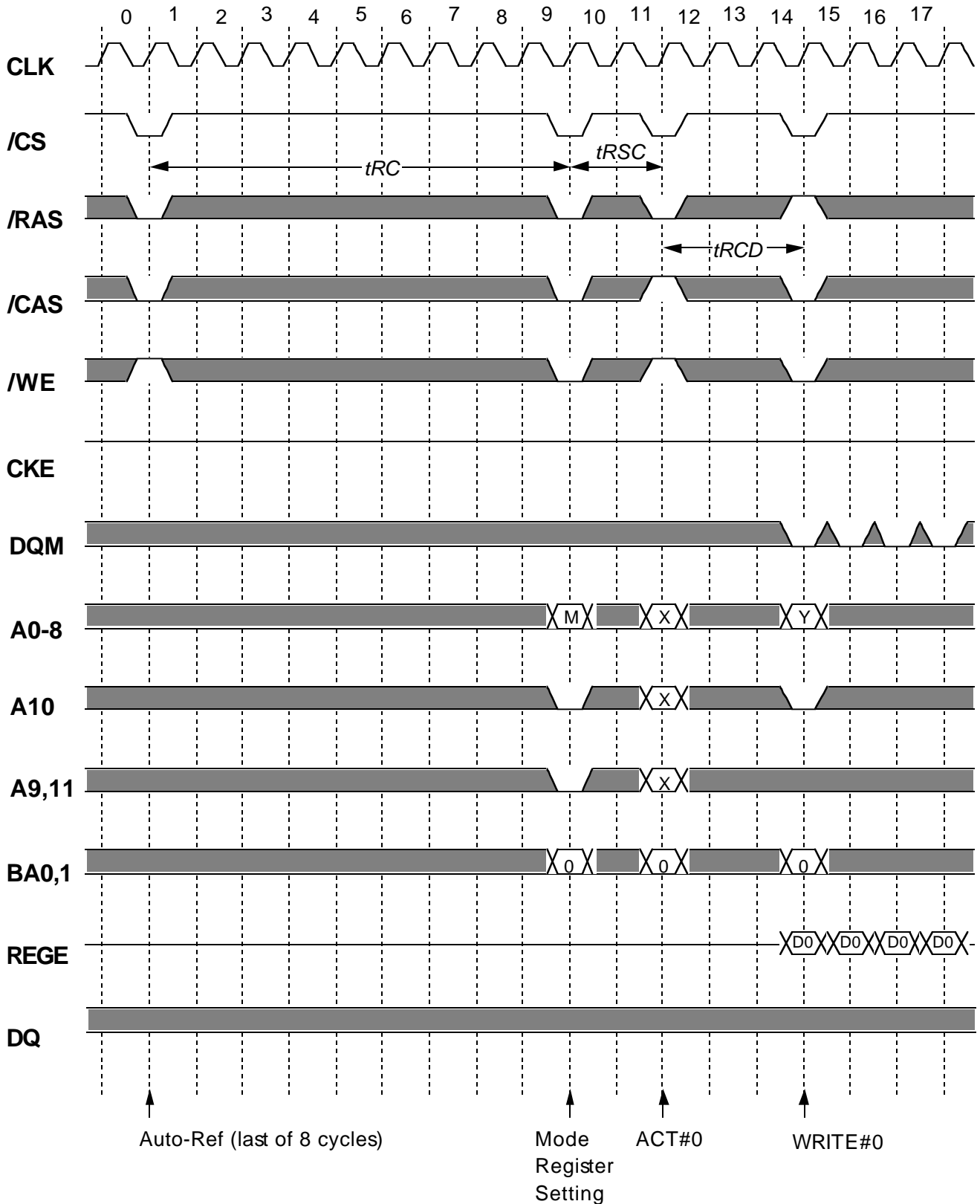

Italic parameter indicates minimum case

MH64S72QJA -7,-8

4,831,838,208-BIT (67,108,864-WORD BY 72-BIT) Synchronous DYNAMIC RAM

Auto-Refresh @BL=4

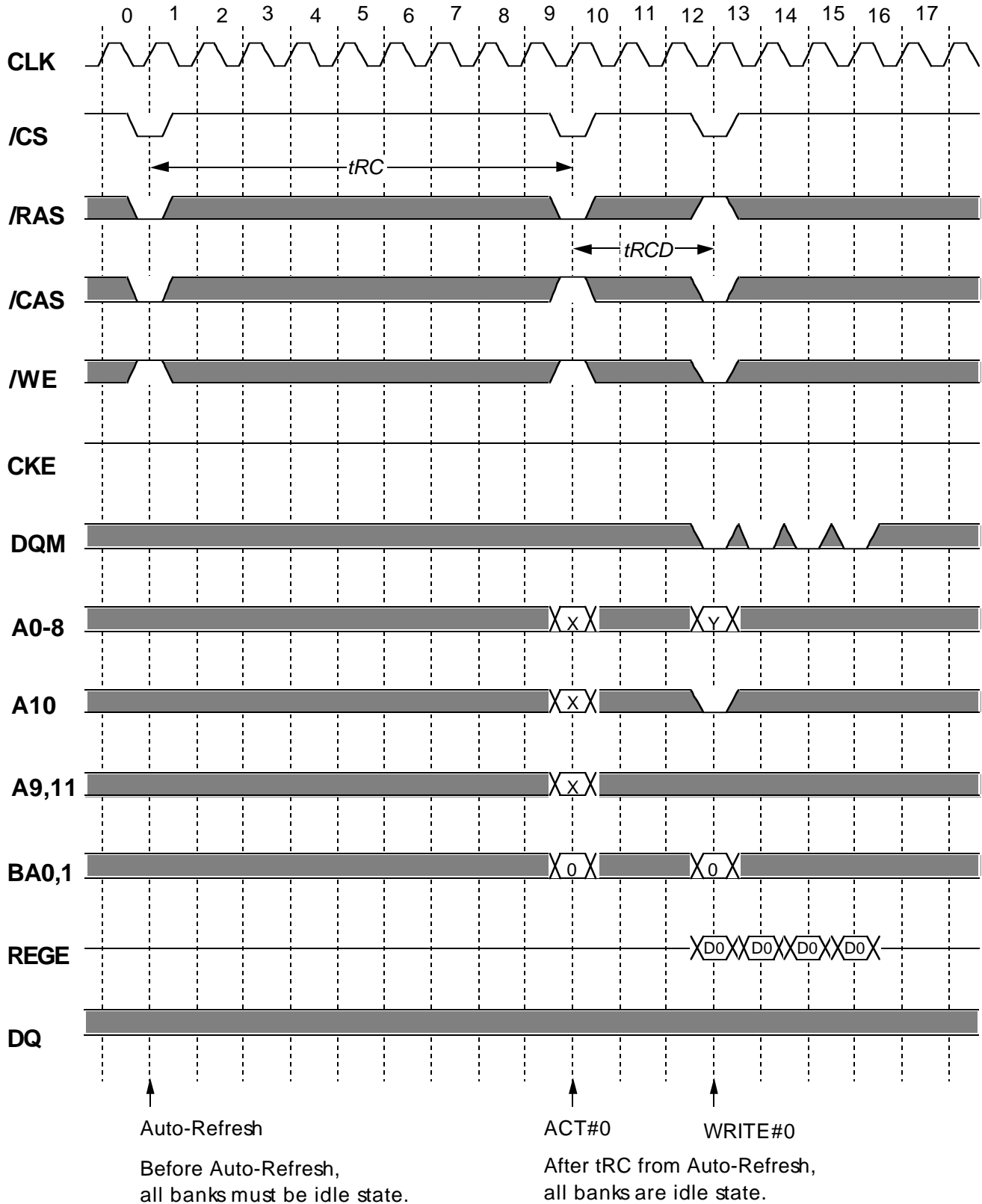

Italic parameter indicates minimum case

MH64S72QJA -7,-8

4,831,838,208-BIT (67,108,864-WORD BY 72-BIT) Synchronous DYNAMIC RAM

Self-Refresh

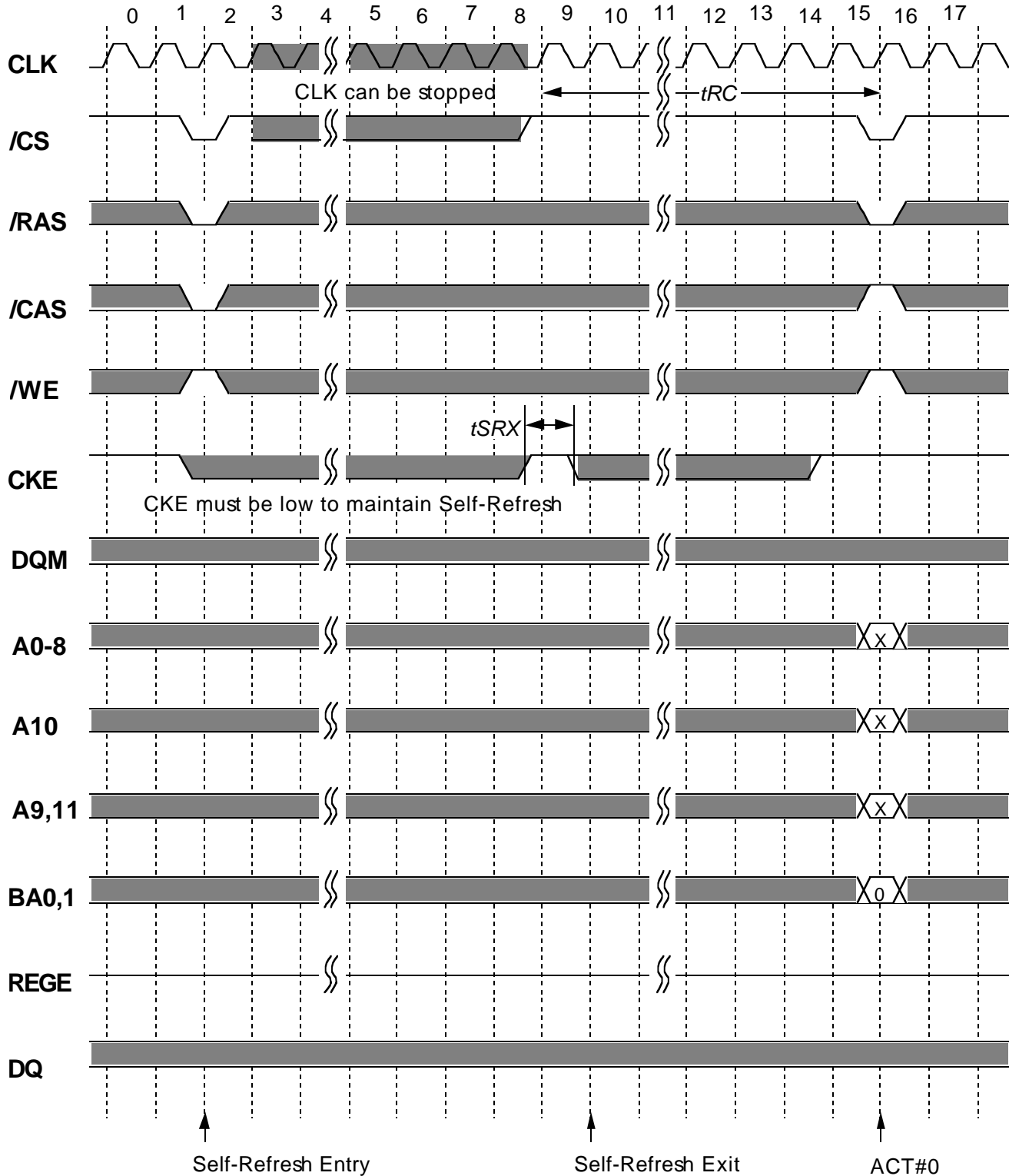

Before Self-Refresh Entry,
all banks must be idle state.

After t_{RC} from Self-Refresh Exit,
all banks are idle state.

Italic parameter indicates minimum case

Preliminary
Spec.

MH64S72QJA -7,-8

4,831,838,208-BIT (67,108,864-WORD BY 72-BIT) Synchronous DYNAMIC RAM

DQM Write Mask @BL=4

BL=4, Buffer mode (REGE="L")

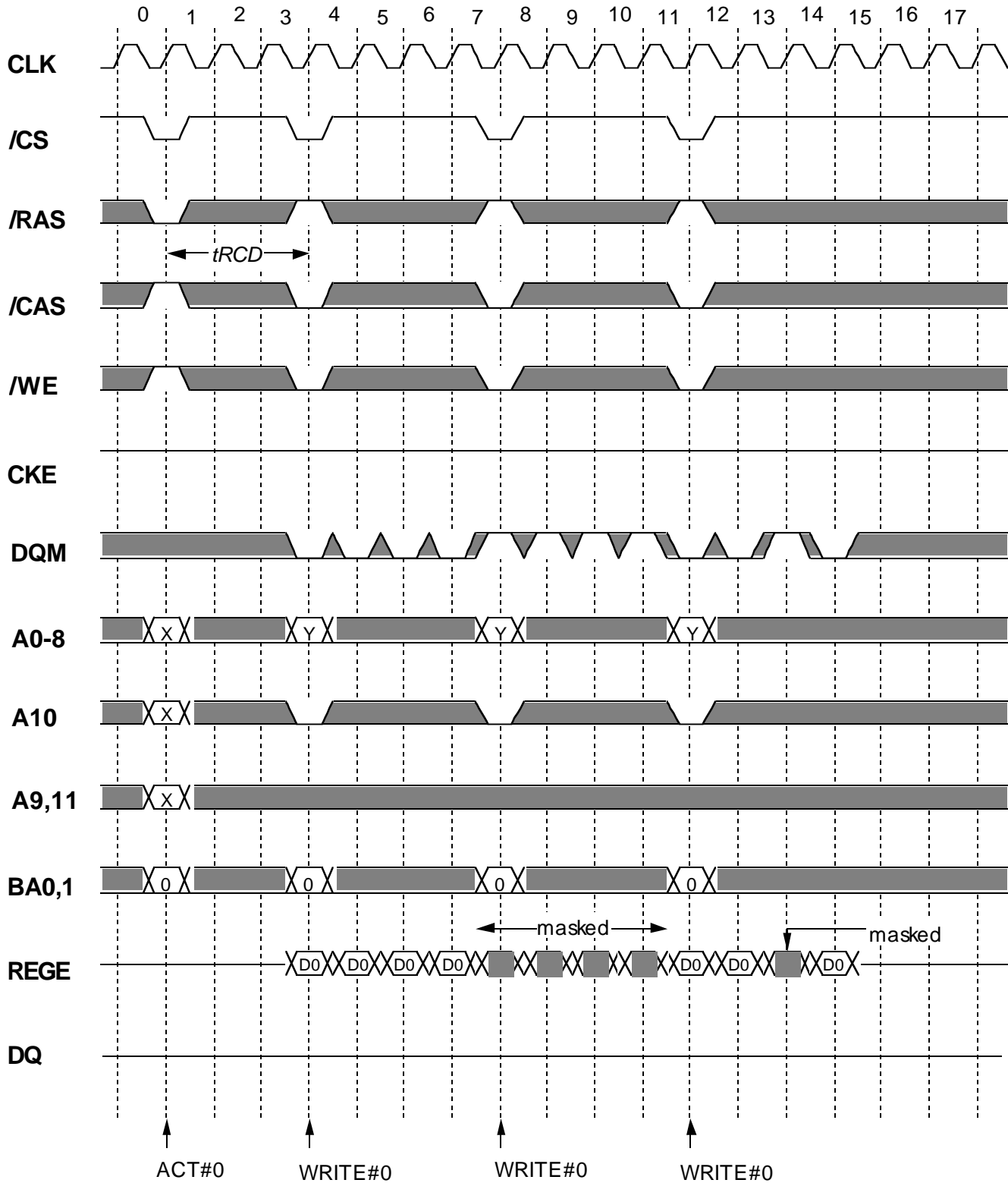

Italic parameter indicates minimum case

Preliminary
Spec.

MH64S72QJA -7,-8

4,831,838,208-BIT (67,108,864-WORD BY 72-BIT) Synchronous DYNAMIC RAM

DQM Write Mask @BL=4

BL=4, Latch mode (REGE="H")

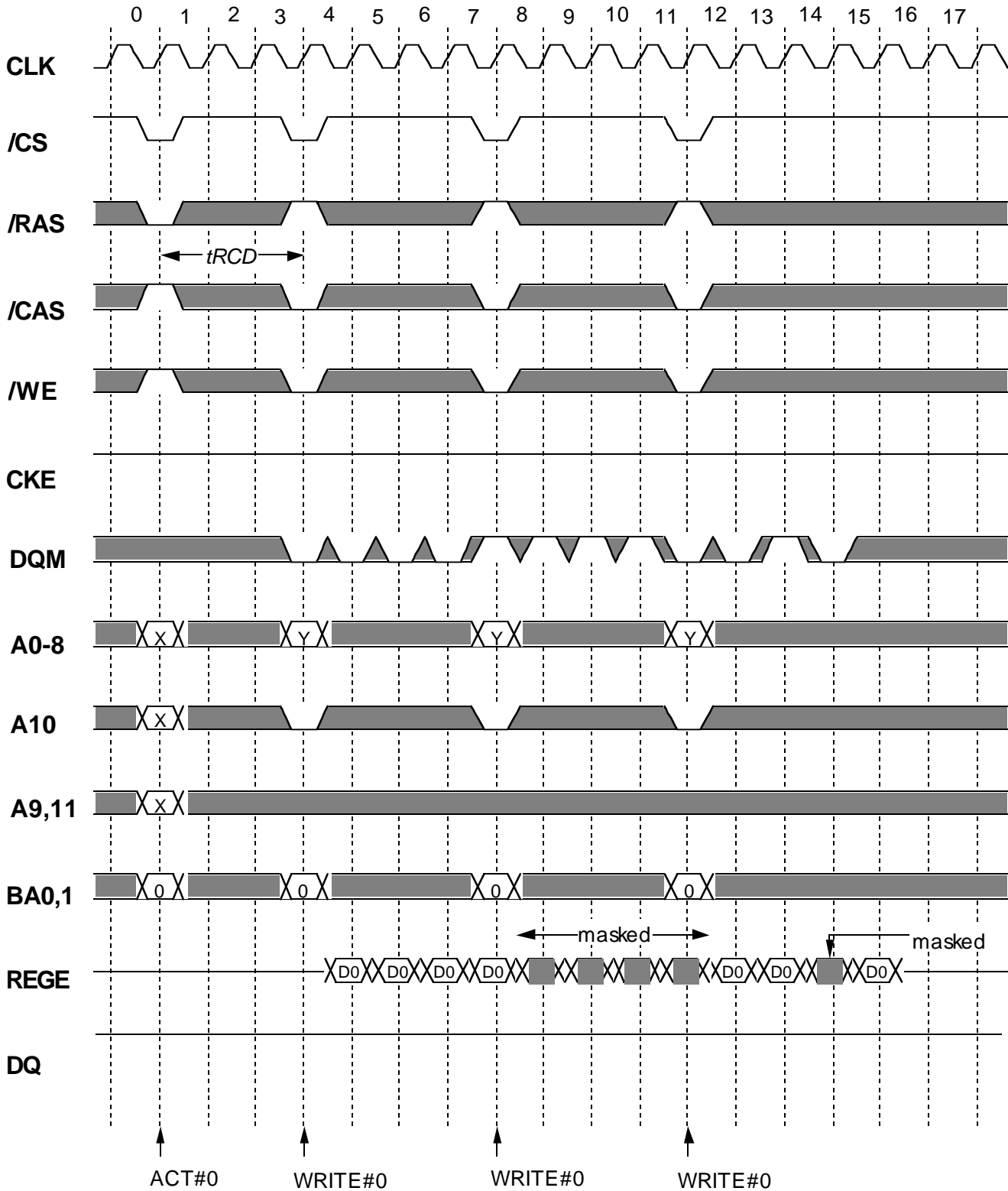

Italic parameter indicates minimum case

Preliminary
Spec.

MH64S72QJA -7,-8

4,831,838,208-BIT (67,108,864-WORD BY 72-BIT) Synchronous DYNAMIC RAM

DQM Read Mask @BL=4 CL=3

BL=4, Buffer mode(REGE="L")

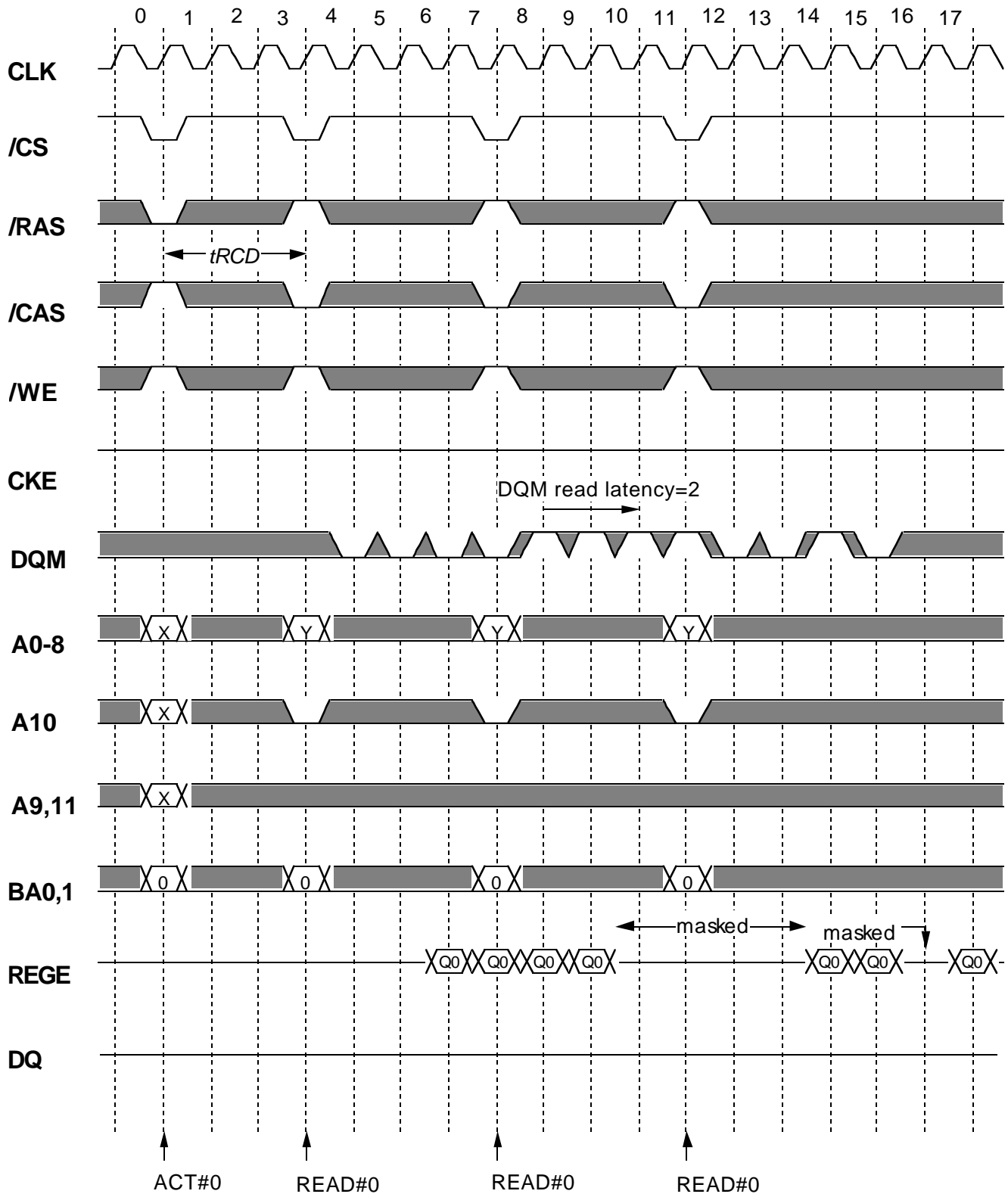

Italic parameter indicates minimum case

Preliminary
Spec.

MITSUBISHI LSIs

MH64S72QJA -7,-8

4,831,838,208-BIT (67,108,864-WORD BY 72-BIT) Synchronous DYNAMIC RAM

DQM Read Mask @BL=4 CL=3

BL=4,Latch mode(REGE="H")

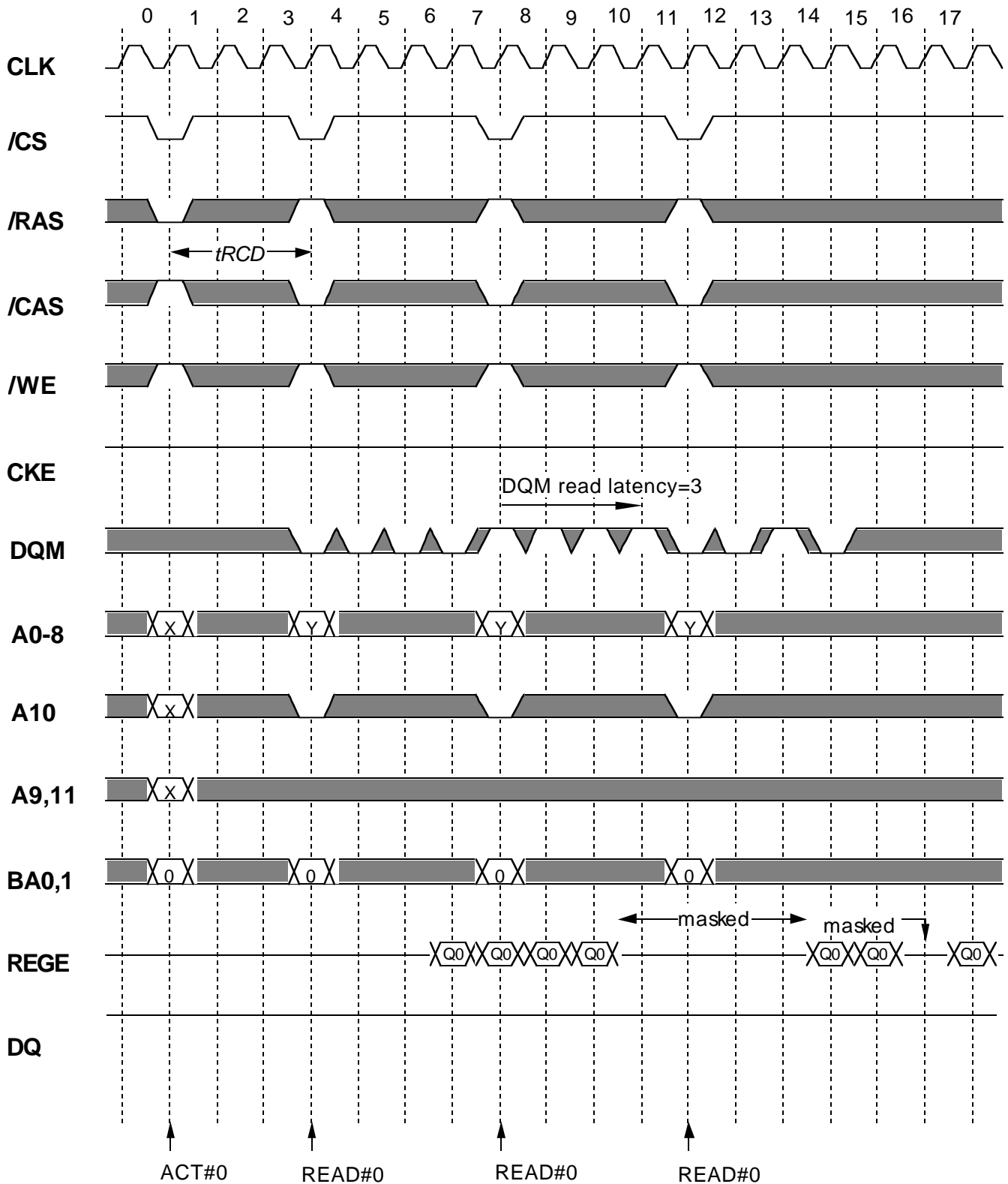

Italic parameter indicates minimum case

MH64S72QJA -7,-8

4,831,838,208-BIT (67,108,864-WORD BY 72-BIT) Synchronous DYNAMIC RAM

Power Down

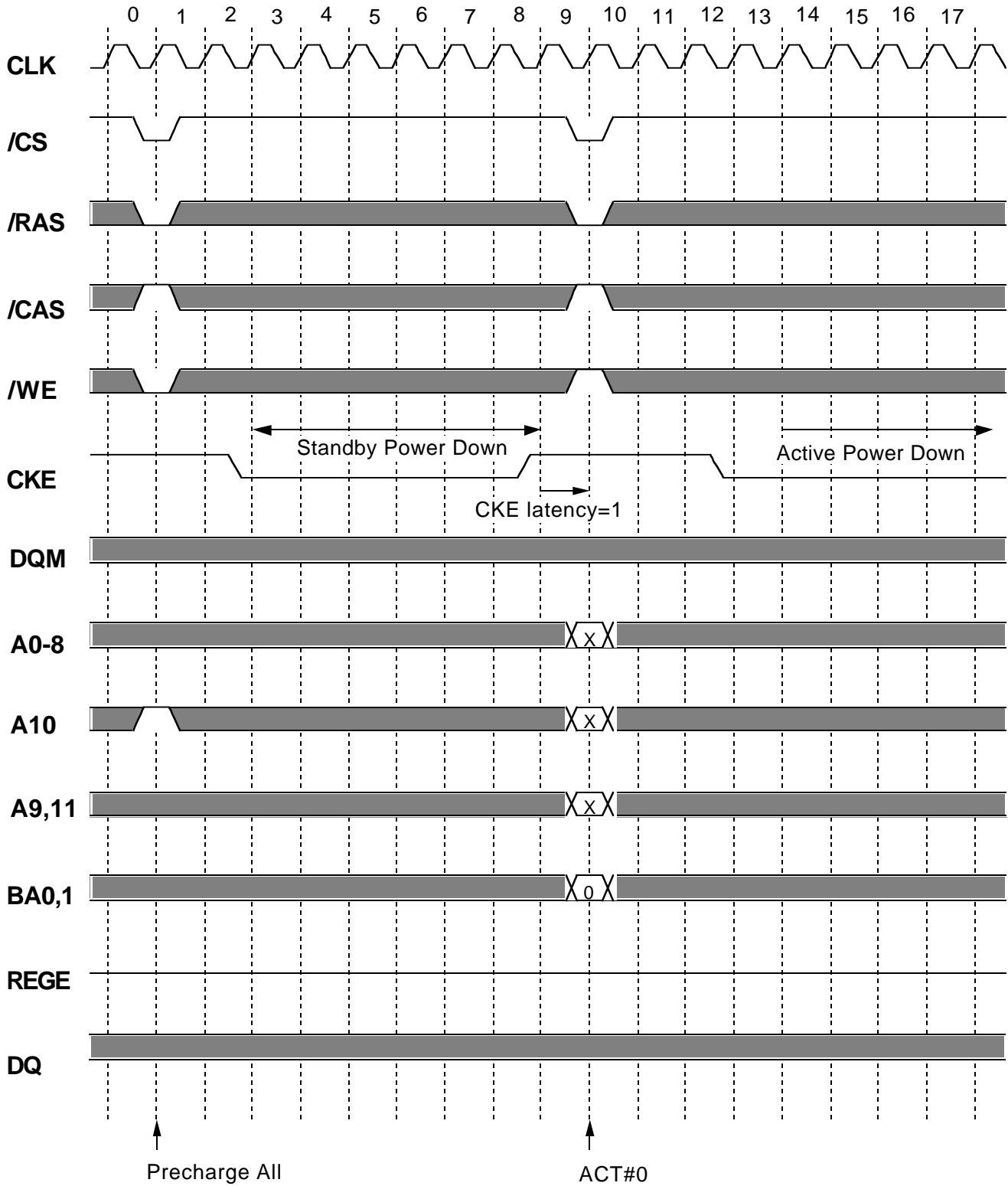

Italic parameter indicates minimum case

MH64S72QJA -7,-8

4,831,838,208-BIT (67,108,864-WORD BY 72-BIT) Synchronous DYNAMIC RAM

CLK Suspend @BL=4 CL=3

BL=4, Buffer mode (REGE="L")

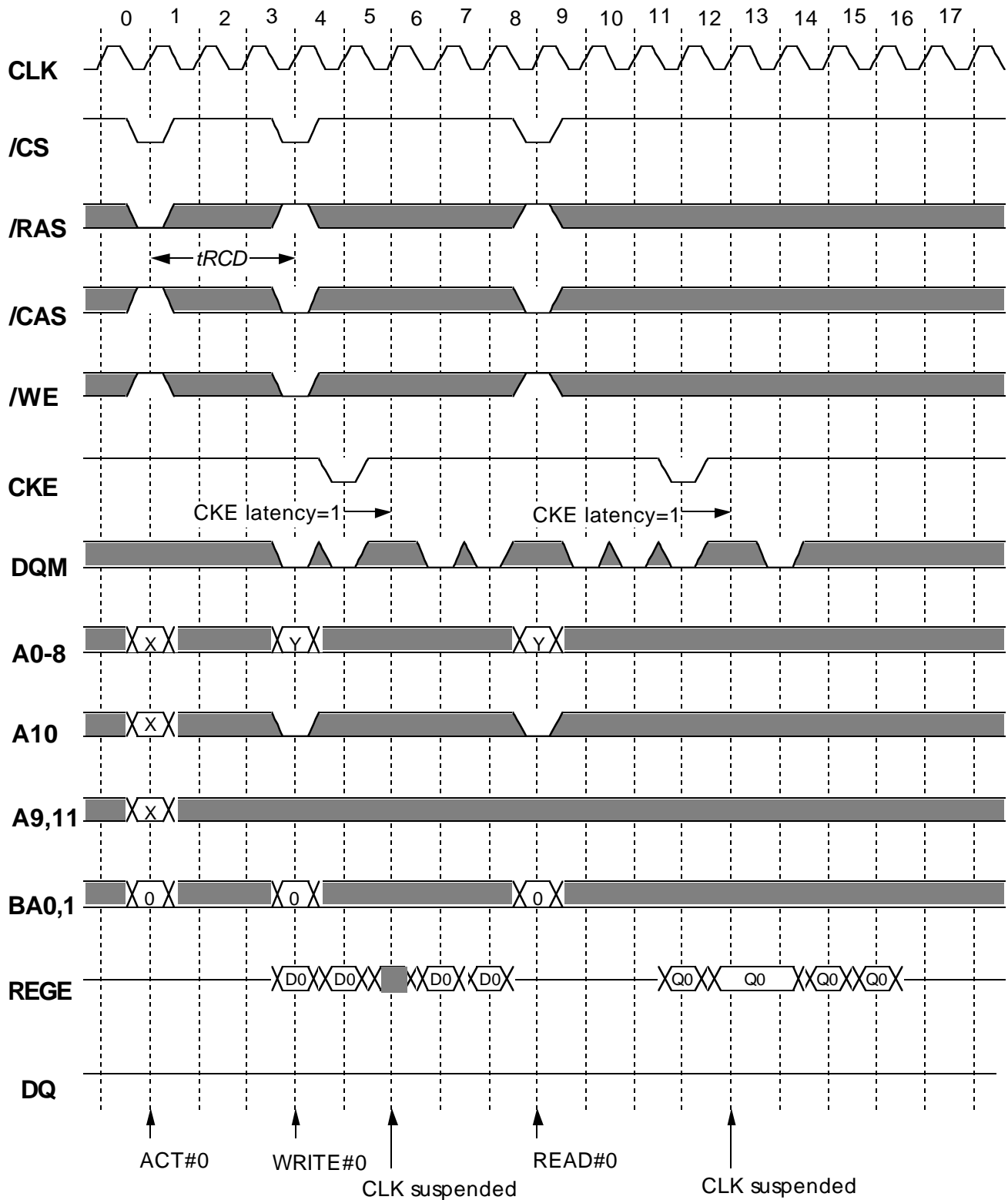

Italic parameter indicates minimum case

Preliminary
Spec.

MITSUBISHI LSIs

MH64S72QJA -7,-8

4,831,838,208-BIT (67,108,864-WORD BY 72-BIT) Synchronous DYNAMIC RAM

CLK Suspend @BL=4 CL=3

BL=4,Latch mode(REGE="H")

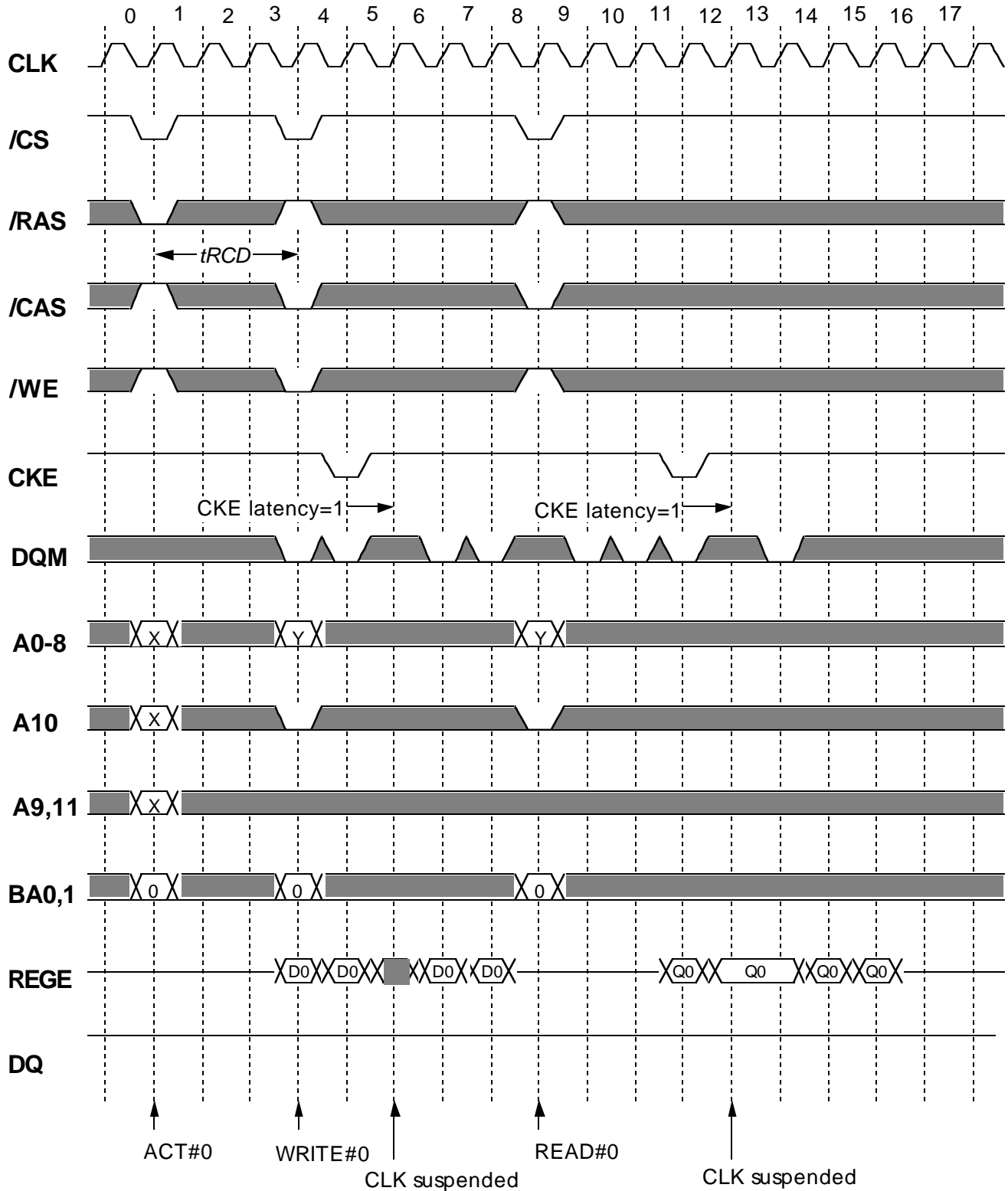

Italic parameter indicates minimum case

Preliminary
Spec.

MITSUBISHI LSIs

MH64S72QJA -7,-8

4,831,838,208-BIT (67,108,864-WORD BY 72-BIT) Synchronous DYNAMIC RAM

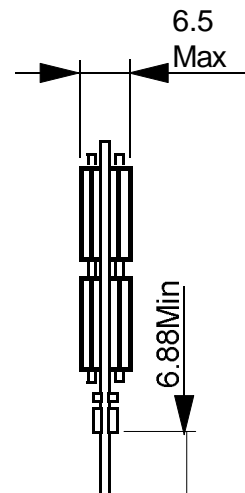
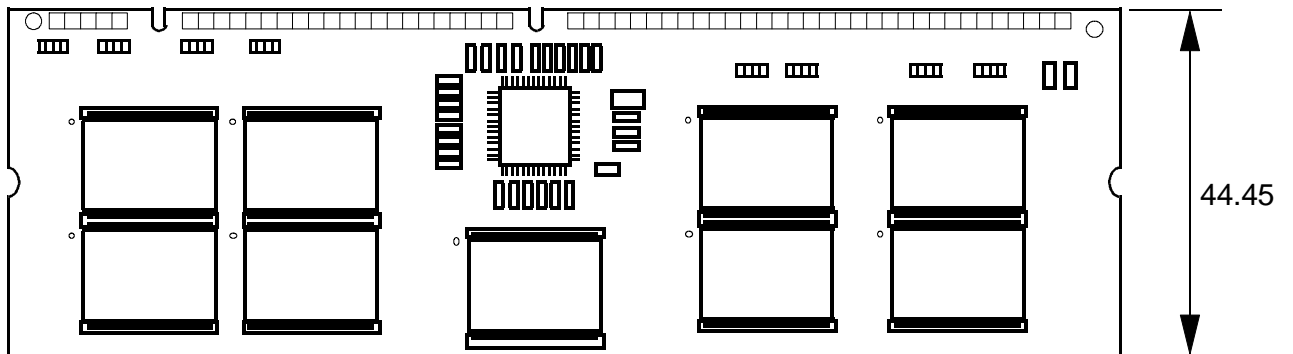
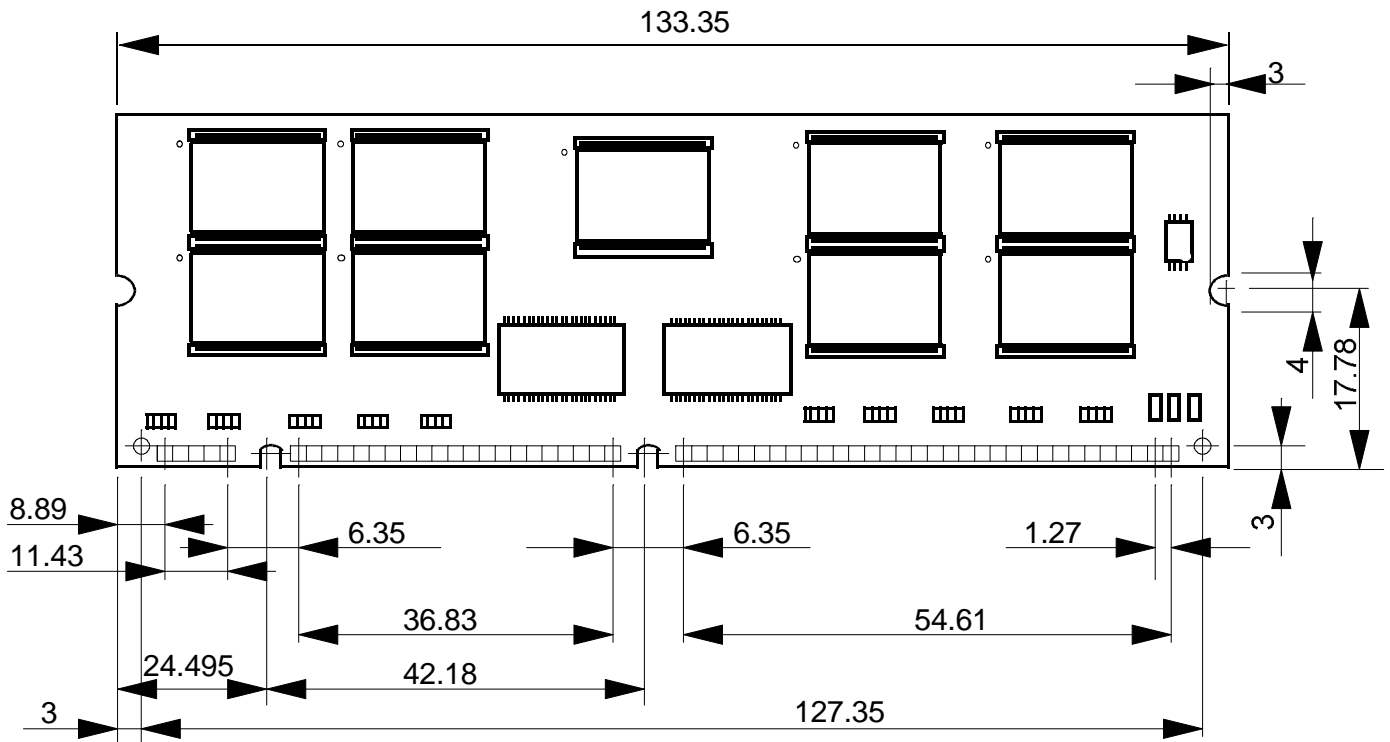

MH64S72QJA -7,-8

4,831,838,208-BIT (67,108,864-WORD BY 72-BIT) Synchronous DYNAMIC RAM

Keep safety first in your circuit designs!

Mitsubishi Electric Corporation puts the maximum effort into making semiconductor products better and more reliable, but there is always the possibility that trouble may occur with them. Trouble with semiconductors consideration to safety when making your circuit designs, with appropriate measures such as (i) placement of substitutive, auxiliary circuits, (ii) use of non-flammable material or (iii) prevention against any malfunction or mishap.

Notes regarding these materials

1. These materials are intended as a reference to assist our customers in the selection of the Mitsubishi semiconductor product best suited to the customer's application; they do not convey any license under any intellectual property rights, or any other rights, belonging to Mitsubishi Electric Corporation or a third party.
2. Mitsubishi Electric Corporation assumes no responsibility for any damage, or infringement of any third-party's rights, originating in the use of any product data, diagrams, charts or circuit application examples contained in these materials.
3. All information contained in these materials, including product data, diagrams and charts, represent information on products at the time of publication of these materials, and are subject to change by Mitsubishi Electric Corporation without notice due to product improvements or other reasons. It is therefore recommended that customers contact Mitsubishi Electric Corporation or an authorized Mitsubishi Semiconductor product distributor for the latest product information before purchasing a product listed herein.
4. Mitsubishi Electric Corporation semiconductors are not designed or manufactured for use in a device or system that is used under circumstances in which human life is potentially at stake. Please contact Mitsubishi Electric Corporation or an authorized Mitsubishi Semiconductor product distributor when considering the use of a product contained herein for special applications, such as apparatus or systems for transportation, vehicular, medical, aerospace, nuclear, or undersea repeater use.
5. The prior written approval of Mitsubishi Electric Corporation is necessary to reprint or reproduce in whole or in part these materials.
6. If these products or technologies are subject to the Japanese export control restrictions, they must be exported under a license from the Japanese government and cannot be imported into a country other than the approved destination.
Any diversion or reexport contrary to the export control laws and regulations of Japan and/or the country of destination is prohibited.
7. Please contact Mitsubishi Electric Corporation or an authorized Mitsubishi Semiconductor product distributor for further details on these materials or the products contained therein.