

# BIF1

## 5-800 MHz Internally Matched IF Amplifier



### Device Features

- OIP3 = 44.0 dBm @ 70 MHz
- Gain = 15.2 dB @ 70 MHz
- Output P1 dB = 20.0 dBm @ 70 MHz
- 50 Ω Cascadable
- Patented temperature compensation
- Patented over voltage protection
- Lead-free/RoHS-compliant SOT-89 SMT package



### Product Description

BeRex's BIF1 is a high performance InGaP/ GaAs HBT MMIC amplifier, internally matched to 50 Ohms and uses a patented **temperature compensation** circuit to provide stable current over the operating temperature range without the need for external components and a patented **over voltage protection** circuit to protect a internal device. The BIF1 is designed for high linearity IF amplifier that requires excellent gain, high OIP3 and flatness. It is packaged in a RoHS-compliant with SOT-89 surface mount package.

### Applications

- Base station Infrastructure/RFID
- Commercial/Industrial/Military wireless system

### Applications Circuit

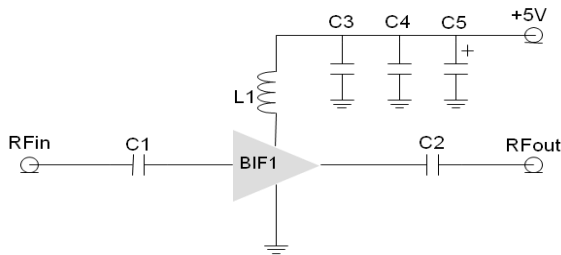

\*C1, C2=8200pF ± 5%; C3 = 100 pF ± 5%; C4 = 1000pF ±5%

\*C5 = 10uF; L1 = 1200nH ±5%

### Typical Performance<sup>1</sup>

Parameter	Frequency					Unit
	70	140	250	500	800	
Gain	15.2	15.2	15.1	15.0	14.7	dB
S11	-18.0	-18.0	-18.0	-18.0	-19.0	dB
S22	-16.0	-17.0	-16.0	-15.0	-13.0	dB
OIP3 <sup>2</sup>	44.0	42.0	40.5	40.0	37.5	dBm
P1dB	20.0	20.8	20.9	21.0	20.7	dBm
Noise Figure	4.2	4.3	4.3	4.4	4.5	dB

<sup>1</sup> Device performance \_ measured on a BeRex evaluation board at 25°C, 50 Ω system.

<sup>2</sup> OIP3 \_ measured with two tones at an output of 10 dBm per tone separated by 1 MHz.

	Min.	Typical	Max.	Unit
Bandwidth	5		800	MHz
I <sub>c</sub> @ (V <sub>c</sub> = 5V)	95	105	115	mA
V <sub>c</sub>		5.0		V
dG/dT		-0.001		dB/°C
R <sub>TH</sub>		50		°C/W

### Absolute Maximum Ratings

Parameter	Rating	Unit
Operating Case Temperature	-40 to +85	°C
Storage Temperature	-55 to +155	°C
Junction Temperature	+220	°C
Operating Voltage	+7.0	V
Supply Current	180	mA
Input RF Power	23	dBm

Operation of this device above any of these parameters may result in permanent damage.

Above 7V, a device goes to protection mode.

# BIF1

## 5-800 MHz Internally Matched IF Amplifier



### V-I Characteristics

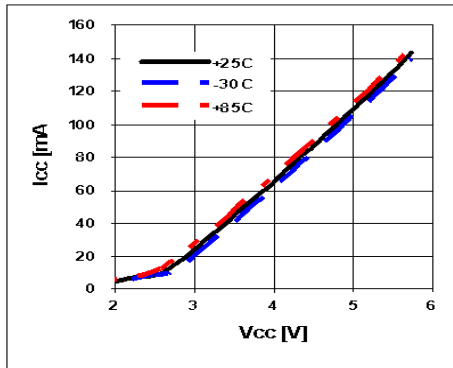

### BeRex SOT89 Evaluation Board

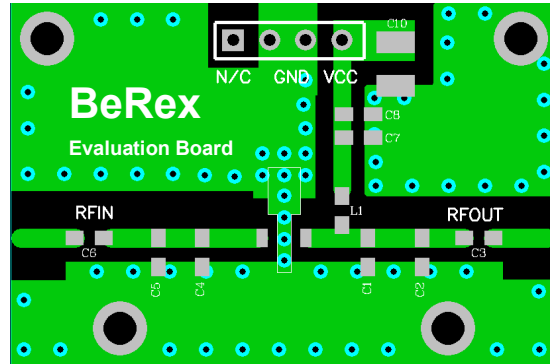

\*Dielectric constant \_ 4.2 \*RF pattern width 52mil \*31mil thick FR4 PCB

### Typical Device Data

S-parameters (Vc=5V, Ic=105mA, T=25°C)

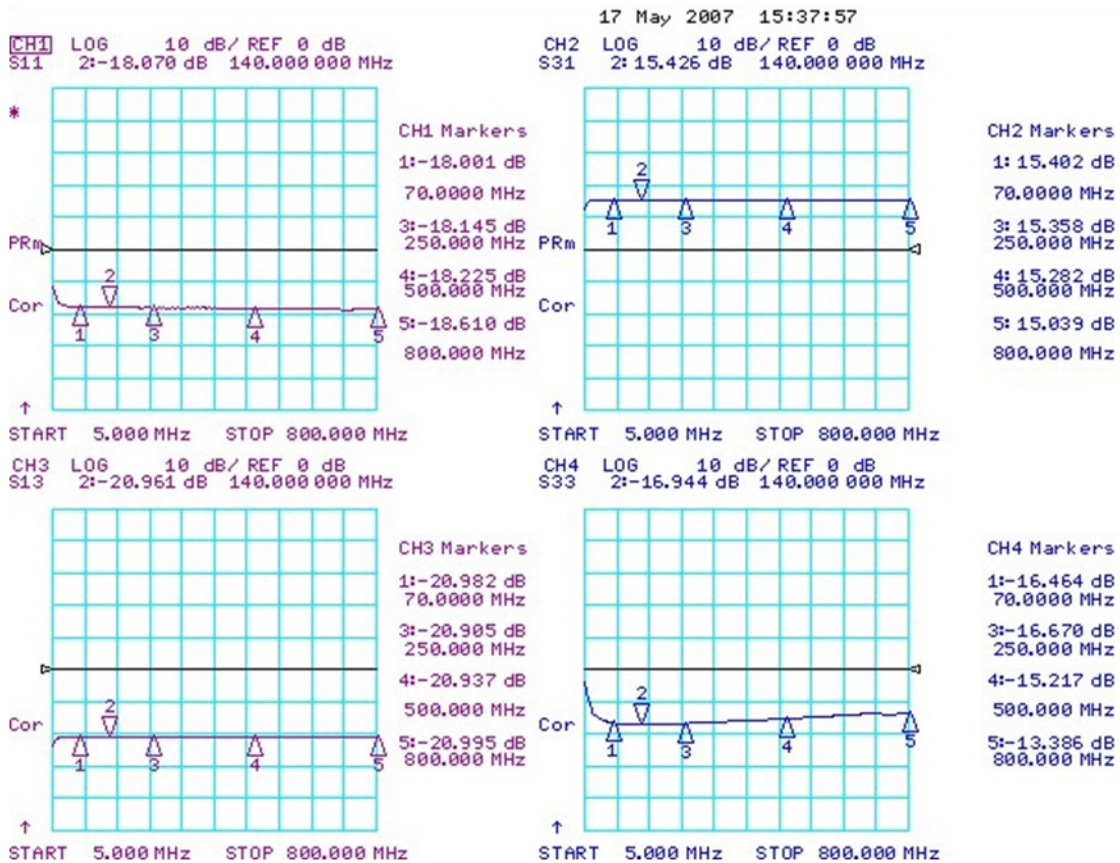



## 5-800 MHz Internally Matched IF Amplifier

### S-Parameter

(V<sub>device</sub> = 5.0V, I<sub>cc</sub> = 105mA, T = 25 °C, calibrated to device leads)

Freq [MHz]	S11 [Mag]	S11 [Ang]	S21 [Mag]	S21 [Ang]	S12 [Mag]	S12 [Ang]	S22 [Mag]	S22 [Ang]
100	0.617	175.8	6.221	176.0	0.086	0.1	0.136	-11.0
500	0.610	158.6	5.549	161.5	0.094	-2.4	0.152	-58.7
1000	0.585	139.9	5.456	147.9	0.086	-4.0	0.194	-101.8
1500	0.567	121.9	5.193	134.2	0.093	-1.6	0.252	-138.3
2000	0.477	103.1	5.197	121.3	0.089	-10.2	0.294	-168.7
2500	0.450	87.8	5.296	111.9	0.089	-5.6	0.354	163.7
3000	0.408	69.5	6.415	94.6	0.094	-11.4	0.429	134.2
3500	0.368	59.9	6.356	71.1	0.091	-11.4	0.495	112.2
4000	0.381	44.8	6.220	50.3	0.101	-17.7	0.554	82.2

Typical Performance (V<sub>d</sub> = 5V, I<sub>c</sub> = 108mA, T = 25°C)

Freq	MHz	70	140	250	500	800
S21	dB	15.2	15.2	15.1	15.0	14.7
S11	dB	-18	-18	-18	-18	-19
S22	dB	-16	-17	-16	-15	-13
P1	dBm	20.0	20.8	20.9	21.0	20.7
OIP3	dBm	44.0	42.0	40.5	40.0	37.5
NF	dB	4.2	4.3	4.3	4.4	4.5

Typical Performance (V<sub>d</sub> = 4.7V, I<sub>c</sub> = 87mA, T = 25°C)

Freq	MHz	70	140	250	500	800
S21	dB	15.2	15.2	15.1	15	14.8
S11	dB	-18.6	-20.4	-21.6	-23.3	-25.6
S22	dB	-11.9	-14.6	-15.6	-14.1	-10.9
P1	dBm	18.9	19.5	19.4	19.8	19.3
OIP3	dBm	42.5	38.5	41	38	34.9
NF	dB	4.2	4.3	4.3	4.4	4.5

Typical Performance (V<sub>d</sub> = 4.5V, I<sub>c</sub> = 79mA, T = 25°C)

Freq	MHz	70	140	250	500	800
S21	dB	15.1	15.1	15.0	14.9	14.9
S11	dB	-18.7	-20.7	-22	-23.8	-26.1
S22	dB	-11.8	-14.5	-15.4	-14	-10.8
P1	dBm	18.6	19.3	19.4	19.3	19.4
OIP3	dBm	42.4	42.0	38.0	38.0	36.0
NF	dB	4.2	4.3	4.3	4.4	4.5

# BIF1



## 5-800 MHz Internally Matched IF Amplifier

---

Typical Performance (Vd = 4V, Ic = 60mA, T = 25°C)

Freq	MHz	70	140	250	500	800
S21	dB	15	15.1	15	14.8	14.6
S11	dB	-19.4	-21.8	-23.4	-25.5	-28
S22	dB	-11.7	-14.2	-15.1	-13.7	-10.6
P1	dBm	16.4	16.9	17	16.9	16.7
OIP3	dBm	37.5	35.5	36.5	34.5	32.2
NF	dB	4.2	4.3	4.3	4.4	4.5

Typical Performance (Vd = 3.5V, Ic = 40mA, T = 25°C)

Freq	MHz	70	140	250	500	800
S21	dB	14.8	14.9	14.8	14.6	14.4
S11	dB	-20.7	-24.4	-26.9	-30	-32.1
S22	dB	-11.4	-13.6	-14.4	-13.1	-10.2
P1	dBm	13.4	14.1	14.2	13.6	13.3
OIP3	dBm	34	31.5	30.5	29.5	28.6
NF	dB	4.2	4.3	4.3	4.4	4.5

# BIF1

## 5-800 MHz Internally Matched IF Amplifier



### Device Performance

#### OIP3

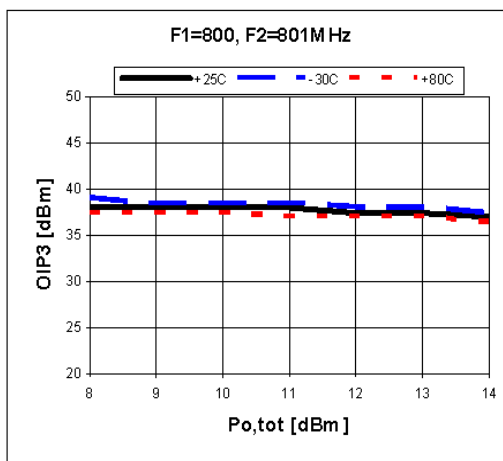
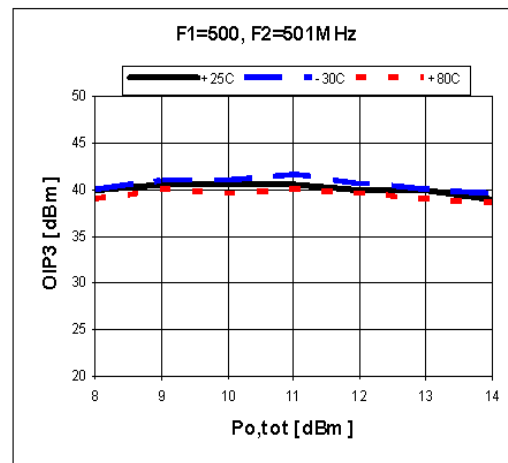
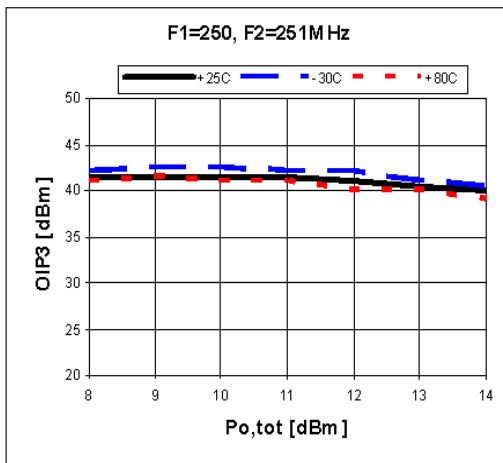
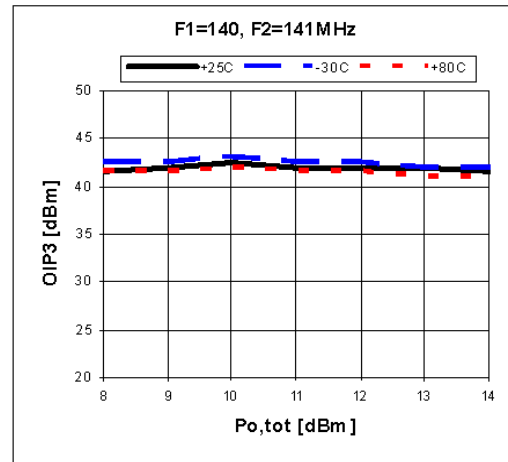
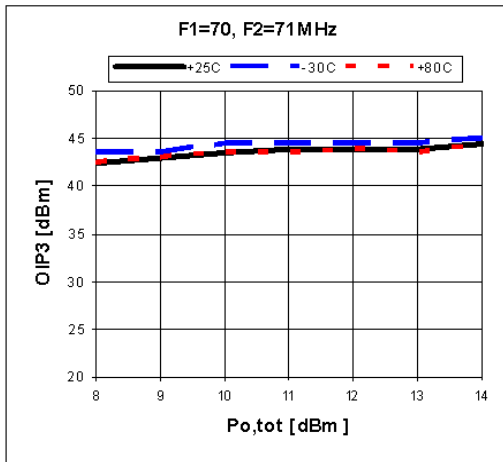

# BIF1

## 5-800 MHz Internally Matched IF Amplifier



### ACPR

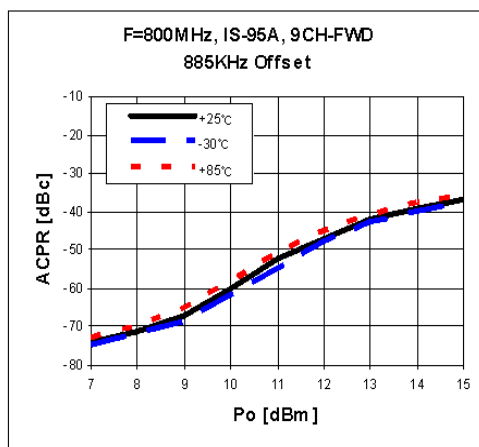
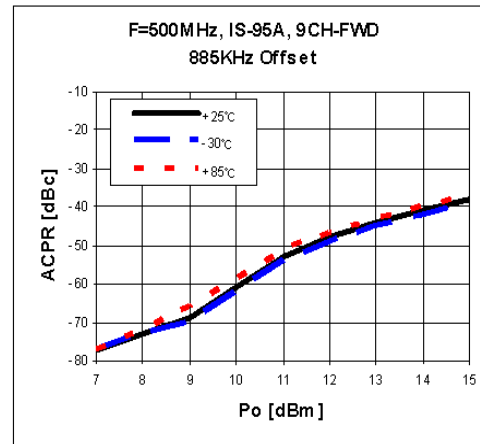
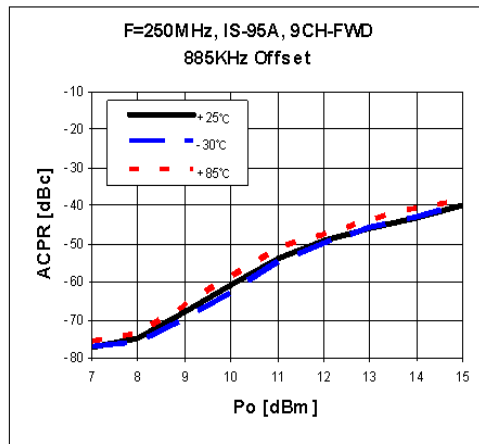
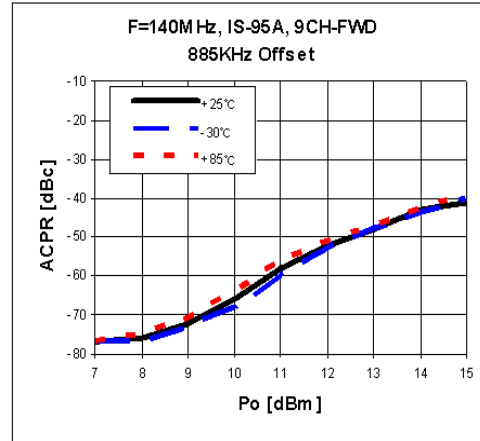
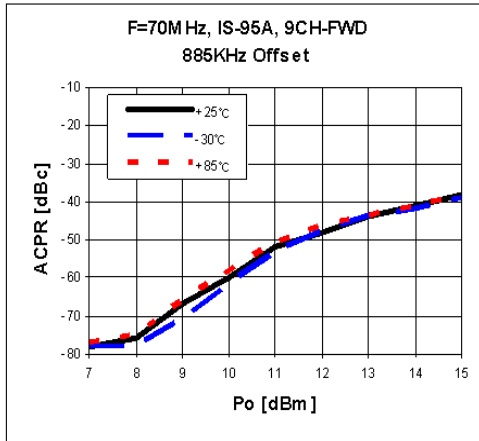

# BIF1



## 5-800 MHz Internally Matched IF Amplifier

### ACLR

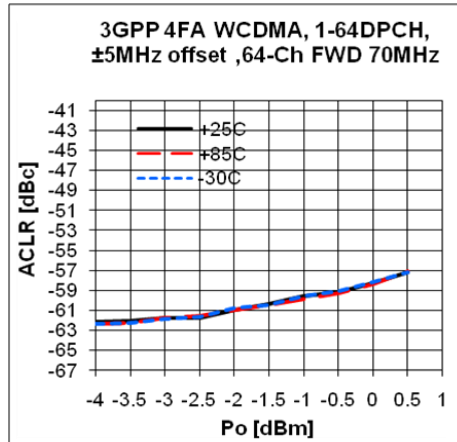

### S-Parameters(S11/S22)

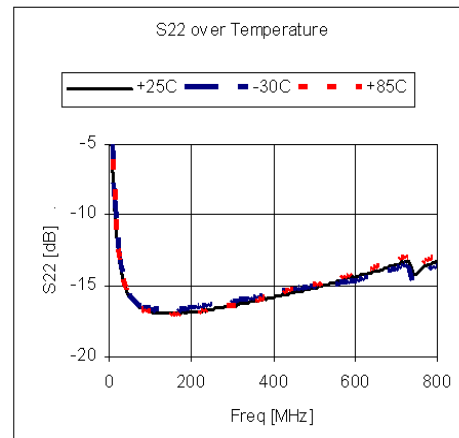
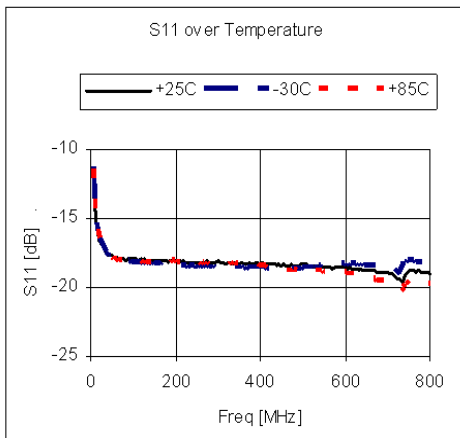

### Gain Flatness

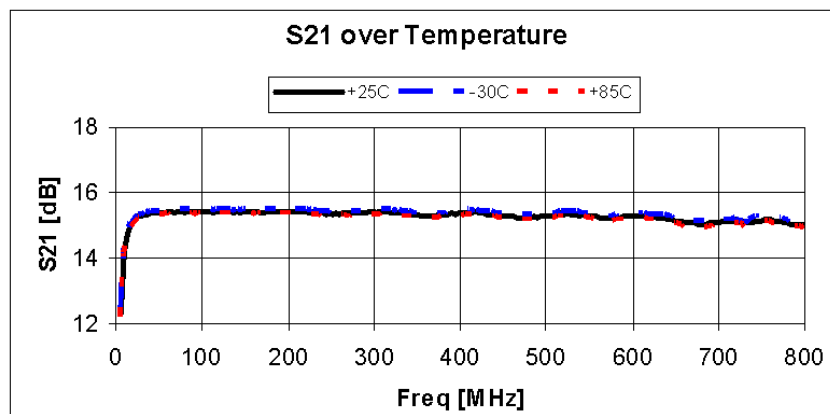

# BIF1

## 5-800 MHz Internally Matched IF Amplifier



### Package Outline Dimension

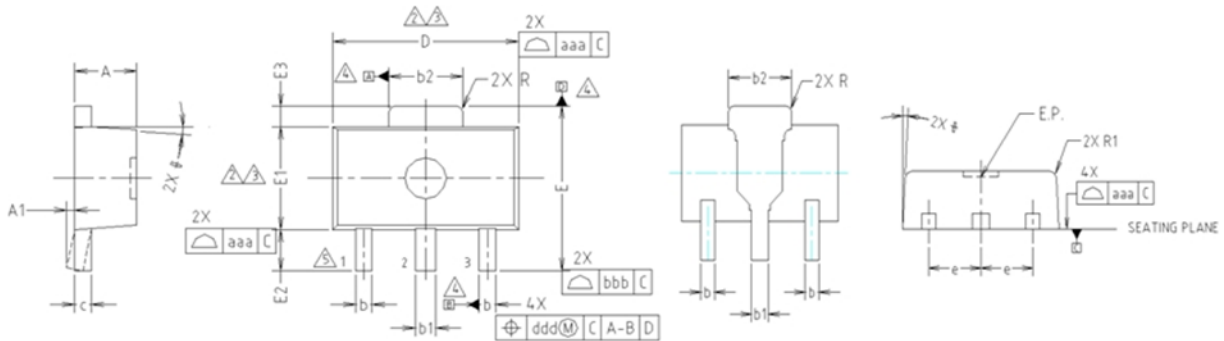

- NOTE:**  
 1. DIMENSIONS IN MILLIMETERS.
- ⚠ DIMENSION D DOES NOT INCLUDE MOLD FLASH, PROTRUSIONS OR GATE BURRS. MOLD FLASH, PROTRUSIONS OR GATE BURRS SHALL NOT EXCEED 0.5mm PER END. DIMENSION E1 DOES NOT INCLUDE INTERLEAD FLASH OR PROTRUSION. INTERLEAD FLASH OR PROTRUSION SHALL NOT EXCEED 0.5mm PER SIDE.
  - ⚠ DIMENSIONS D AND E1 ARE DETERMINED AT THE OUTMOST EXTREMES OF THE PLASTIC BODY EXCLUSIVE OF MOLD FLASH, TIE BAR BURRS, GATE BURRS AND INTERLEAD FLASH, BUT INCLUDING ANY MISMATCH BETWEEN THE TOP AND BOTTOM OF THE PLASTIC BODY.
  - ⚠ DATUMS A, B AND D TO BE DETERMINED 0.18mm FROM THE LEAD TIP.
  - ⚠ TERMINAL NUMBERS ARE SHOWN FOR REFERENCE ONLY.

SYMBOL	MILLIMETERS			NOTE
	MINIMUM	NOMINAL	MAXIMUM	
A	1.40	1.50	1.60	
A1	0.00	—	0.10	
b	0.38	0.42	0.48	
b1	0.48	0.52	0.58	
b2	1.79	1.82	1.87	
c	0.40	0.42	0.46	
D	4.40	4.50	4.70	2,3
E	3.70	4.00	4.30	
E1	2.40	2.50	2.70	2,3
E2	0.80	1.00	1.20	
E3	0.40	0.50	0.60	
e	1.50 TYP.			
φ	4° TYP.			
R	0.15 TYP.			
R1	—	—	0.20	
SYMBOL	TOLERANCES OF FORM AND POSITION		NOTE	
aaa	0.15			
bbb	0.20			
ccc	0.10			
ddd	0.10			

### Suggested PCB Land Pattern and PAD Layout

PCB Land Pattern

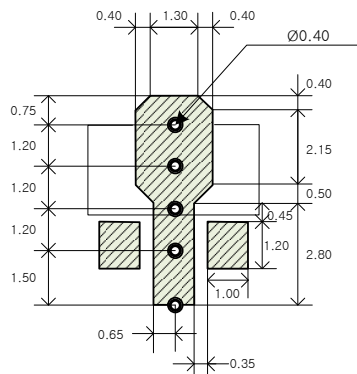

Note : All dimension \_ millimeters

PCB lay out \_ on BeRex website

PCB Mounting

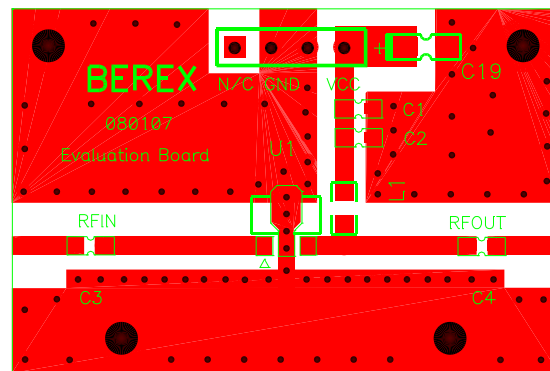



# BIF1

5-800 MHz Internally Matched IF Amplifier



## Tape & Reel

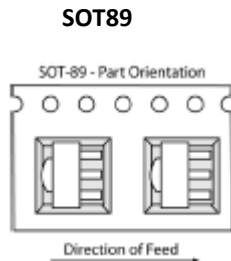

Packaging information:

Tape Width (mm): 12

Reel Size (inches): 7

Device Cavity Pitch (mm): 8

Devices Per Reel: 1000

## Lead plating finish

100% Tin Matte finish

(All BeRex products undergoes a 1 hour, 150 degree C, Anneal bake to eliminate thin whisker growth concerns.)

## MSL / ESD Rating

<b>ESD Rating:</b>	Class 1C
<b>Value:</b>	<b>Passes &lt;2000V</b>
<b>Test:</b>	Human Body Model (HBM)
<b>Standard:</b>	JEDEC Standard JESD22-A114B
<b>MSL Rating:</b>	<b>Level 1 at +265°C convection reflow</b>
<b>Standard:</b>	JEDEC Standard J-STD-020

## NATO CAGE code:

2	N	9	6	F
---	---	---	---	---