

PWM Control 3A Step-Down Converter

❖ GENERAL DESCRIPTION

AX3112 consists of step-down switching regulator with PWM control. The device includes a reference voltage source, oscillation circuit, error amplifier, internal PMOS and etc.

AX3112 provides low-ripple power, high efficiency, and excellent transient characteristics. The PWM control circuit is able to the duty ratio linearly forms 0 up to 100%. With the addition of an internal P-channel Power MOS, a coil, capacitors, and a diode connected externally, these ICs can function as step-down switching regulators. They serve as ideal power supply units for portable devices when coupled with the SOP-8L-EP package, providing such outstanding features as low current consumption. Since this converter can accommodate an input voltage up to 40V, it is also suitable for the operation via an AC adapter.

❖ FEATURES

- Input voltage : 8V to 40V
- Adjustable version output voltage range from 3.3V to 38V
- Duty ratio : 0% to 100% PWM control
- Oscillation frequency : 100K/350 KHz
- Enable and auto restart function.
- Thermal Shutdown function / Internal OVP.
- Short Circuit Protect (SCP).
- Built-in internal SW P-channel MOS.
- SOP-8L-EP Pb-Free package.

❖ BLOCK DIAGRAM

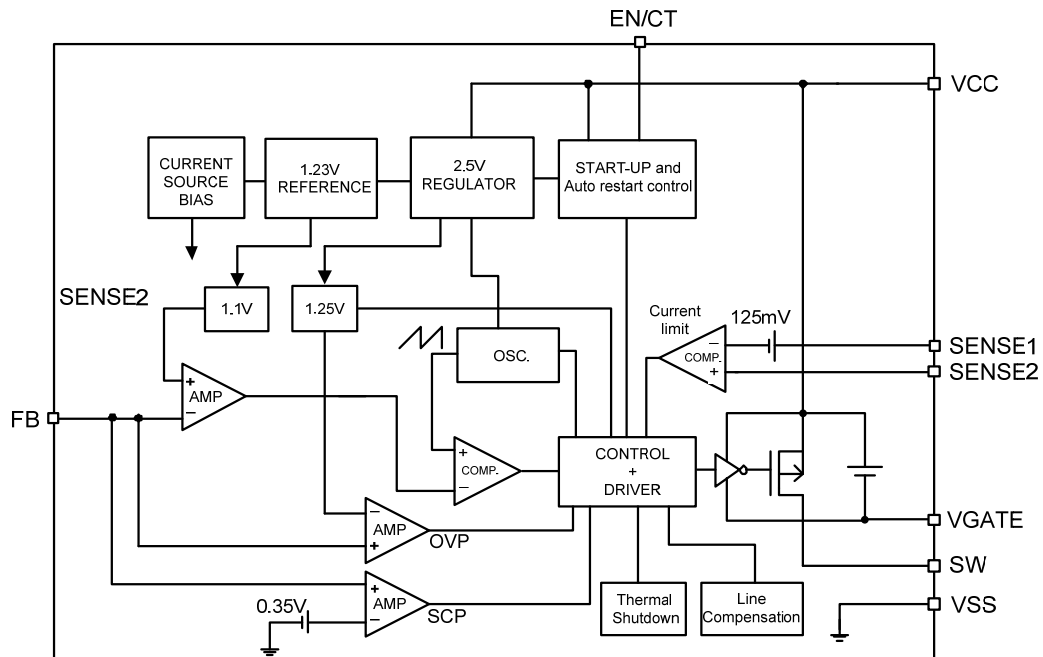

❖ PIN ASSIGNMENT

The package of AX3112 is SOP-8L-EP; the pin assignment is given by:

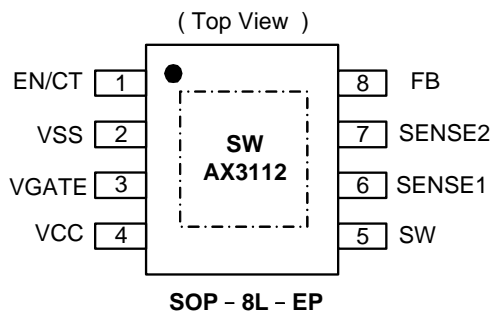

Name	Description
EN/CT	ON/OFF and auto restart control
VSS	GND pin
VGATE	Driver gate clamping pin. The pin must connect a 0.1uF capacitor to VCC
VCC	Operating voltage input
SW	Switch pin. Connect external inductor and diode here
SENSE1	Current sense input1
SENSE2	Current sense input2
FB	Feedback pin

❖ ORDER/MARKING INFORMATION

Order Information	Top Marking
<p>AX3112 X XX X</p> <p>Frequency: Blank : 100KHz, A: 350KHz Package Type: ES: SOP-8L-EP Packing: Blank : Tube, A : Taping</p>	<p>Logo ← AX3112 → Part number</p> <p> AYYWWX → ID code: internal</p> <p> WW: 01~52 Year: 10=2010, 11=2011</p> <p>Blank: AX3112 A: AX3112A</p>

❖ **ABSOLUTE MAXIMUM RATINGS** (at $T_A = 25^\circ\text{C}$)

Characteristics	Symbol	Rating	Unit
VCC Pin Voltage	V_{CC}	$V_{SS} - 0.3$ to $V_{SS} + 45$	V
Feedback Pin Voltage	V_{FB}	$V_{SS} - 0.3$ to 38	V
EN/CT, OVP Pin Voltage		$V_{SS} - 0.3$ to 6	V
SENSE1,SENSE2 Pin Voltage		$V_{SS} - 0.3$ to 38	V
Switch Pin Voltage	V_{SW}	$V_{SS} - 0.3$ to $V_{CC} + 0.3$	V
Power Dissipation	PD	$(T_J - T_A) / \theta_{JA}$	W
Storage Temperature Range	T_{ST}	-40 to +165	$^\circ\text{C}$
Operating Temperature Range	T_{OP}	-20 to +125	$^\circ\text{C}$
Operating Supply Voltage	V_{OP}	+8 to +40	V
Output Current	I_{OUT}	0 to 3	A
Thermal Resistance from Junction to case	θ_{JC}	15	$^\circ\text{C/W}$
Thermal Resistance from Junction to ambient	θ_{JA}	40	$^\circ\text{C/W}$

Note : θ_{JA} is measured with the PCB copper are (need connect to Exposed pad) of approximately 1 in²(Multi-layer).

❖ **ELECTRICAL CHARACTERISTICS** ($V_{CC}=12V$, $T_A=25^{\circ}C$, unless otherwise specified)

Characteristics	Symbol	Conditions	Min	Typ	Max	Units
FB	V_{FB}	$I_{OUT}=10mA$	1.08	1.10	1.12	V
Under Voltage Lockout	U_{VLO}	Falling	-	6	-	V
UVLO Hysteresis	-		-	0.8	-	V
OVP detect voltage	V_{OVP}	FB floating	-	1.250	-	V
Line Regulation	-	$V_{CC}=10 \sim 40V$	-	0.5	1	%
Load Regulation	-	$I_{OUT}=0 \sim 1A$, $R_{SENSE} = 140m\Omega$	-	0.3	0.6%	mV
Quiescent Current	I_{CCQ}	$V_{FB} > 1.2V$	-	3	6	mA
Oscillator frequency	F_{OSC}	AX3112	80	100	120	KHz
		AX3112A	280	350	420	
Max. Duty Cycle (ON)	DC	Force driver on $V_{FB} = 0.7V$	-	100	-	%
Min. Duty Cycle (OFF)		Force driver off $V_{FB} = 1.2V$	-	0	-	
Internal MOSFET $R_{DS(ON)}$	$R_{DS(ON)}$	$V_{CC}=12V$, $V_{FB} = 0.7V$	-	110	170	m Ω
Sense Voltage	V_{SENSE}	$V_{SENSE1}-V_{SENSE2}$	110	125	140	mV
Sense Voltage Hysteresis	$V_{SENSE-h}$		-	45	-	mV
EN/CT pin logic input threshold voltage	V_{EN}	Shutdown mode	-		0.3	V
	V_{CT}	Auto restart, $V_{FB}<0.4V$	0.5		1.5	
EN/CT pin current	$I_{EN/CT-C}$	Charge current	-	-32	-	μA
EN/CT pin current	$I_{EN/CT-D}$	Discharge current	-	1.5	-	μA
Thermal shutdown Temp	T_{SD}		-	160	-	$^{\circ}C$
Thermal Shutdown Hysteresis	T_{SH}		-	40	-	$^{\circ}C$

❖ APPLICATION CIRCUIT

(1) AL CAPACITOR

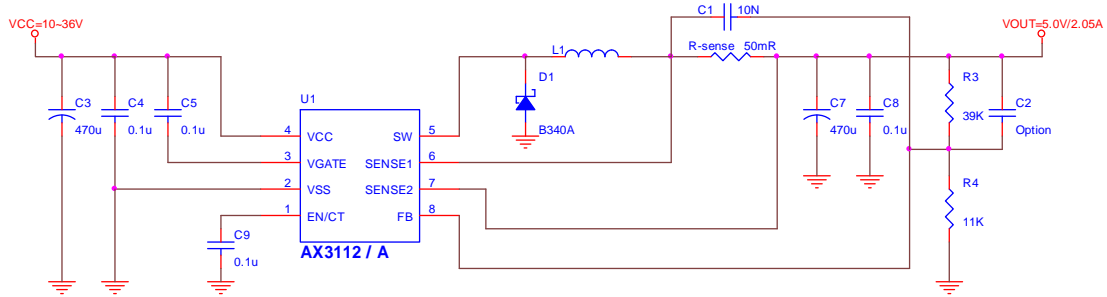

$$V_{OUT} = 1.1V \times \left(1 + \frac{R3}{R4}\right)$$

L1 recommend value (V _{IN} =10~36V, V _{OUT} =5V)		
Version	AX3112	AX3112A
L1 Value (H)	66u	22u

(2) MLCC

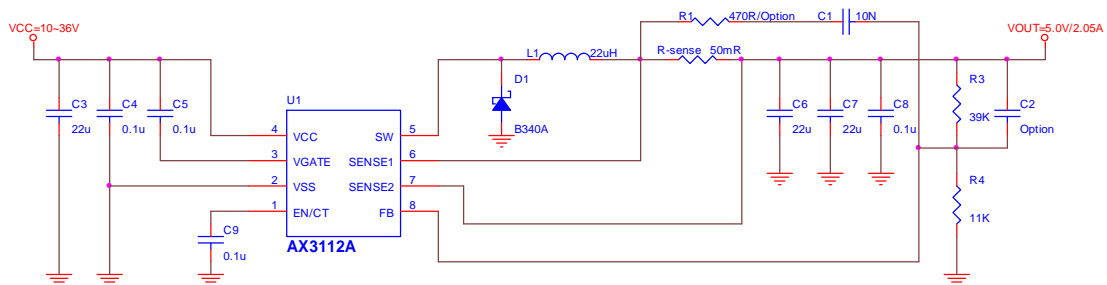

❖ FUNCTION DESCRIPTIONS

SENSE1/2

The current limit sense pin, if $V_{SENSE1} - V_{SENSE2} \geq 125mV$, the over current is happened that it can turn-off driver cycle by cycle.

EN/CT

The pin is enable/shutdown and auto restart control functions. When system is normal operating, this pin is enable/shutdown function. Pulling this pin below a threshold voltage of under 0.3V shuts the regulator off, and pulling this pin from 0.5V to 1.5V turns the regulator on. However when V_{OUT} is short ($V_{FB} < 0.4V$), the auto restart function can be started that restart the regulator cycle by cycle. The cycle time is set by outside capacitor (C6). Please refer the below waveform and formula, the t2 cycle is regulator off time and t1 cycle is current limit time. The charge-current is 32uA and discharge-current is 1.5uA.

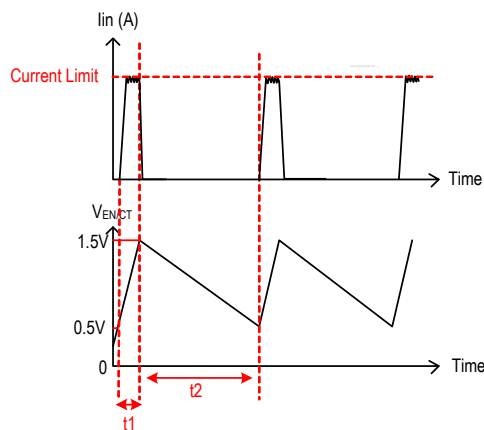

$$t_1 = C_6 \times \frac{1}{32u} \text{ (Sec.)}$$

$$t_2 = C_6 \times \frac{1}{1.5u} \text{ (Sec.)}$$

Under Voltage Lockout (UVLO)

To avoid error-operation of the device at low input voltages an under voltage lockout is included that disables the device, if the input voltage falls below 6.0V.

Current Limit Protection

The Current limit is set by outside resistance (R_{SENSE}), When the SENSE1-SENSE2 voltage larger than 125mV, the current limit is happened that driver can be turned off until the drop is small than 80mV. The current limit set according to the following equation:

$$\text{Current Limit (A)} = \frac{125\text{m} + (125 - 45)\text{m}}{2 \times R_{SENSE}}$$

The maximum output current table is shown as below; please refer the table to design.

RSENSE (Ω)	Maximum Output Current (A)
50m	2.05
100m	1.03

Freq =350KHz

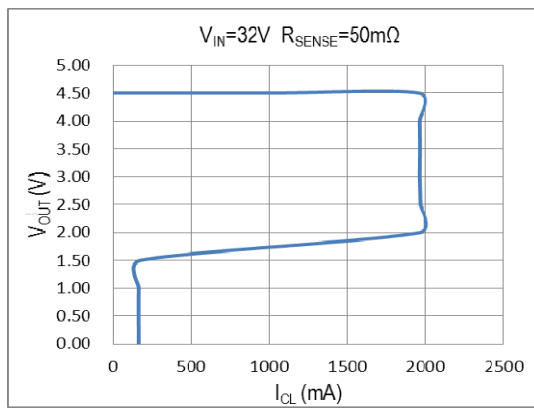
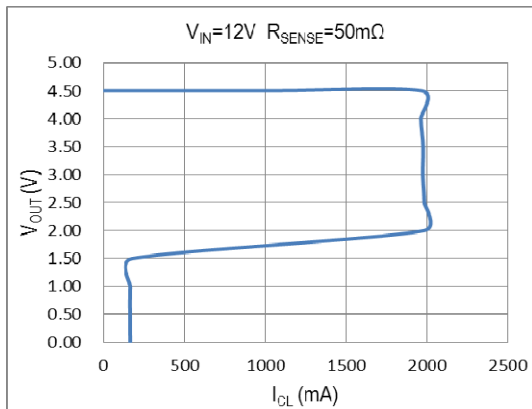

Freq =100KHz

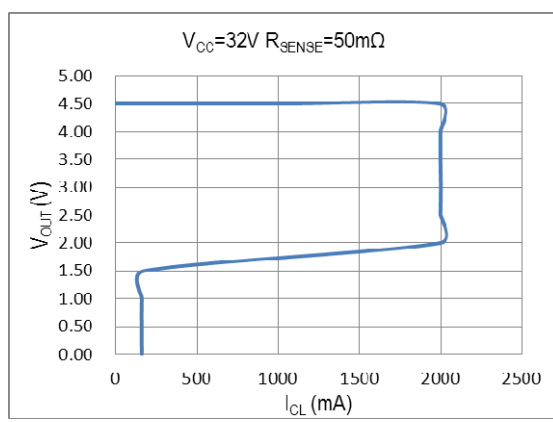
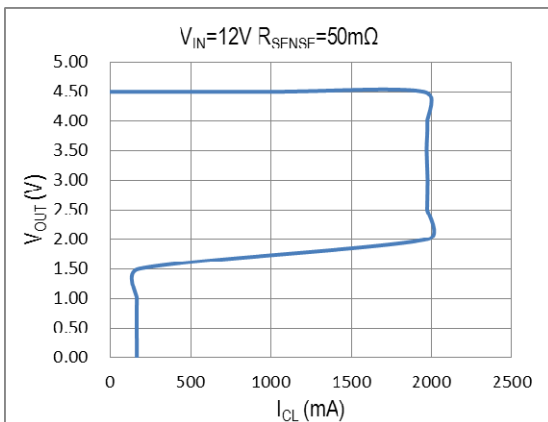

Thermal Considerations

The SOP-8L-EP package needs a heat sink under most conditions. The heat sink connect exposed pad of AX3112/A to obtain best effect. The size of the heat sink depends on the input voltage, output voltage, output current and ambient temperature.

❖ TYPICAL CHARACTERISTICS

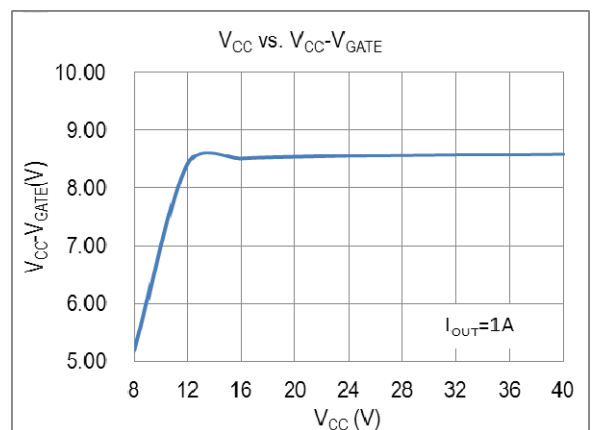
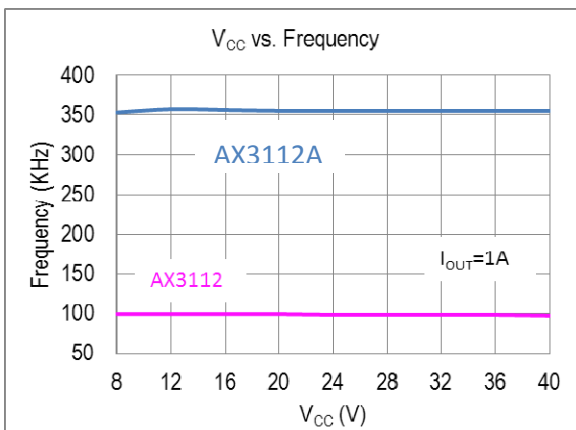
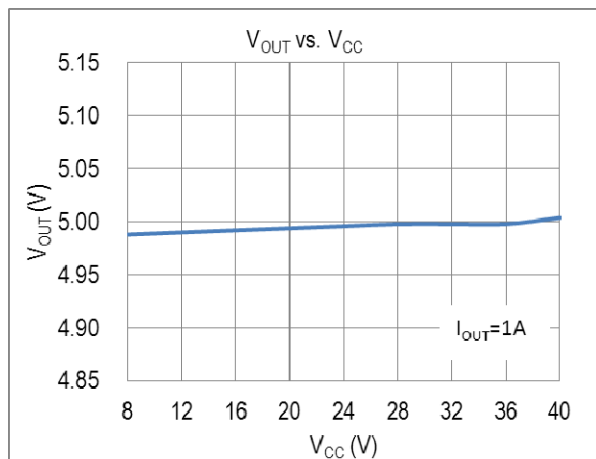
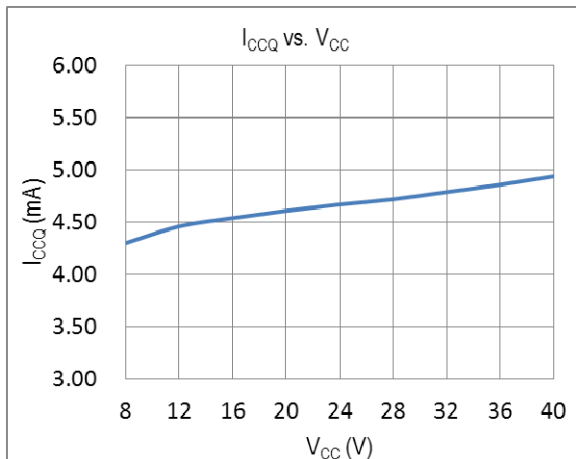

❖ TYPICAL CHARACTERISTICS (CONTINUOUS)

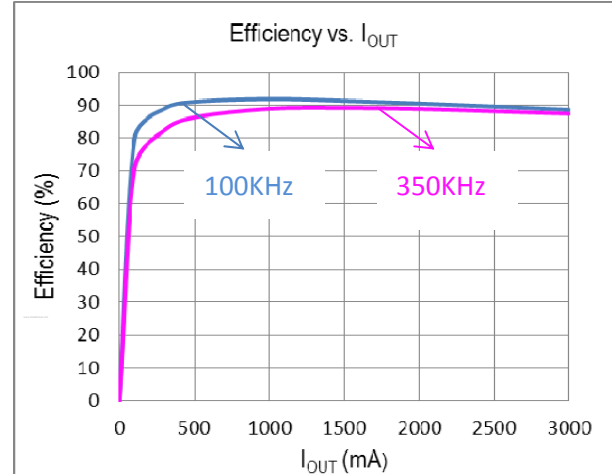
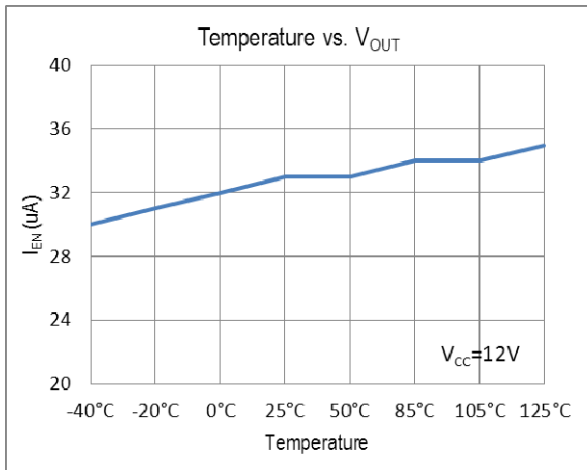
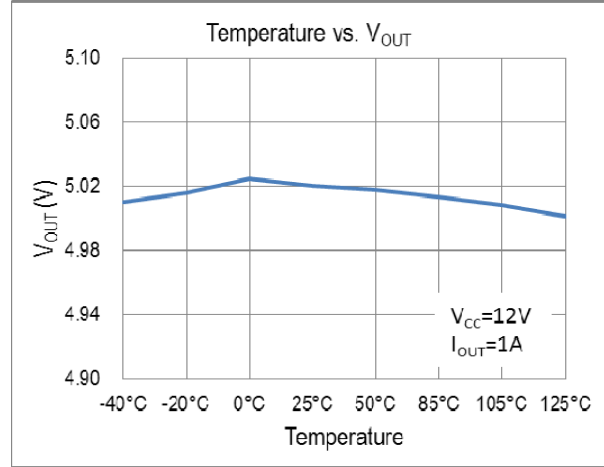
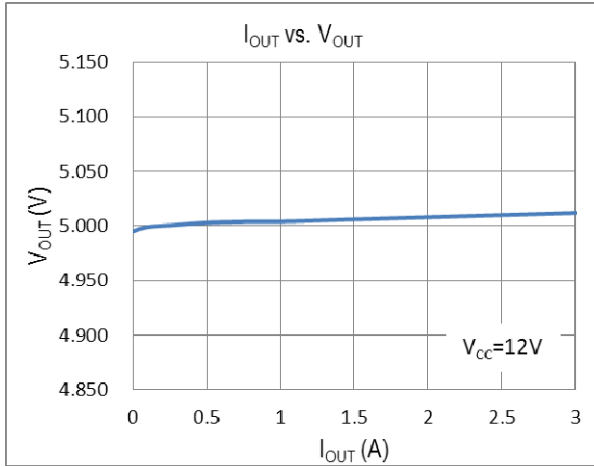

V_{CC}=32V, V_{OUT}=5V, I_{OUT}=1.2A,
 C_{EN}=0.1u C_{OUT}=470u

V_{CC} =32V, V_{OUT}=5V, I_{OUT}=1.0A,
 C_{EN}=0.1u, C_{OUT}=40u

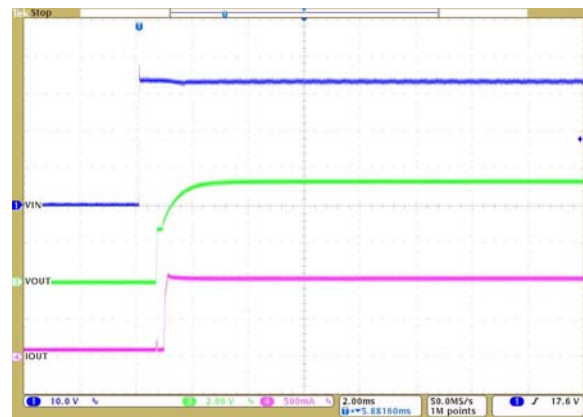
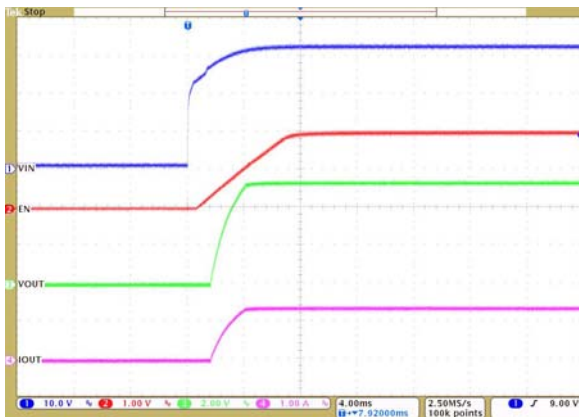

❖ TYPICAL CHARACTERISTICS (CONTINUOUS)

$V_{CC}=12V, V_{OUT}=5V, I_{OUT}=0\sim 2A$

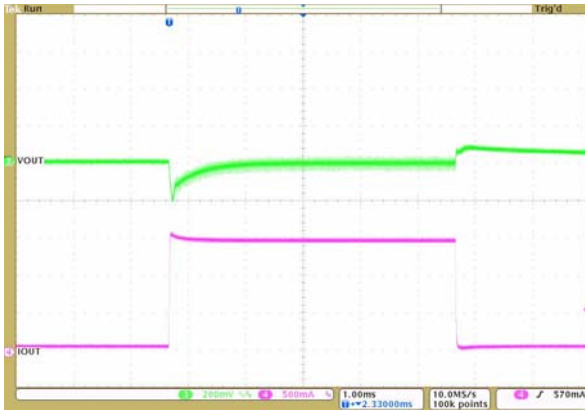

$V_{CC}=32V, V_{OUT}=5V, I_{OUT}=0\sim 2A$

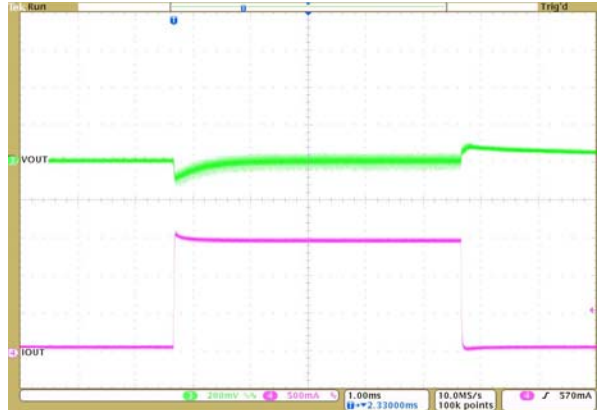

$V_{CC}=32V, V_{OUT}=1.2V, I_{OUT}=1.5A$

Thermal Shutdown Release

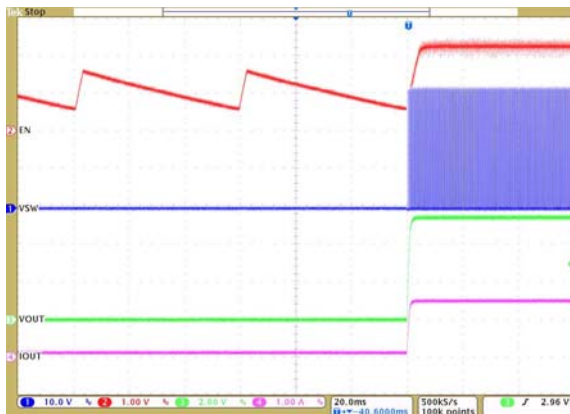

$V_{CC}=32V, V_{OUT}=5V, I_{OUT}=1.5A$

Short Circuit Release

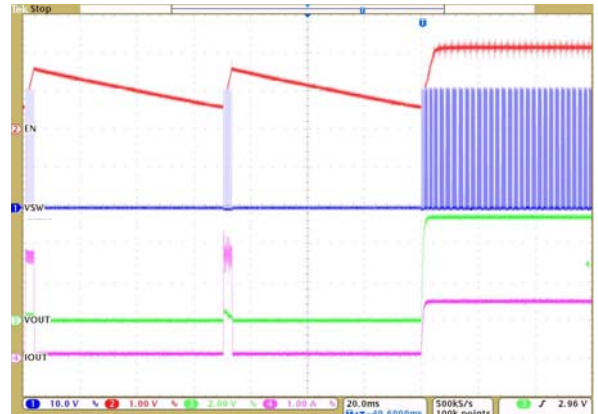

❖ PACKAGE OUTLINES

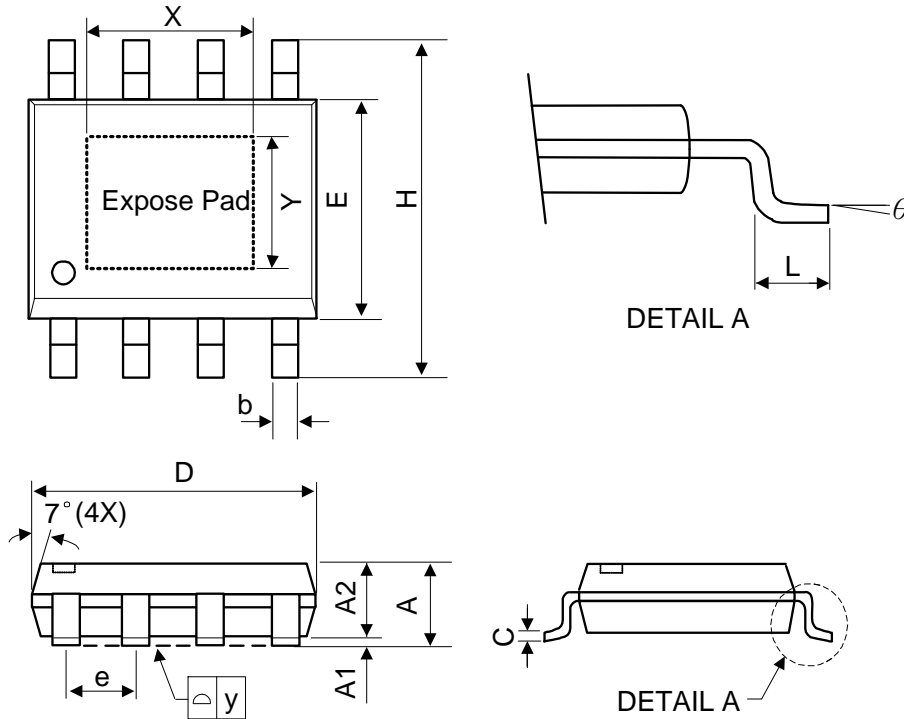

Symbol	Dimensions in Millimeters			Dimensions in Inches		
	Min.	Nom.	Max.	Min.	Nom.	Max.
A	-	-	1.75	-	-	0.069
A1	0	-	0.15	0	-	0.06
A2	1.25	-	-	0.049	-	-
C	0.1	0.2	0.25	0.0075	0.008	0.01
D	4.7	4.9	5.1	0.185	0.193	0.2
E	3.7	3.9	4.1	0.146	0.154	0.161
H	5.8	6	6.2	0.228	0.236	0.244
L	0.4	-	1.27	0.015	-	0.05
b	0.31	0.41	0.51	0.012	0.016	0.02
e	1.27 BSC			0.050 BSC		
y	-	-	0.1	-	-	0.004
X	-	2.34	-	-	0.092	-
Y	-	2.34	-	-	0.092	-
θ	0°	-	8°	0°	-	8°

Mold flash shall not exceed 0.25mm per side

JEDEC outline: MS-012 BA