

**PLEASE CHECK WWW.MOLEX.COM FOR LATEST PART INFORMATION**

**Part Number:** [0877602216](#)  
**Status:** **Active**  
**Overview:** milligrd  
**Description:** 2.00mm (.079") Pitch Milli-Grid™ Header, Right Angle, Through Hole, 22 Circuits, 0.38µm (15µ") Gold (Au) Selective Plating, Tray, Lead-free

**Documents:**

[3D Model](#) [Product Specification PS-87761-100 \(PDF\)](#)  
[Drawing \(PDF\)](#) [RoHS Certificate of Compliance \(PDF\)](#)

**Agency Certification**

CSA LR19980  
 UL E29179

**General**

Product Family PCB Headers  
 Series [87760](#)  
 Application Board-to-Board, Wire-to-Board  
 Comments Lead-free version of 87049 series  
 Overview [milligrd](#)  
 Product Name Milli-Grid™

**Physical**

Breakaway No  
 Circuits (Loaded) 22  
 Circuits (maximum) 22  
 Color - Resin Black  
 First Mate / Last Break No  
 Flammability 94V-0  
 Glow-Wire Compliant No  
 Guide to Mating Part No  
 Keying to Mating Part None  
 Lock to Mating Part None  
 Mated Height (in) 0.157 In  
 Mated Height (mm) 4.00 mm  
 Material - Metal Phosphor Bronze  
 Material - Plating Mating Gold  
 Material - Plating Termination Tin  
 Material - Resin High Temperature Thermoplastic  
 Number of Rows 2  
 Orientation Right Angle  
 PC Tail Length (in) 0.102 In  
 PC Tail Length (mm) 2.60 mm  
 PCB Locator No  
 PCB Retention None  
 PCB Thickness Recommended (in) 0.062 In  
 PCB Thickness Recommended (mm) 1.60 mm  
 Packaging Type Tray  
 Pitch - Mating Interface (in) 0.079 In  
 Pitch - Mating Interface (mm) 2.00 mm  
 Pitch - Term. Interface (in) 0.079 In  
 Pitch - Term. Interface (mm) 2.00 mm  
 Plating min: Mating (µin) 15  
 Plating min: Mating (µm) 0.38  
 Plating min: Termination (µin) 76.4  
 Plating min: Termination (µm) 1.91



*image - Reference only*

**EU RoHS**

**ELV and RoHS Compliant**  
**REACH SVHC**  
 Not Reviewed  
**Halogen-Free Status**  
**Not Reviewed**

**China RoHS**



**Need more information on product environmental compliance?**

Email [productcompliance@molex.com](mailto:productcompliance@molex.com)  
 For a multiple part number RoHS Certificate of Compliance, [click here](#)

Please visit the [Contact Us](#) section for any non-product compliance questions.

**Search Parts in this Series**

[87760Series](#)

**Mates With**

[79107](#) Milli-Grid™ Receptacle, Vertical, Through Hole. [79108](#) Milli-Grid™ Flex-to-Board, Vertical Receptacle. Milli-Grid™ Receptacle, Surface Mount. [79109](#). [87381](#)

Polarized to Mating Part	No
Polarized to PCB	No
Shrouded	No
Stackable	Yes
Surface Mount Compatible (SMC)	Yes
Temperature Range - Operating	-55°C to +105°C
Termination Interface: Style	Through Hole

### **Electrical**

Current - Maximum per Contact	2A
Voltage - Maximum	125V

### **Solder Process Data**

Duration at Max. Process Temperature (seconds)	14
Lead-free Process Capability	Wave Capable (TH only)
Max. Cycles at Max. Process Temperature	1
Process Temperature max. C	265

### **Material Info**

#### **Reference - Drawing Numbers**

Product Specification	PS-87761-100
Sales Drawing	SD-87760-109

This document was generated on 05/26/2010

**PLEASE CHECK [WWW.MOLEX.COM](http://WWW.MOLEX.COM) FOR LATEST PART INFORMATION**

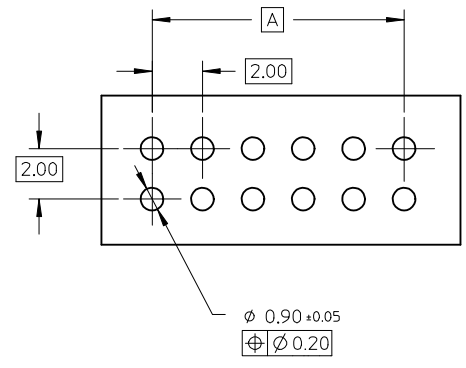

RECOMMENDED PCB LAYOUT

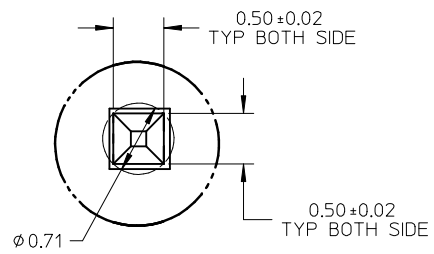
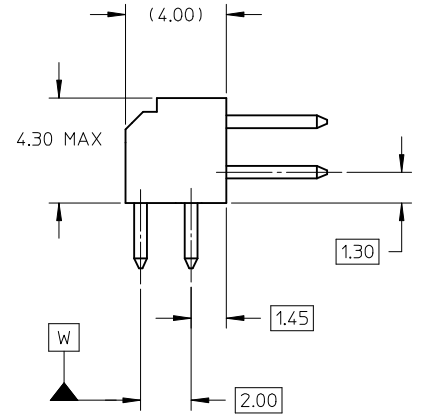

DETAIL Z

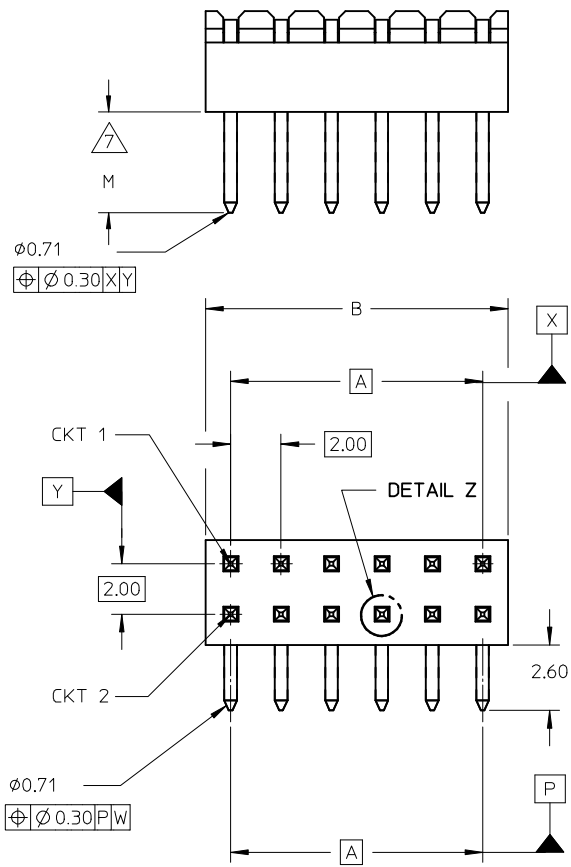

NOTES:

1. MATERIAL:
    - HSG: PCT, 30% GLASS FILLED, UL 94V-0, COLOUR BLACK.
    - PIN: 0.50MM SQ PHOSPHOR BRONZE 510
  2. PLATING:
    - \*\*\*6 - 0.38um MIN GOLD IN CONTACT AREA, 1.90um MIN TIN IN SOLDERTAIL AREA, BOTH OVER 1.27um MIN NICKEL OVERALL
    - \*\*\*7 - 0.76um MIN GOLD IN CONTACT AREA, 1.90um MIN TIN IN SOLDERTAIL AREA, BOTH OVER 1.27um MIN NICKEL OVERALL
    - \*\*\*8 - 2.54um MIN TIN OVER 1.27um MIN NICKEL OVERALL
  3. 12 CKT USED FOR ILLUSTRATION ONLY
  4. PART TO BE PACKED IN POCKET TRAY/TUBE (SEE TABLE).
  5. PRODUCT SPEC PS-87761-100 APPLIES.
  6. RECOMMENDED PCB BOARD THK 1.60±0.10 MM.
7. MATING LENGTH: 1 - 4.00MM  
2 - 3.50MM  
3 - 3.06MM  
4 - 5.75MM

LEGEND:

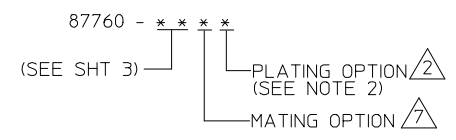

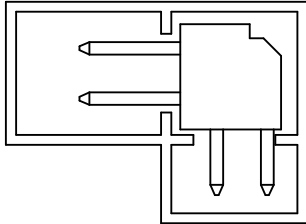

0047-DW-SIRIUS EC NO: S2010-0177 DRWN:SKANG CHKD:ATSEE APPR:MLONG 2009/10/21 2009/10/22 2009/10/23	QUALITY SYMBOLS	GENERAL TOLERANCES (UNLESS SPECIFIED)	DIMENSION STYLE	SCALE	DESIGN UNITS	THIRD ANGLE PROJECTION
	$\nabla=0$ $\sphericalcap=0$	mm    INCH 4 PLACES ± --- ± --- 3 PLACES ± --- ± --- 2 PLACES ± 0.2 ± --- 1 PLACE ± --- ± --- ANGULAR ± 3°	MM ONLY	NTS	METRIC	
	DESCRIPTION	DRAFT WHERE APPLICABLE MUST REMAIN WITHIN DIMENSIONS	DRAWN BY	DATE	TITLE	
			KSEE	2003/10/15	MGRID, 2MM DUAL ROW HDR. R/A	
			KCL ING	2003/12/02		
REV		APPROVED BY	DATE	MOLEX INCORPORATED		
A11		SKTOH	2003/12/11	SD-87760-109		
		MATERIAL NO.	SEE TABLE	DOCUMENT NO.		SHEET NO.
		SIZE	A3	THIS DRAWING CONTAINS INFORMATION THAT IS PROPRIETARY TO MOLEX INCORPORATED AND SHOULD NOT BE USED WITHOUT WRITTEN PERMISSION		1 OF 2

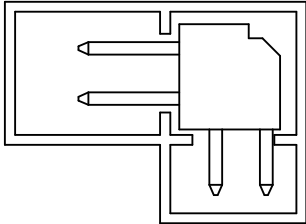
	10	9	8	7	6	5	4	3	2	1	
	PART NUMBER	VOID PIN LOCATION	CKT SIZE	A	B	M	PACKAGING TYPE				
F	87760-04**	-	04	2.00	4.00	REFER TO NOTE 7.	TRAY		PART IN TUBE		
	87760-06**	-	06	4.00	6.00						
	87760-08**	-	08	6.00	8.00						
	87760-10**	-	10	8.00	10.00						
	87760-12**	-	12	10.00	12.00						
	87760-14**	-	14	12.00	14.00						
	87760-16**	-	16	14.00	16.00						
E	87760-18**	-	18	16.00	18.00						
	87760-20**	-	20	18.00	20.00						
	87760-22**	-	22	20.00	22.00						
	87760-24**	-	24	22.00	24.00						
	87760-26**	-	26	24.00	26.00						
	87760-28**	-	28	26.00	28.00						
D	87760-30**	-	30	28.00	30.00						
	87760-32**	-	32	30.00	32.00						
	87760-34**	-	34	32.00	34.00						
	87760-36**	-	36	34.00	36.00						
	87760-38**	-	38	36.00	38.00						
	87760-40**	-	40	38.00	40.00						
C	87760-42**	-	42	40.00	42.00						
	87760-44**	-	44	42.00	44.00						
	87760-46**	-	46	44.00	46.00						
	87760-48**	-	48	46.00	48.00						
	87760-50**	-	50	48.00	50.00						
	87760-5116	5, 6 & 26	50	48.00	50.00						
B	87760-5248	-	28	26.00	28.00	TUBE					



PART IN TUBE

<b>0047-DW-SIRIUS</b> EC NO: S2010-0177 DRWN:SKANG 2009/10/21 CHKD:ATSEE 2009/10/22 APPR:MLONG 2009/10/23	QUALITY SYMBOLS	GENERAL TOLERANCES (UNLESS SPECIFIED)		DIMENSION STYLE		SCALE	DESIGN UNITS	THIRD ANGLE PROJECTION		
	 =0  =0	mm	INCH	MM ONLY		NTS	METRIC			
		4 PLACES	± ---	± ---	DRAWN BY	DATE	TITLE			
		3 PLACES	± ---	± ---	KSEE	2003/10/15	MGRID, 2MM DUAL ROW HDR. R/A			
		2 PLACES	± 0.2	± ---	CHECKED BY	DATE	MATERIAL NO.			
	1 PLACE	± ---	± ---	KCLING	2003/12/02	DOCUMENT NO.				
	ANGULAR ± 3 °			APPROVED BY	DATE	SHEET NO.				
	DRAFT WHERE APPLICABLE MUST REMAIN WITHIN DIMENSIONS			SKTOH	2003/12/11	SD-87760-109				
				SEE TABLE		THIS DRAWING CONTAINS INFORMATION THAT IS PROPRIETARY TO MOLEX INCORPORATED AND SHOULD NOT BE USED WITHOUT WRITTEN PERMISSION				
				SIZE	A3					