



GaAs MMIC NON-REFLECTIVE DIFFERENTIAL SPDT SWITCH, DC - 4 GHz

Typical Applications

The HMC922LP4E is ideal for:

- Test & Measurement Equipment
- Antenna Diversity & Selector Selection
- Broadband Switch Matrices
- Military, EW & ECM
- SATCOM & Space

Features

- Differential SPDT Functionality
- Low Insertion Loss: 0.8 dB
- High IP3: +50 dBm
- High Input P1dB: +35 dBm
- Positive Control: 0/+3V to 0/+5V
- 24 Lead 4x4 mm QFN Package: 16 mm²

Functional Diagram

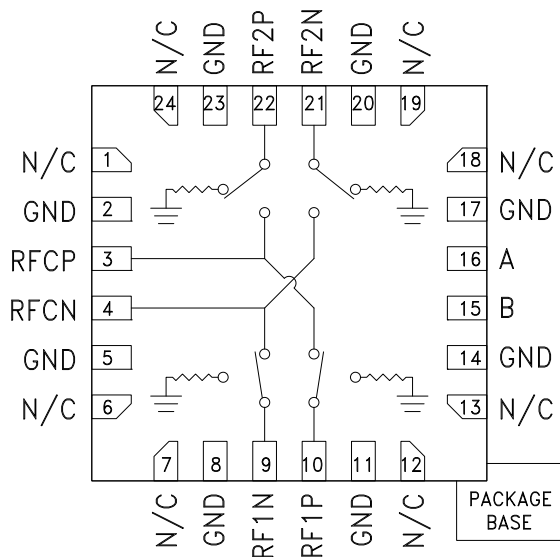

General Description

The HMC922LP4E is a DC to 4 GHz high isolation GaAs MMIC non-reflective Differential SPDT switch in a low cost leadless surface mount package. The switch is ideal for antenna diversity & selector selection, broadband switch matrices, test & measurement equipment, military and space applications yielding up to 60 dB isolation, low 0.8 dB insertion loss and +50 dBm input IP3. Power handling is excellent with the switch offering a P1dB compression point of +35 dBm. On-chip circuitry allows two positive voltage controls of 0/+3V to 0/+5V at very low DC currents.

Electrical Specifications,

$T_A = +25^\circ C$, $V_{ctl} = 0/+3 Vdc$ (Unless Otherwise Stated), 50 Ohm System

Parameter	Frequency	Min.	Typ.	Max.	Units
Insertion Loss	DC - 2.0 GHz 2.0 - 4.0 GHz		0.8 1.2	1.2 1.5	dB dB
Isolation:	State 1: RFCN-RF2P, RFCN-RF2N, RFCP-RF2N, RFCP-RF2P State 2: RFCN-RF1P, RFCN-RF1N, RFCP-RF1N, RFCP-RF1P	DC - 2.0 GHz 2.0 - 4.0 GHz	45 40	60 45	dB dB
Isolation	State 1: RFCN-RF1P, RFCP-RF1N State 2: RFCN-RF2P, RFCP-RF2N	DC - 2.0 GHz 2.0 - 4.0 GHz	30 20	40 30	dB dB
Return Loss (On State, Any Port)	DC - 2.0 GHz 2.0 - 4.0 GHz		20 15		dB dB
Input Power for 1 dB Compression	$V_{ctl} = 0/+3V$ $V_{ctl} = 0/+5V$	0.5 - 4.0 GHz		30 35	dBm dBm
Input Power for 0.1 dB Compression	$V_{ctl} = 0/+3V$ $V_{ctl} = 0/+5V$	0.5 - 4.0 GHz		27 32	dBm dBm
Input Third Order Intercept (Two-Tone Input Power= +7 dBm Each Tone)	$V_{ctl} = 0/+3V$ $V_{ctl} = 0/+5V$	0.5 - 4.0 GHz		50 50	dBm dBm
Switching Characteristics		DC - 4.0 GHz			
	t_{RISE} / t_{FALL} (10/90% RF) t_{ON} / t_{OFF} (50% CTL to 10/90% RF)			15 40	ns ns

For price, delivery and to place orders: Hittite Microwave Corporation, 20 Alpha Road, Chelmsford, MA 01824

Phone: 978-250-3343 Fax: 978-250-3373 Order On-line at www.hittite.com

Application Support: Phone: 978-250-3343 or apps@hittite.com

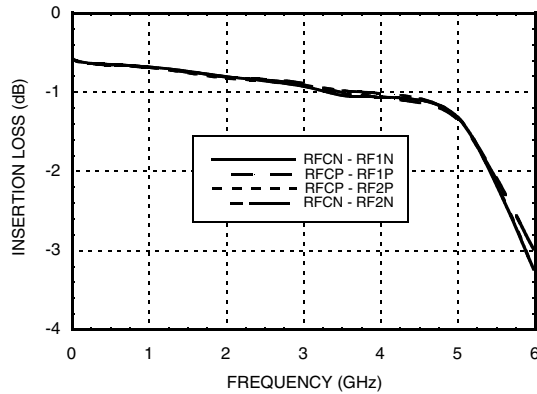
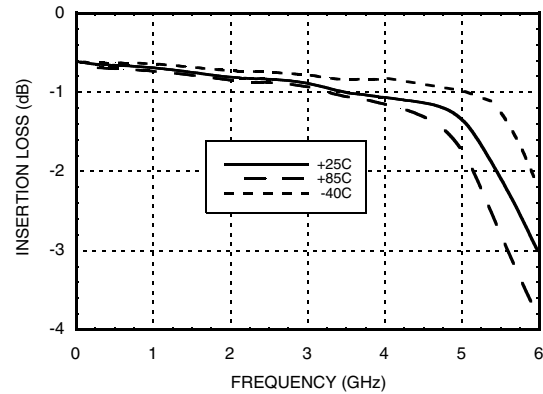
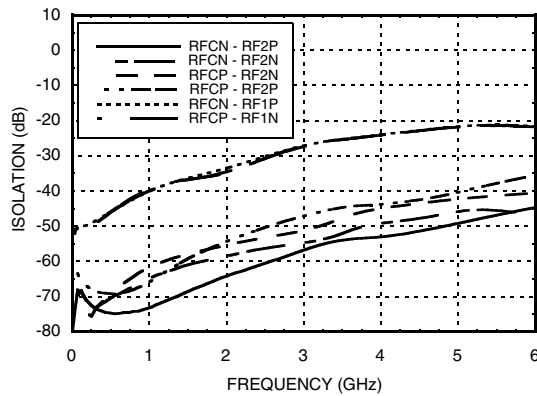
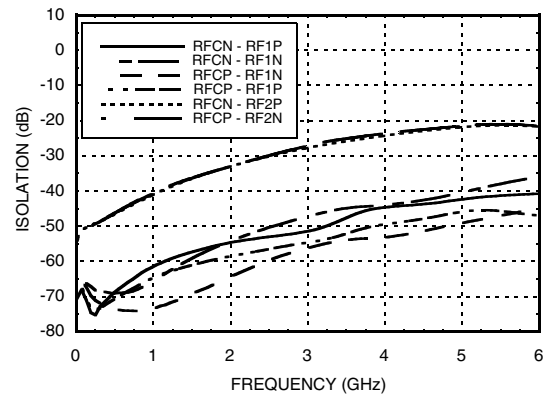
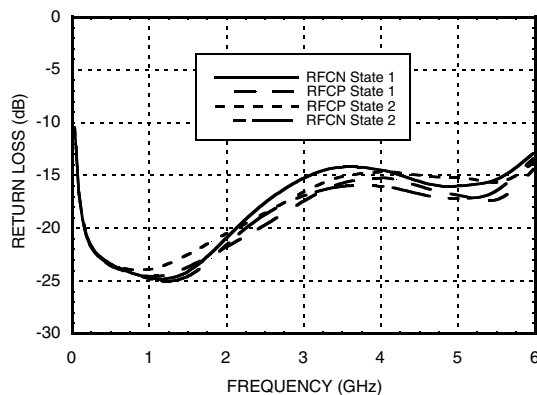
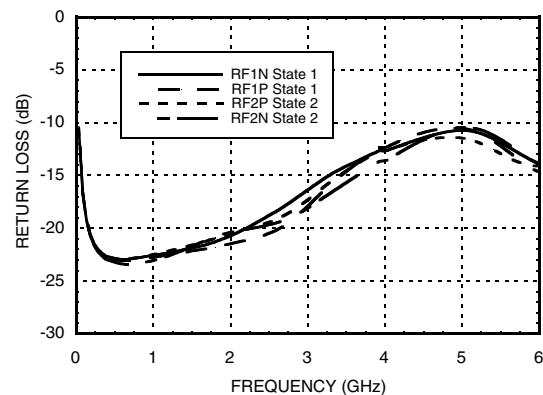
**GaAs MMIC NON-REFLECTIVE
DIFFERENTIAL SPDT SWITCH, DC - 4 GHz**
Insertion Loss

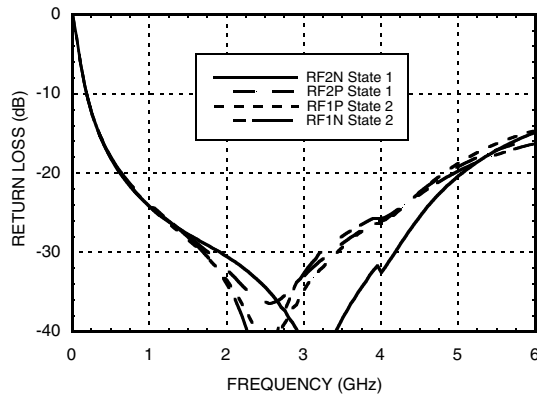
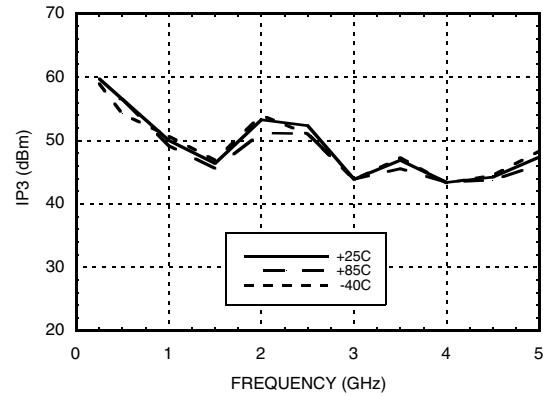
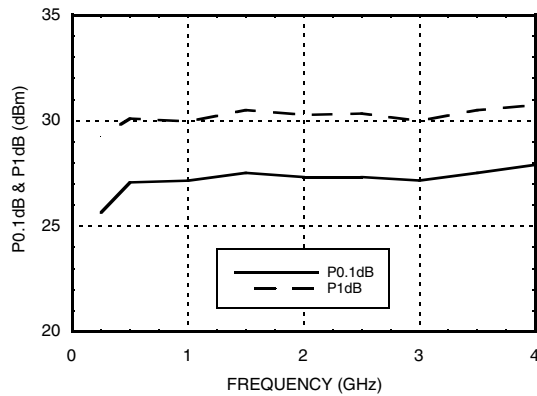
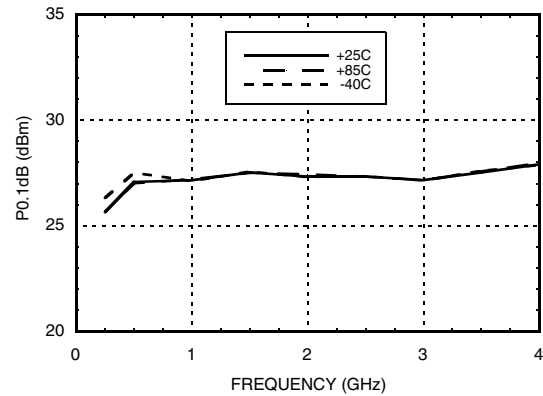
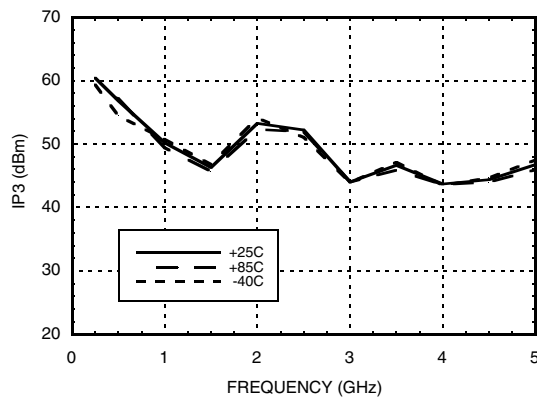
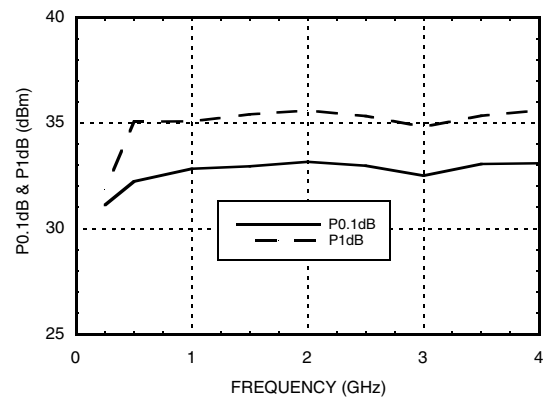
Insertion Loss vs. Temperature

Isolation State 1

Isolation State 2

Return Loss RFC

Return Loss RF1, 2

**GaAs MMIC NON-REFLECTIVE
DIFFERENTIAL SPDT SWITCH, DC - 4 GHz**
Off State Return Loss

Input IP3* @ 3V

**Input 0.1dB & 1 dB
Compression Point @ 3V**

**Input 0.1dB Compression Point
vs. Temperature @ 3V**

Input IP3 * @ 5V

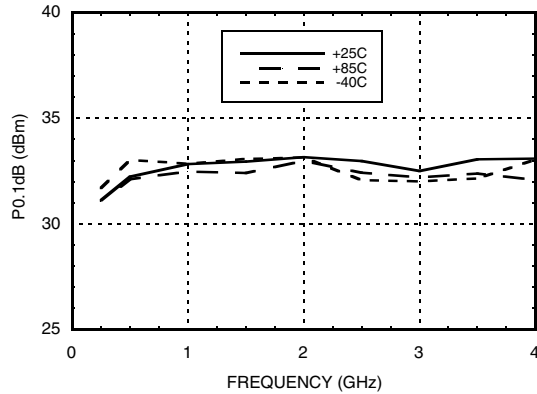
**Input 0.1 dB & 1 dB Compression
Point @ 5V**

* Two-tone input power = +7 dBm each tone, 1 MHz spacing.



GaAs MMIC NON-REFLECTIVE DIFFERENTIAL SPDT SWITCH, DC - 4 GHz

Input 0.1 dB Compression Point vs. Temperature @ 5V



Insertion Loss Amplitude Mismatch

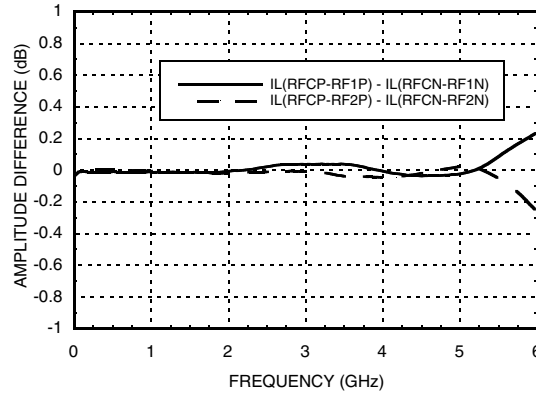

Insertion Loss Phase Mismatch

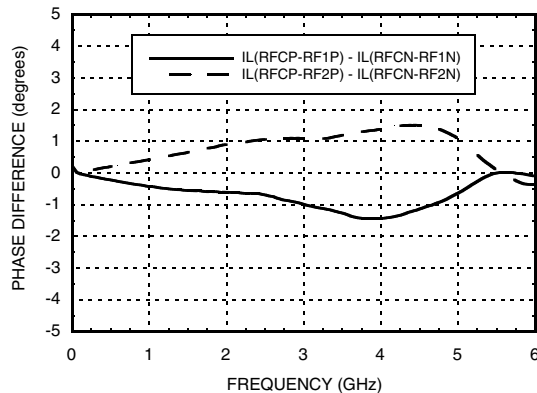

Group Delay Mismatch

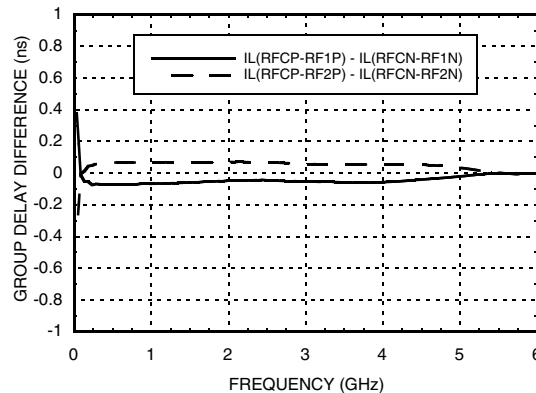

Absolute Maximum Ratings

Control Voltage (A, B)	-0.5V to 8V DC
RF Input Power	
Through Path 3V/5V	32 / 34 dBm
Termination Path 3V/5V	26 dBm
Channel Temperature	150 °C
Thermal Resistance (channel to package ground paddle)	
Through Path	30 °C/W
Termination Path	79 °C/W
Storage Temperature	-65 to +150 °C
Operating Temperature	-40 to +85 °C
ESD Sensitivity (HBM)	Class 1A

Control Voltages

State	Bias Condition
Low	0 to +0.5 Vdc @ < 1 μA Typ.
High	+3.0 to +5.5 Vdc @ 20 μA Typ.

Truth Table

	Control Input		Signal Path State	
	A	B	RFCP to:	RFNCN to:
State 1	Low	High	RF1P	RF1N
State 2	High	Low	RF2P	RF2N

Do not operate continuously at RF power input greater than 1 dB compression and do not hot switch power levels greater than +27 dBm for control = 0/+3 Vdc, or +30 dBm for control = 0/+5 Vdc.



**ELECTROSTATIC SENSITIVE DEVICE
OBSERVE HANDLING PRECAUTIONS**

GaAs MMIC NON-REFLECTIVE DIFFERENTIAL SPDT SWITCH, DC - 4 GHz

Outline Drawing

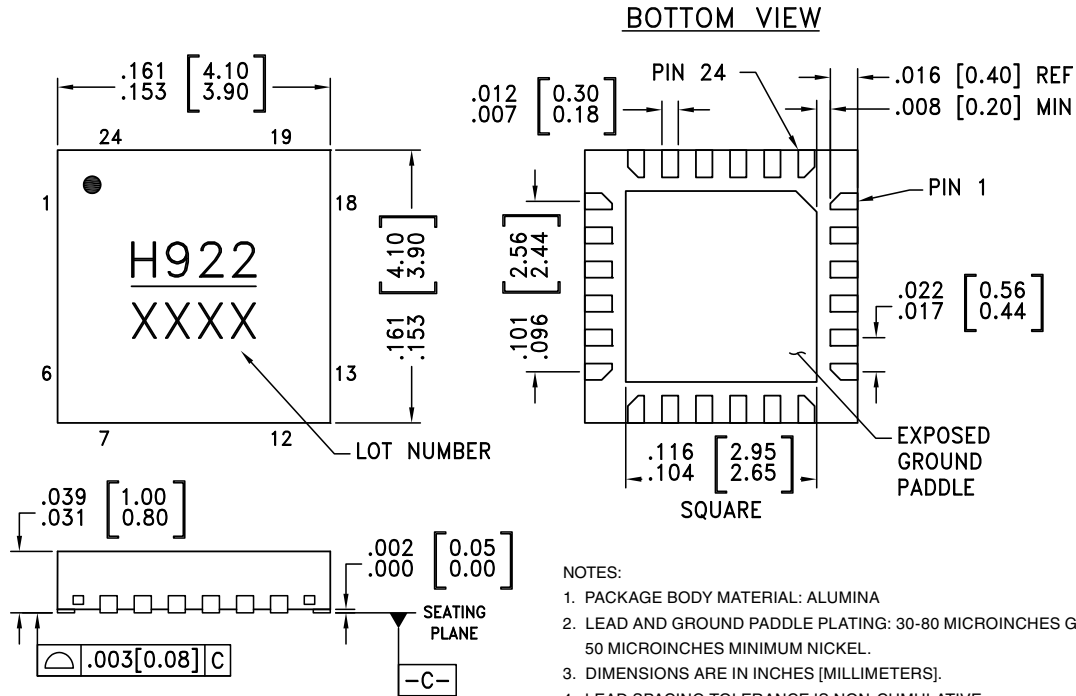

NOTES:

1. PACKAGE BODY MATERIAL: ALUMINA
2. LEAD AND GROUND PADDLE PLATING: 30-80 MICROINCHES GOLD OVER 50 MICROINCHES MINIMUM NICKEL.
3. DIMENSIONS ARE IN INCHES [MILLIMETERS].
4. LEAD SPACING TOLERANCE IS NON-CUMULATIVE
5. PACKAGE WARP SHALL NOT EXCEED 0.05mm DATUM $\boxed{-C-}$
6. ALL GROUND LEADS AND GROUND PADDLE MUST BE SOLDERED TO PCB RF GROUND.
7. CLASSIFIED AS MOISTURE SENSITIVITY LEVEL (MSL) 1.

Package Information

Part Number	Package Body Material	Lead Finish	MSL Rating	Package Marking ^[1]
HMC922LP4E	RoHS-compliant Low Stress Injection Molded Plastic	100% matte Sn	MSL1 ^[2]	H922 XXXX

[1] 4-Digit lot number XXXX

[2] Max peak reflow temperature of 260 °C

Pin Descriptions

Pin Number	Function	Description	Interface Schematic
3, 4, 9, 10, 21, 22	RF1P, RF1N, RF2P, RF2N	These pins are DC coupled and matched to 50 Ohms. Blocking capacitors are required.	
1, 6, 7, 12, 13, 18, 19, 24	N/C	The pins are not connected internally; however, all data shown herein was measured with these pins connected to RF/DC ground externally.	
2, 5, 8, 11, 14, 17, 20, 23	GND	Package bottom has exposed metal paddle that must be connected to PCB RF ground as well.	
16	A	See truth and control voltage tables.	
15	B	See truth and control voltage tables.	

**GaAs MMIC NON-REFLECTIVE
DIFFERENTIAL SPDT SWITCH, DC - 4 GHz**

Evaluation PCB

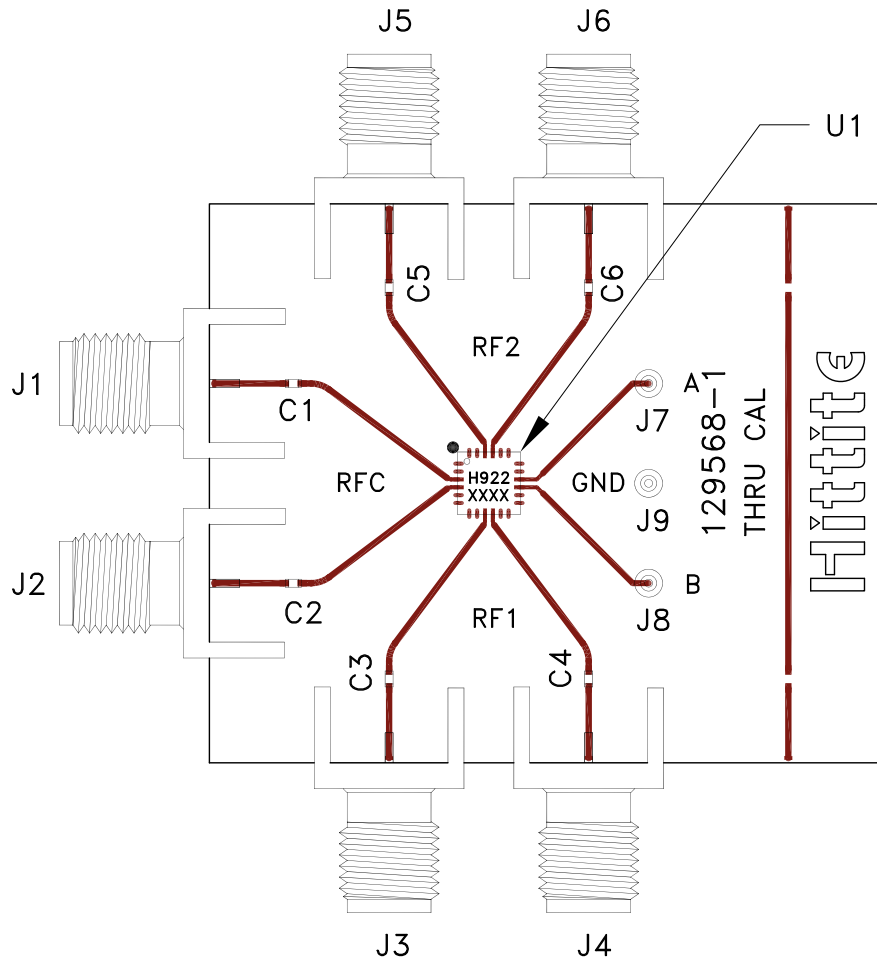

List of Materials for Evaluation PCB 129570 [1]

Item	Description
J1 - J6	PCB Mount SMA RF Connector
J7 - J9	DC Pin
C1 - C6	330 pF Capacitor, 0402 Pkg.
U1	HMC922LP4E SPDT Switch
PCB [2]	129568 Evaluation PCB

[1] Reference this number when ordering complete evaluation PCB

[2] Circuit Board Material: Rogers 4350

The circuit board used in the application should use RF circuit design techniques. Signal lines should have 50 Ohm impedance while the package ground leads and exposed paddle should be connected directly to the ground plane similar to that shown above. A sufficient number of via holes should be used to connect the top and bottom ground planes. The evaluation circuit board shown above is available from Hittite upon request.