

## Dolby\* B-C Type Noise Reduction System for Playback

### Description

The CXA2502M is a bipolar IC incorporating stereo Dolby B-C type noise reduction (NR) system for playback.

Pins of this IC are compatible with those of the Dolby B type NR ICs CXA1102M/ CXA1552M.

A reduction in the number of external parts and small package have been achieved due to the fact that the spectral skewing circuits are all on-chip and this IC is intended for playback.

16 pin SOP (Plastic)

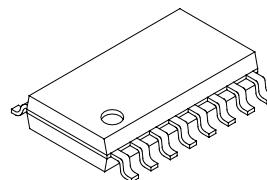

### Features

- Few external parts
- Spectral skewing circuit are on-chip
- NR OFF/B/C and AUX/TAPE switches
- Small package (16-pin SOP)
- Low current consumption 12mA Typ.
- Built-in two channels

### Structure

Bipolar silicon monolithic IC

### Absolute Maximum Ratings (Ta = 25°C)

• Supply voltage	V <sub>CC</sub>	17	V
• Operating temperature	T <sub>opr</sub>	-40 to +85	°C
• Storage temperature	T <sub>stg</sub>	-65 to +150	°C
• Allowable power dissipation	P <sub>D</sub>	600 (SOP)	mW

\* This IC is available only to the licensees of Dolby Laboratories Licensing Corporation from whom licensing and applications information may be obtained.

\* "Dolby" and the double D symbols are trademarks of Dolby Laboratories Licensing Corporation.

Sony reserves the right to change products and specifications without prior notice. This information does not convey any license by any implication or otherwise under any patents or other right. Application circuits shown, if any, are typical examples illustrating the operation of the devices. Sony cannot assume responsibility for any problems arising out of the use of these circuits.

Block Diagram, Pin Configuration and Application Circuit

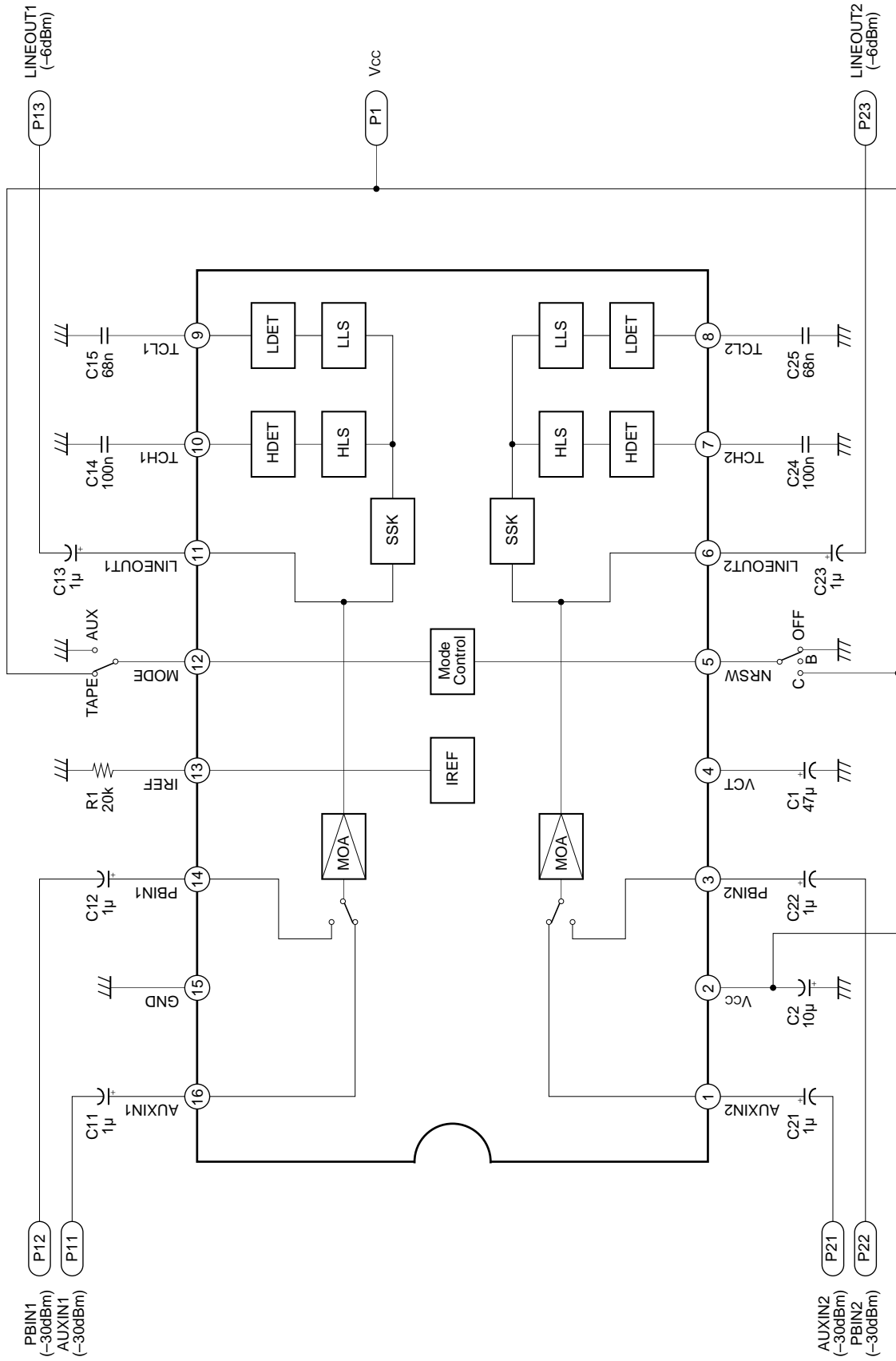

Application circuits shown are typical examples illustrating the operation of the devices. Sony cannot assume responsibility for any problems arising out of the use of these circuits or for any infringement of third party patent and other right due to same.

Pin Description

Pin No.	Symbol	Z (in)	VDC (V)	Equivalent circuit	Description
1 16	AUX IN	40K	VCT		Auxiliary input. Reference level = -30dBm
2	Vcc		Vcc		Positive power supply.
3 14	PB IN	40K	VCT		Playback input. Reference level = -30dBm
4	VCT	0	VCT		Dual power supply: Ground Single power supply: Vcc/2
5	NRSW	—	—		NR control High: C type Medium: B type Low: NR OFF
6 11	LINE OUT	0	VCT		Line output.

Pin No.	Symbol	Z (in)	VDC (V)	Equivalent circuit	Description
7 10	TCH	—	0.4V		Time constant for the HLS.
8 9	TCL	—	0.4V		Time constant for the LLS.
12	MODE	—	—		MODE control High: TAPE Low: AUX
13	IREF	0	1.25V		Reference current which determines the built-in filter cut-off frequency.
15	GND		GND		Dual power supply: Negative power supply Single power supply: Ground

Electrical characteristics

(Ta = 25°C, Vcc = 9V)

Characteristics	Symbol	Measurement conditions*				Min.	Typ.	Max.	Unit
		P/A	NR	f (Hz)	Other conditions				
Operating voltage	Vopr					7.2	—	16.0	V
Current consumption	Icc				No Signal	8.0	12.0	18.0	mA
LINEOUT level	Vlout		OFF	1k		-7.0	-6.0	-5.0	dBm
AUX IN level	Vlin	AUX	OFF	1k		-32	-30	-28	dBm
PB IN level	Vpin	PB	OFF	1k		-32	-30	-28	dBm
Decode characteristics									
B type boost									
(1)	B-R-1	PB	B	500	-25dB	1.4	2.9	4.4	dB
(2)	B-R-2	PB	B	5k	-25dB	3.9	5.4	6.9	dB
(3)	B-R-3	PB	B	10k	-40dB	9.7	10.4	11.4	dB
(4)	B-R-4	PB	B	10k	0dB	-1.1	0.4	1.9	dB
C type boost									
(1)	C-R-1	PB	C	500	-60dB	14.2	16.2	18.2	dB
(2)	C-R-2	PB	C	500	-25dB	7.2	9.2	11.2	dB
(3)	C-R-3	PB	C	2k	-60dB	18.7	20.7	22.7	dB
(4)	C-R-4	PB	C	2k	-25dB	5.4	7.4	9.4	dB
(5)	C-R-5	PB	C	5k	-25dB	3.5	5.5	7.5	dB
(6)	C-R-6	PB	C	10k	0dB	-5.5	-3.5	-1.5	dB
Signal handling	Vomax	PB	OFF	1k	THD = 1%	13.5	16.0	—	dB
Total harmonic distortion									
1) NR OFF	THD (OFF)	PB	OFF	1k	+10dB	—	0.01	0.1	%
2) B	THD (B)	PB	B	1k	+10dB	—	0.03	0.1	%
3) C	THD (C)	PB	C	1k	+10dB	—	0.04	0.2	%
Decode S/N ratio	SN (CCIR)	PB	C	—	Rg = 5kΩ (CCIR/ARM)	75	83	—	dB
REC-PB	CT-1	PB	OFF	1k	0dB	—	-85	-70	dB
PB-REC	CT-2	AUX	OFF	1k	0dB	—	-85	-70	dB
ch to ch	CT-3	PB	OFF	1k	0dB	—	-68	-60	dB
Offset voltage (OFF-C type)	Voff	PB	OFF → C	—		-100	0	100	mV

\* 0dB means the level which provides -6dBm to the line output when NR is off.

Electrical Characteristics Measurement Circuit

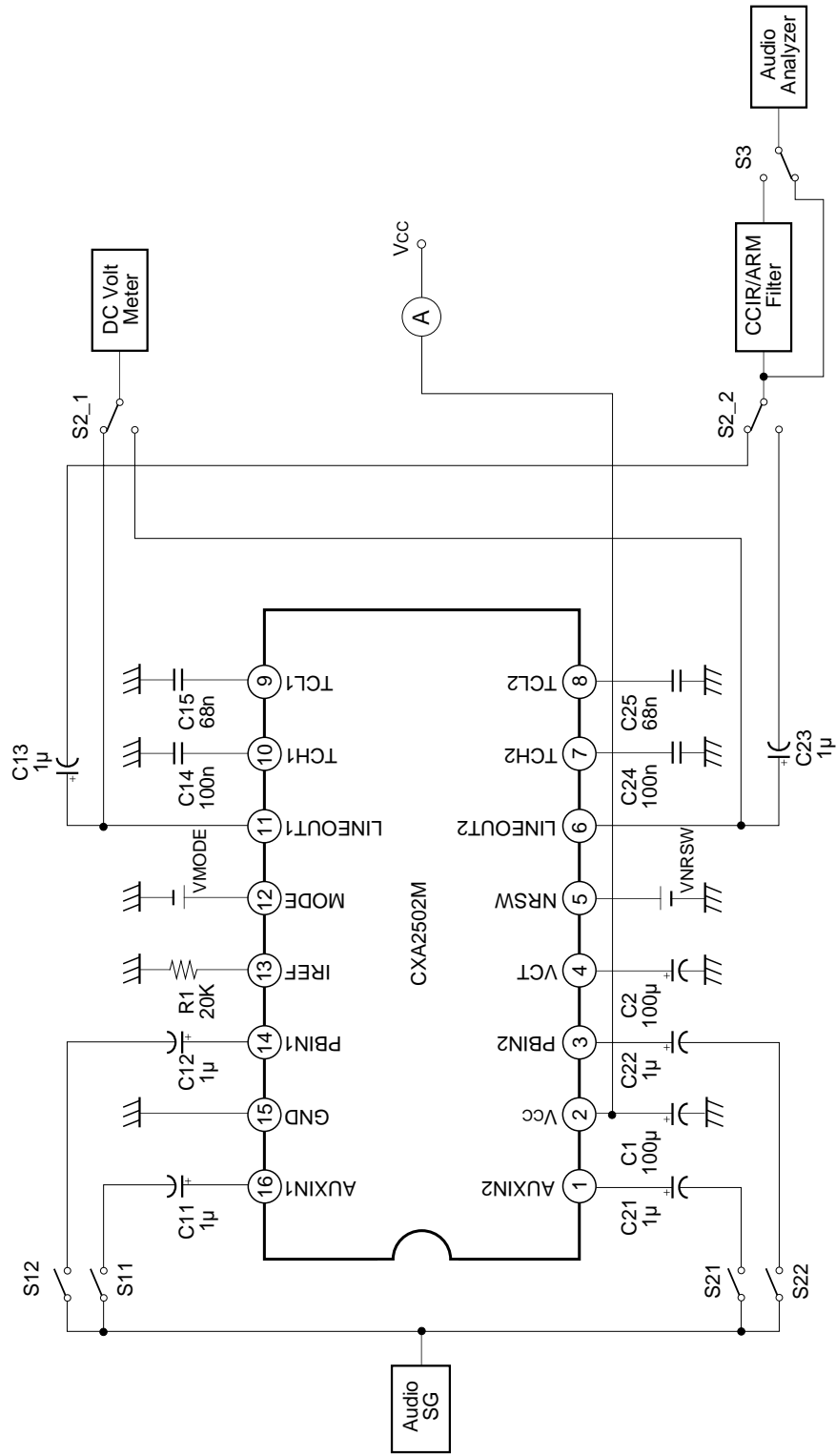

**Application Note**

The CXA2502M is a stereo Dolby B-C type NR IC like the CXA1560 series.

Few external parts and smaller package can be achieved because this IC has a built-in spectral skewing circuit and the reduced number of pins for playback.

1) Power Supply

The CXA2502M is designed to operate on either single or dual power supply.

For dual power supply, connect VCT pin to GND, and GND pin to the negative power supply.

For single power supply, connect GND pin to GND.  $V_{CC}/2$ , generated from the internal circuit, is output to VCT pin.

Connect a by-pass capacitor between this pin and GND.

The operating voltage range is 7.0 to 16V, which satisfies the signal handling of 12dB specified by the Dolby Laboratories.

2) Operation Mode Control

The CXA2502M has built-in electronic switches. The operations are controlled by the DC voltages of NRSW and MODE control pins. Table 1 shows the switching truth tables.

For single power supply, VH, VM and VL correspond to  $V_{CC}$ ,  $V_{CC}/2$  and GND, respectively.

For dual power supply, VH, VM and VL correspond to  $V_{CC}$ , GND and  $V_{EE}$ , respectively.

Refer to "threshold" on the characteristics graph for the thresholds of the control voltages. NRSW and MODE control pins are connected to VCT via a 50kΩ resistor, so when the pin is open, VM condition results.

	VH	VM	VL
NRSW	C type	B type	NR OFF
MODE	→	TAPE	AUX

**Table 1**

3) Reference level

The CXA2502M Dolby level is -6dBm (388mVrms). The reference level of the playback input pin (PB IN) is defined as the levels which provide the line output level to the line output pin (LINE OUT) in NR OFF mode.

Example of Representative Characteristics

Quiescent current consumption vs. Supply voltage

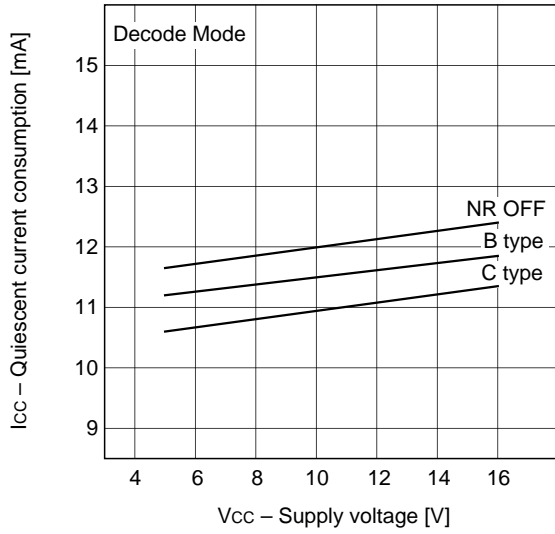

Quiescent current consumption vs. Input level

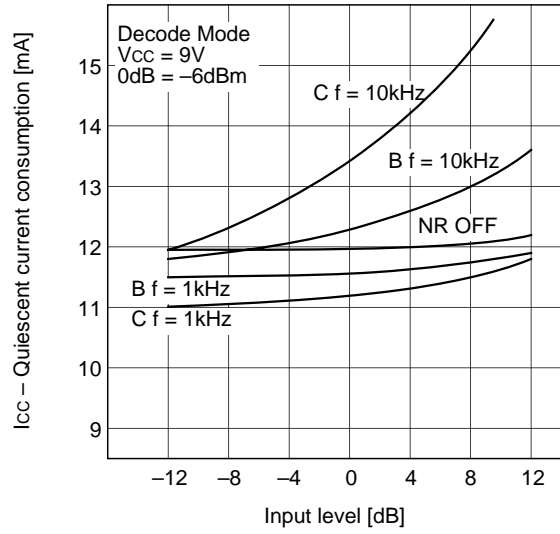

B type decode characteristics

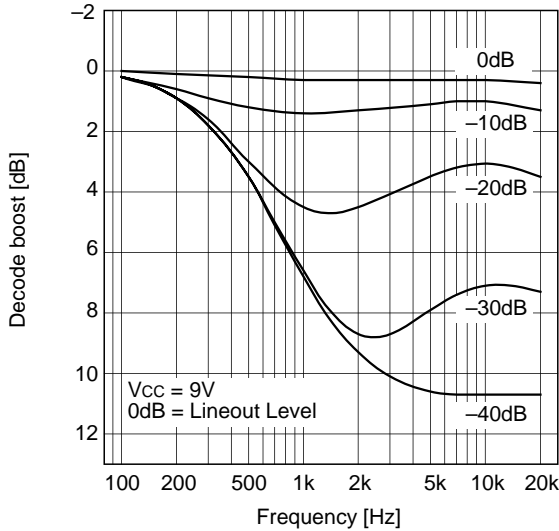

C type decode characteristics

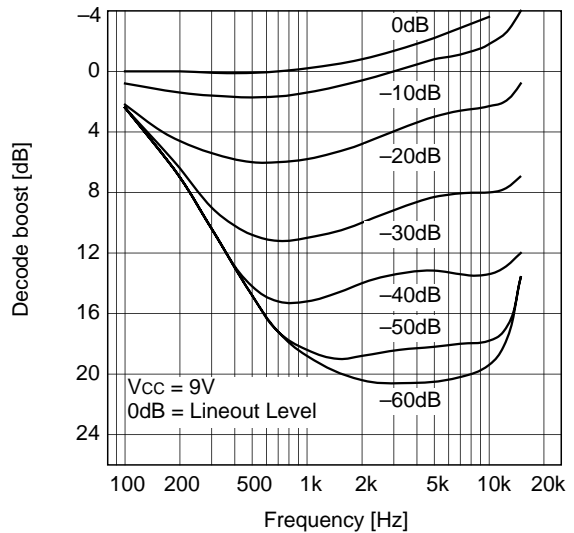

Signal handling

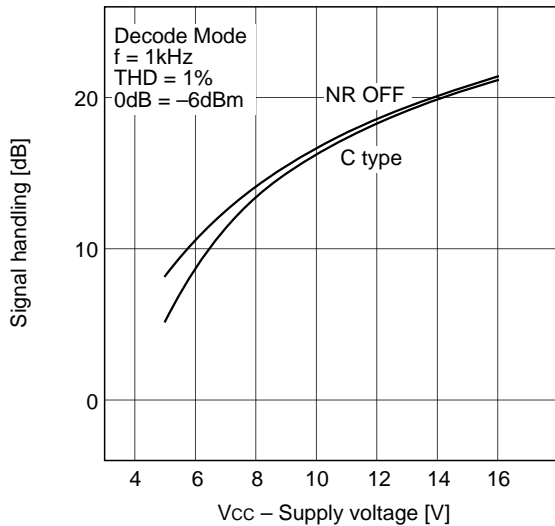

Load characteristics

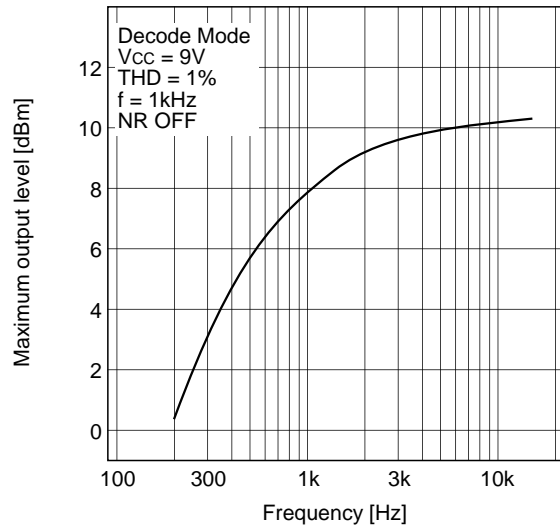



**NR OFF total harmonic distortion-1**

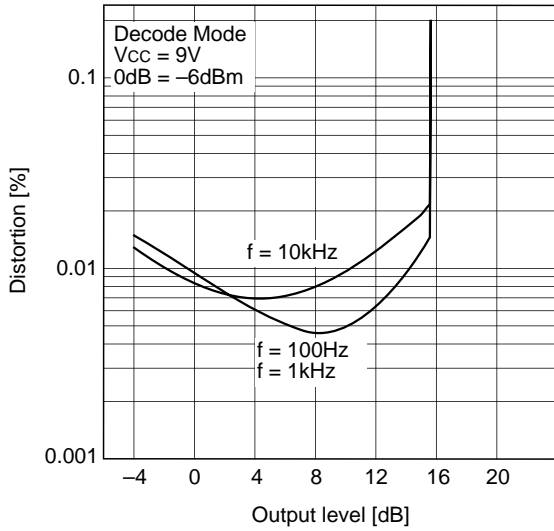

**NR OFF total harmonic distortion-2**

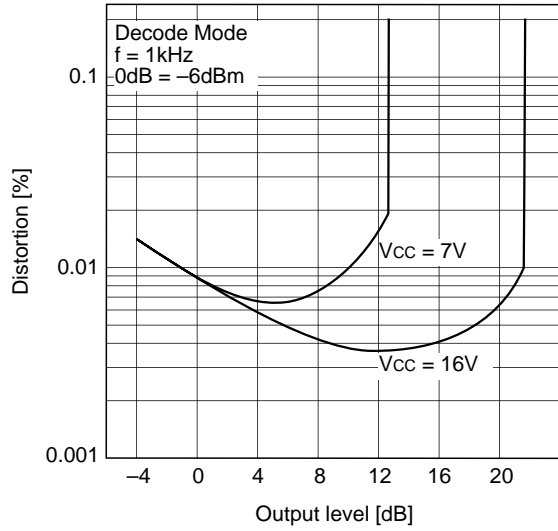

**B type total harmonic distortion-1**

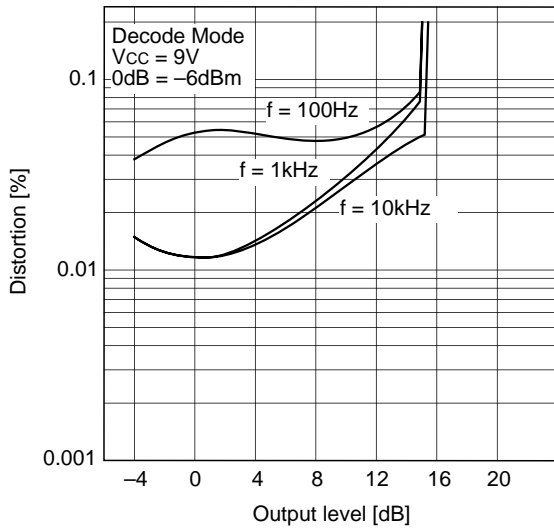

**B type total harmonic distortion-2**

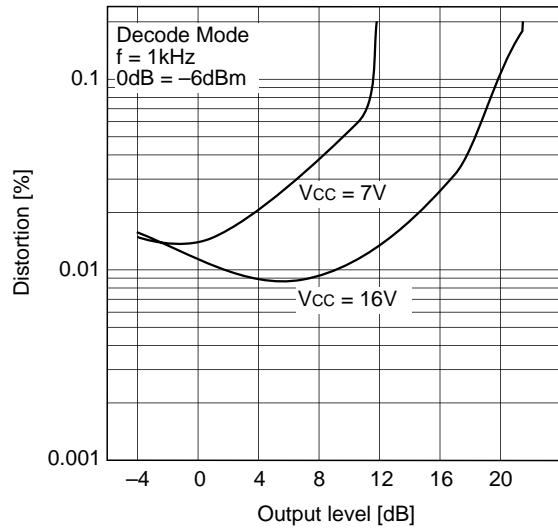

**C type total harmonic distortion-1**

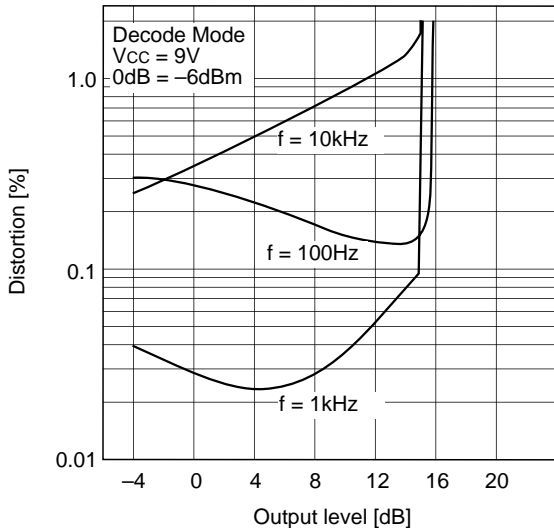

**C type total harmonic distortion-2**

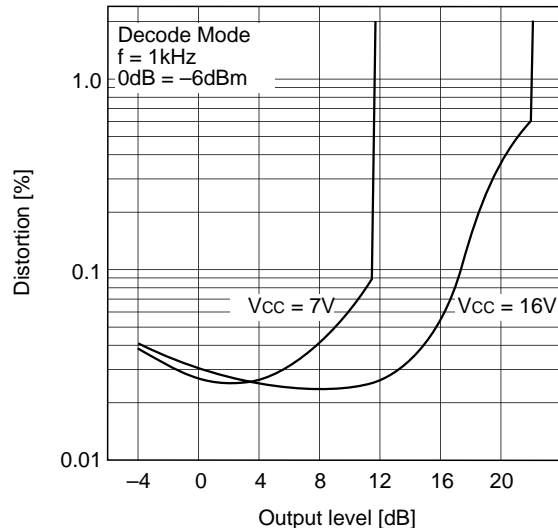

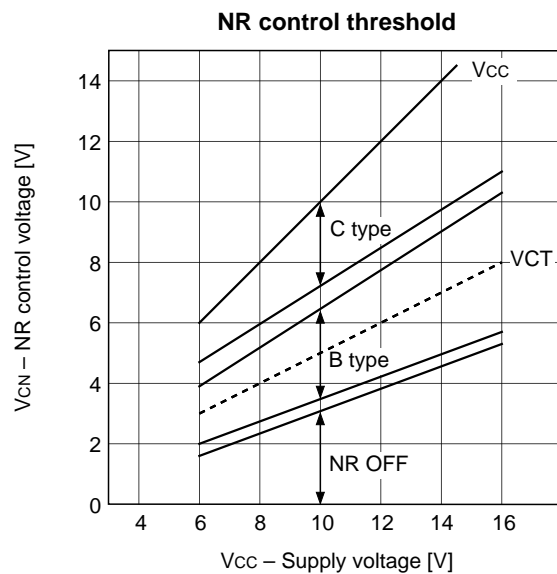
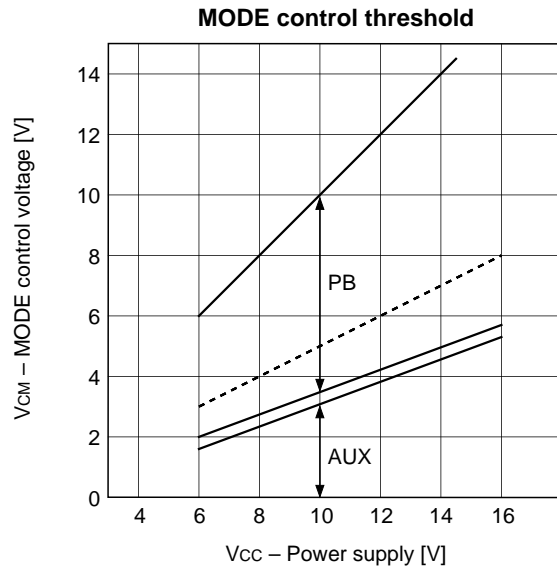
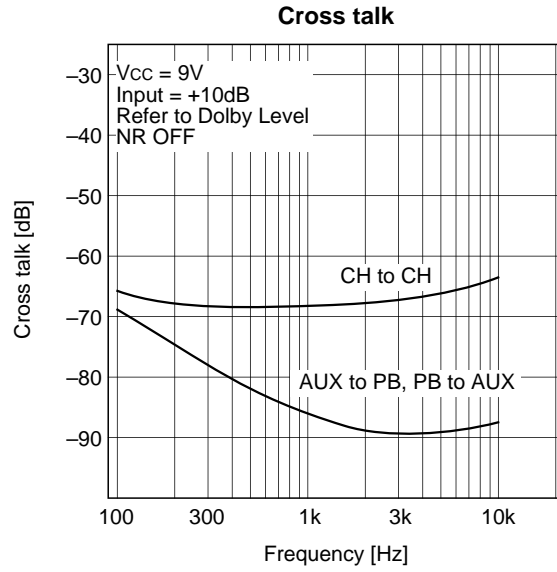

Package Outline

Unit: mm

16PIN SOP (PLASTIC)

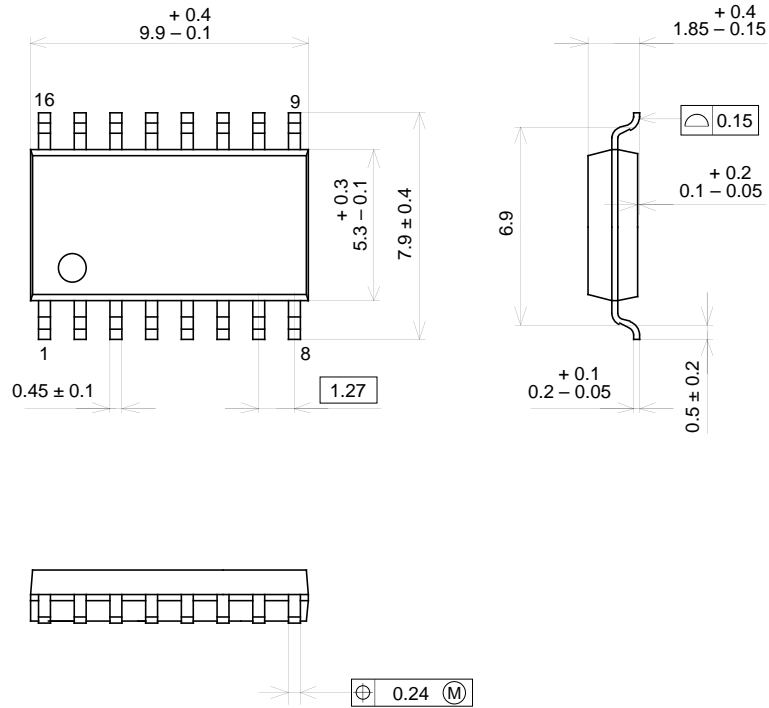

PACKAGE STRUCTURE

SONY CODE	SOP-16P-L01
EIAJ CODE	SOP016-P-0300
JEDEC CODE	

PACKAGE MATERIAL	EPOXY RESIN
LEAD TREATMENT	SOLDER PLATING
LEAD MATERIAL	COPPER ALLOY
PACKAGE MASS	0.2g

LEAD PLATING SPECIFICATIONS

ITEM	SPEC.
LEAD MATERIAL	COPPER ALLOY
SOLDER COMPOSITION	Sn-Bi Bi:1-4wt%
PLATING THICKNESS	5-18 $\mu$ m