





### ● Absolute maximum Ratings

Parameter	Symbol	Ratings	Unit
Vcc Voltage	Vcc	-0.3 to +7 <sup>*1</sup>	V
PVcc Voltage	PVcc	-0.3 to +7 <sup>*1</sup>	V
EN Voltage	VEN	-0.3 to +7	V
SW, ITH Voltage	Vsw, VITH	-0.3 to +7	V
Power Dissipation 1	Pd1	387.5 <sup>*2</sup>	mW
Power Dissipation 2	Pd2	587.4 <sup>*3</sup>	mW
Operating temperature range	Topr	-25 to +85	°C
Storage temperature range	Tstg	-55 to +150	°C
Maximum junction temperature	Tjmax	+150	°C

\*1 Pd should not be exceeded.

\*2 Derating in done 3.1mW/°C for temperatures above Ta=25°C.

\*3 Derating in done 4.7mW/°C for temperatures above Ta=25°C, Mounted on 70mm × 70mm × 1.6mm Glass Epoxy PCB.

### ● Operating Ratings(Ta=25°C)

Parameter	Symbol	Limits			Unit
		Min.	Typ.	Max.	
Vcc Voltage	Vcc <sup>*4</sup>	4.0	5.0	5.5	V
PVcc Voltage	Pvcc <sup>*4</sup>	4.0	5.0	5.5	V
EN Voltage	VEN	0	-	Vcc	V
SW average output current	Isw <sup>*4</sup>	-	-	0.8	A
Output voltage Setting Range	VOUT	1.0	-	2.5	V

\*4 Pd should not be exceeded.

### ● Electrical Characteristics

©(Ta=25°C, Vcc=5V, EN=Vcc, R1=20kΩ, R2=10kΩ unless otherwise specified.)

Parameter	Symbol	Limits			Unit	Conditions
		Min.	Typ.	Max.		
Standby current	ISTB	-	0	10	μA	EN=GND
Bias current	ICC	-	250	450	μA	
EN Low voltage	VENL	-	GND	0.8	V	Standby mode
EN High voltage	VENH	2.0	Vcc	-	V	Active mode
EN input current	IEN	-	1	10	μA	VEN=5V
Oscillation frequency	FOSC	0.8	1	1.2	MHz	
Pch FET ON resistance	RONP	-	350	600	mΩ	Pvcc=5V
Nch FET ON resistance	RONN	-	250	500	mΩ	Pvcc=5V
ADJ voltage	VADJ	0.78	0.80	0.82	V	
ITH sink current	ITHSI	10	20	-	μA	VADJ=H
ITH source current	ITHSO	10	20	-	μA	VADJ=L
UVLO threshold voltage	VUVLO1	3.20	3.40	3.6	V	Vcc=4→0V
UVLO release voltage	VUVLO2	3.25	3.50	3.80	V	Vcc=0→4V
Soft start time	TSS	1.5	3	6	ms	VADJ=H
Timer latch time	TLATCH	0.5	2	3	ms	SCP/TSD operated

● Typical Performance Curves

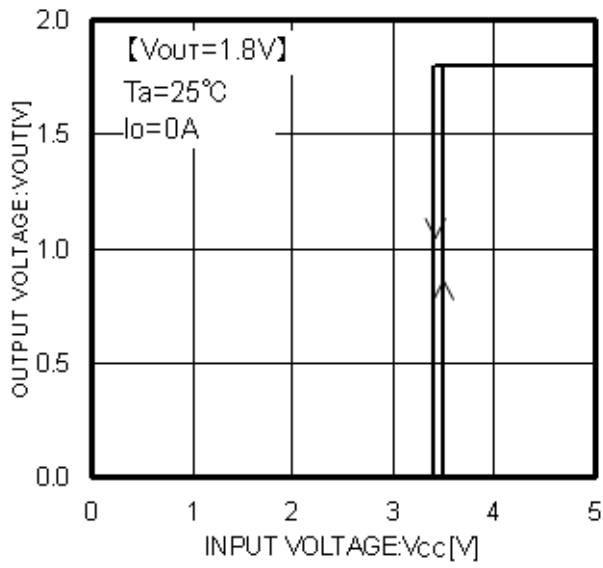

Fig.4 Vcc-Vout

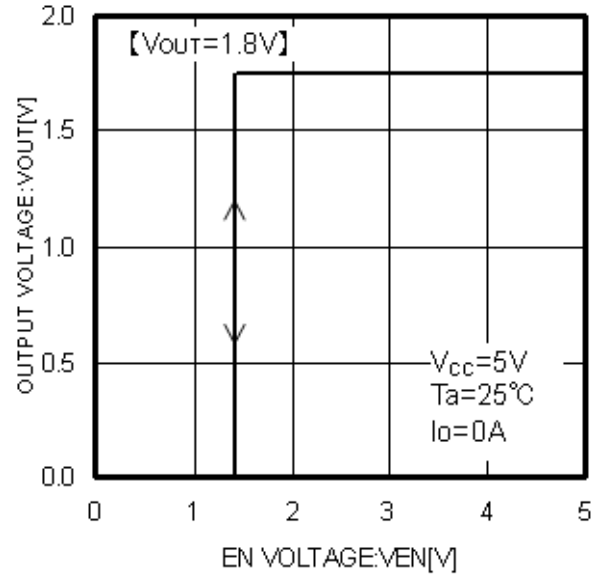

Fig.5 Ven-Vout

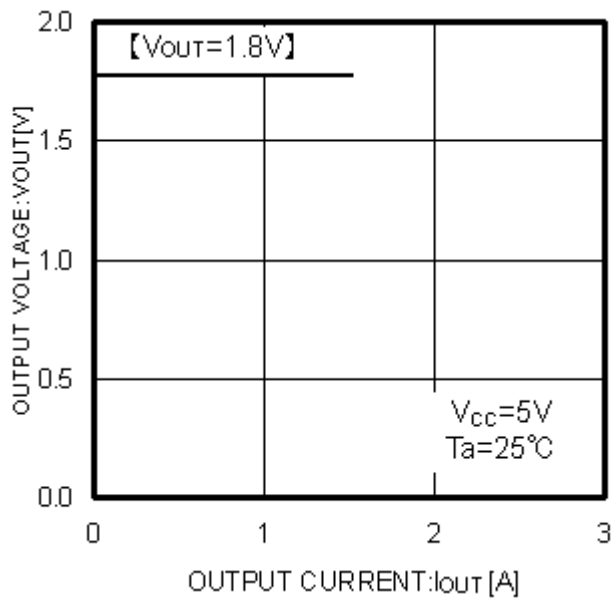

Fig.6 Iout-Vout

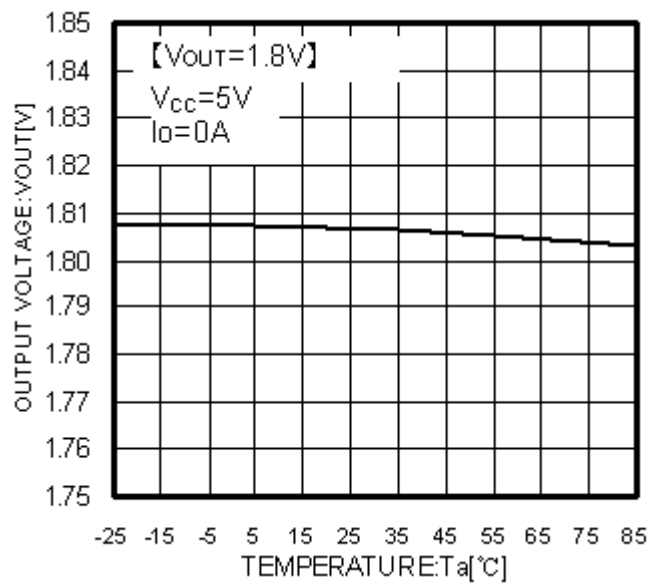

Fig.7 Ta-Vout

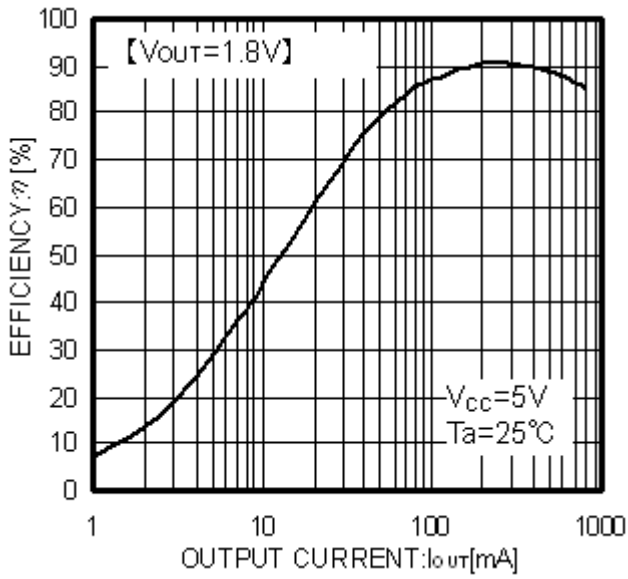

Fig.8 Efficiency

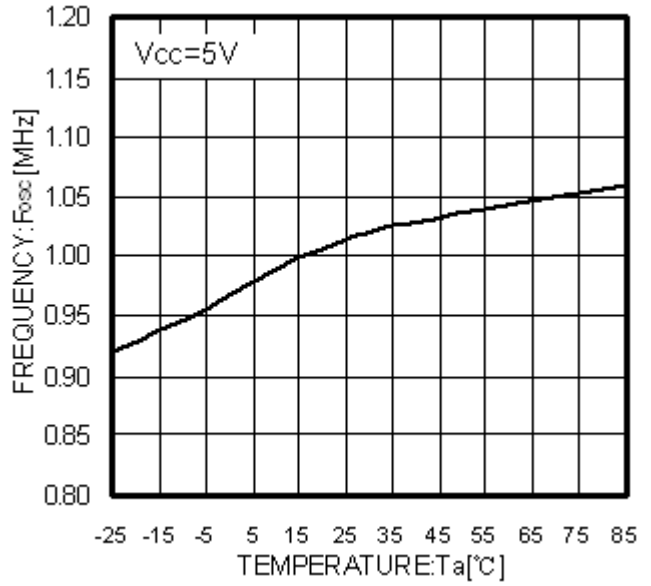

Fig.9 Ta-Fosc

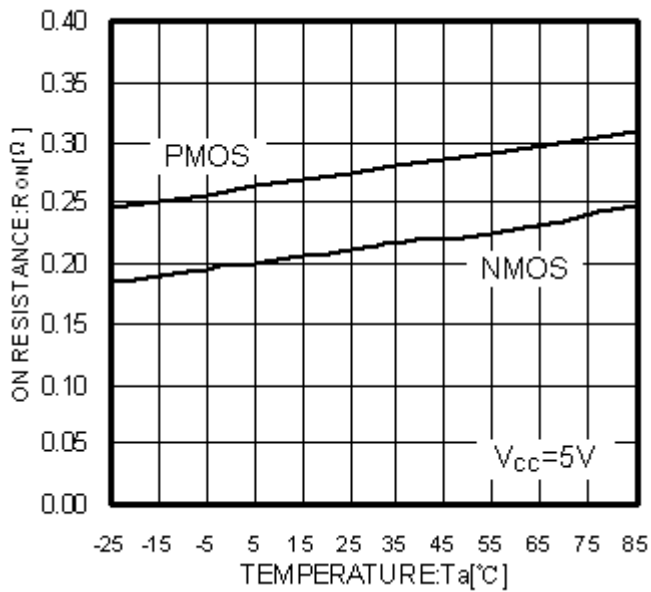

Fig.10 Ta- $R_{ONN}$ ,  $R_{ONP}$

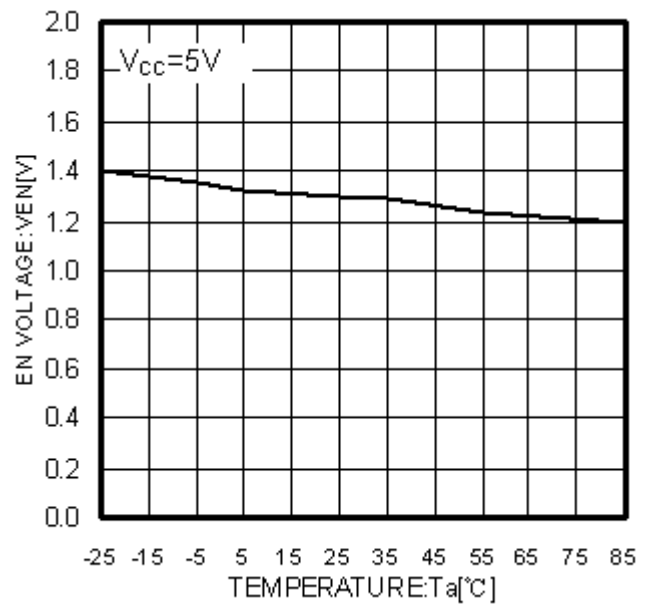

Fig.11 Ta- $V_{EN}$

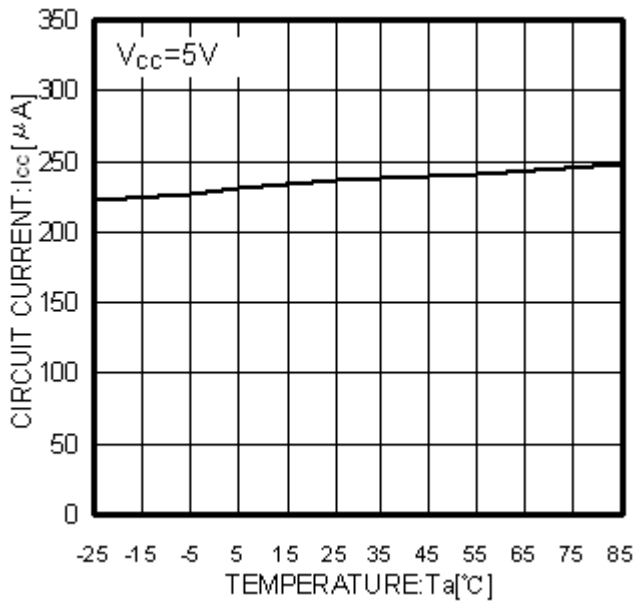

Fig.12 Ta-Icc

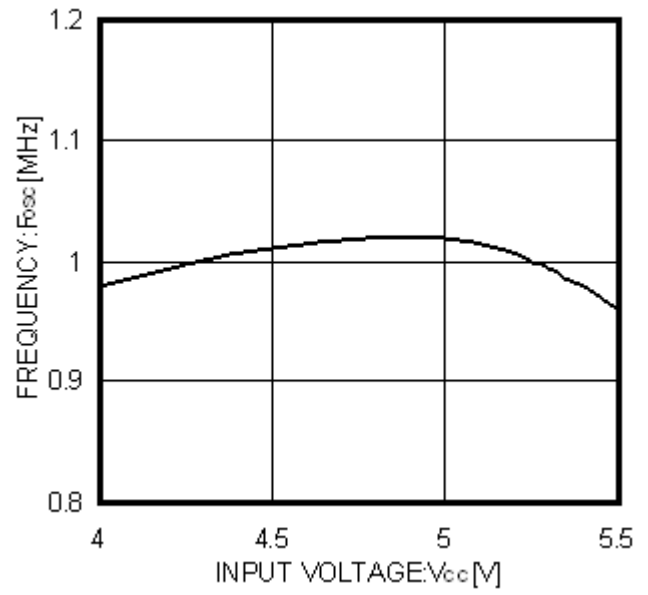

Fig.13 Vcc-Fosc

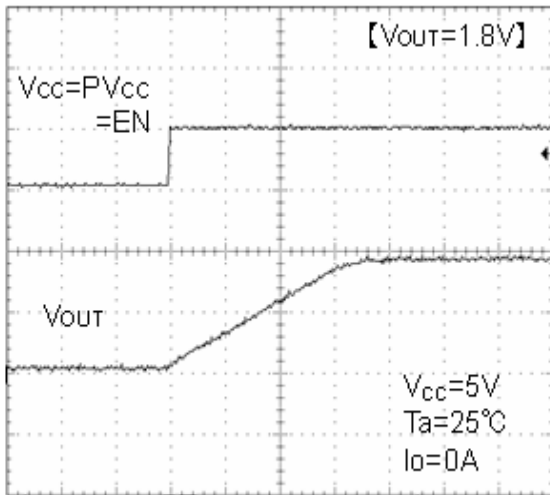

Fig.14 Soft start waveform

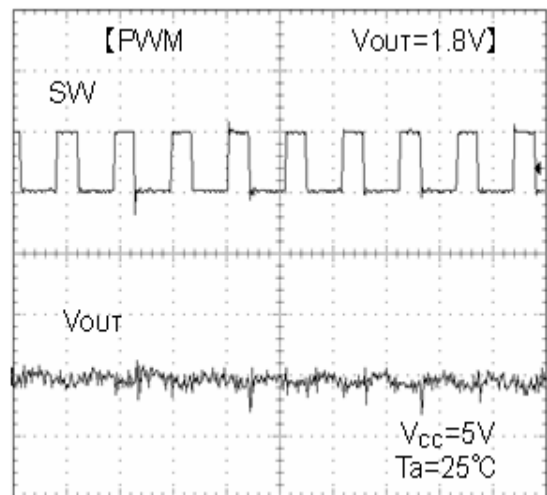

Fig.15 SW waveform

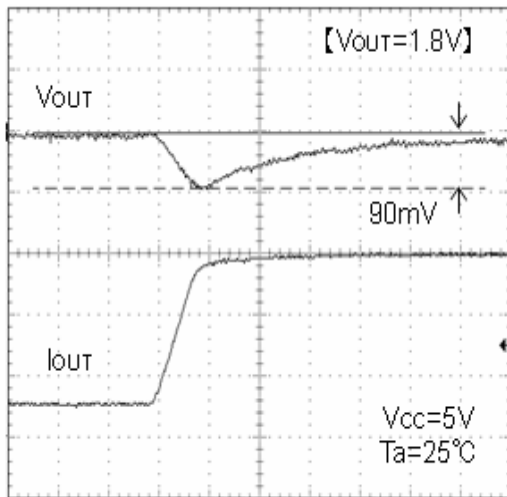

Fig.16 Transient response  
 $I_o=100 \rightarrow 600mA(10\mu s)$

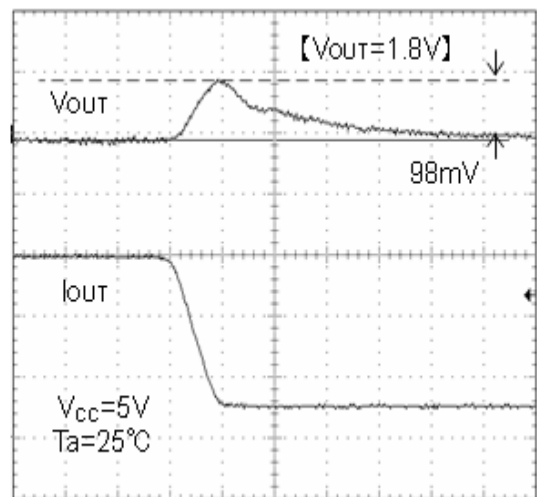

Fig.17 Transient response  
 $I_o=600 \rightarrow 100mA(10\mu s)$

●Application Information

Operation

BD8966FVM is a synchronous rectifying step-down switching regulator that achieves faster transient response by employing current mode PWM control system.

○Synchronous rectifier

It does not require the power to be dissipated by a rectifier externally connected to a conventional DC/DC converter IC, and its P.N junction shoot-through protection circuit limits the shoot-through current during operation, by which the power dissipation of the set is reduced.

○Current mode PWM control

Synthesizes a PWM control signal with a inductor current feedback loop added to the voltage feedback.

- PWM (Pulse Width Modulation) control

The oscillation frequency for PWM is 1 MHz. SET signal from OSC turns ON a P-channel MOS FET (while a N-channel MOS FET is turned OFF), and an inductor current  $I_L$  increases. The current comparator (Current Comp) receives two signals, a current feedback control signal (SENSE: Voltage converted from  $I_L$ ) and a voltage feedback control signal (FB), and issues a RESET signal if both input signals are identical to each other, and turns OFF the P-channel MOS FET (while a N-channel MOS FET is turned ON) for the rest of the fixed period. The PWM control repeats this operation.

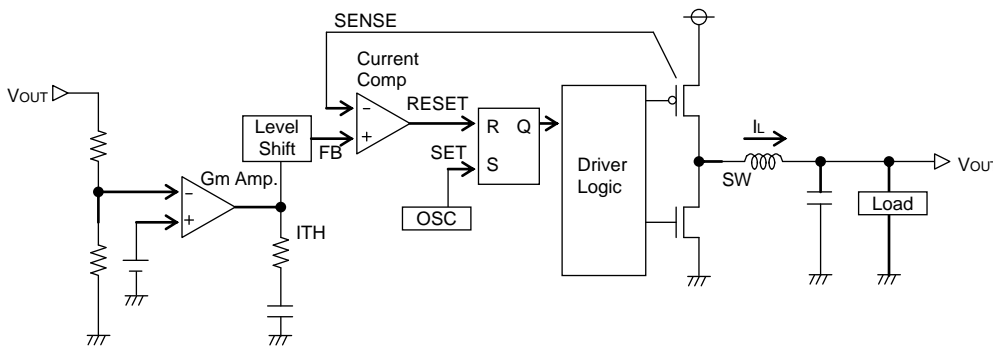

Fig.18 Diagram of current mode PWM control

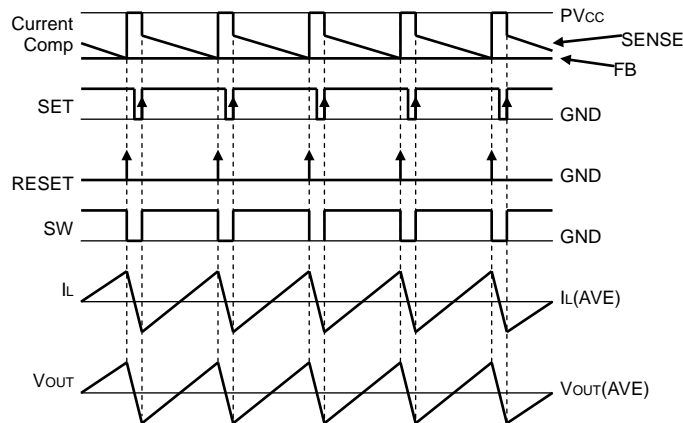

Fig.19 PWM switching timing chart



**Description of Operation**

**Soft-start function**

EN terminal shifted to “High” activates a soft-starter to gradually establish the output voltage with the current limited during startup, by which it is possible to prevent an overshoot of output voltage and an inrush current.

• **Shutdown function**

With EN terminal shifted to “Low”, the device turns to Standby Mode, and all the function blocks including reference voltage circuit, internal oscillator and drivers are turned to OFF. Circuit current during standby is  $0 \mu F$  (Typ.).

• **UVLO function**

Detects whether the input voltage sufficient to secure the output voltage of this IC is supplied. And the hysteresis width of 300mV (Typ.) is provided to prevent output chattering.

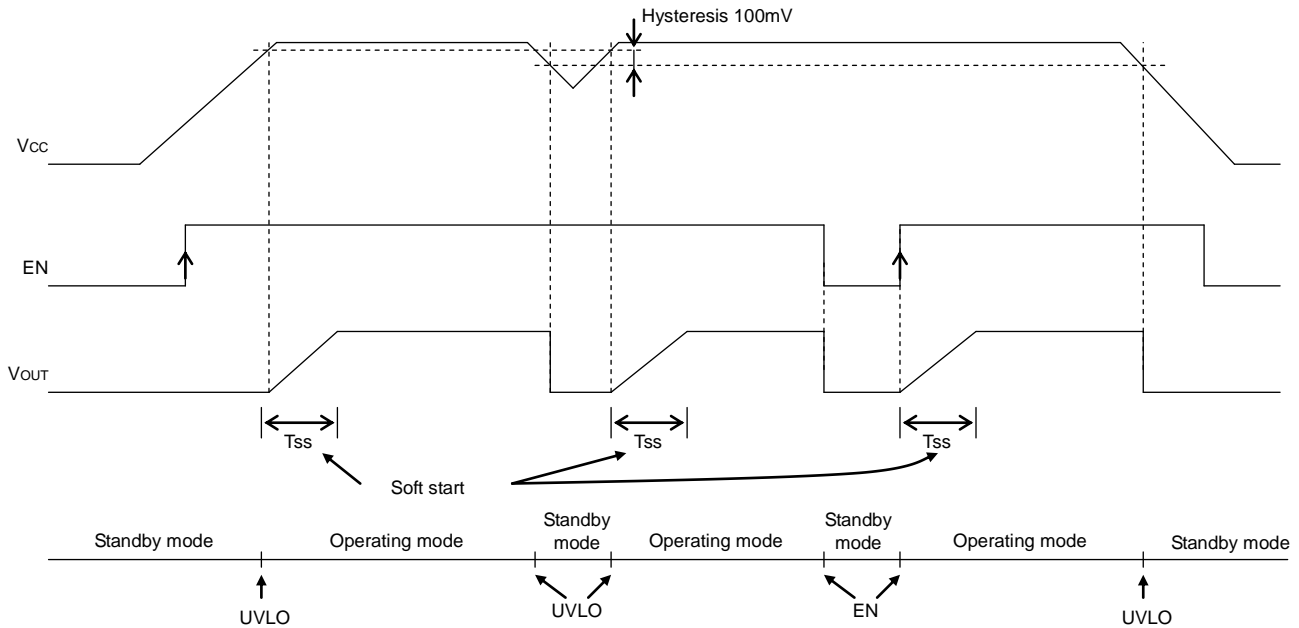

Fig.20 Soft start, Shutdown, UVLO timing chart

• **Short-current protection circuit with time delay function**

Turns OFF the output to protect the IC from breakdown when the incorporated current limiter is activated continuously for at least 1 ms. The output thus held tuned OFF may be recovered by restarting EN or by re-unlocking UVLO.

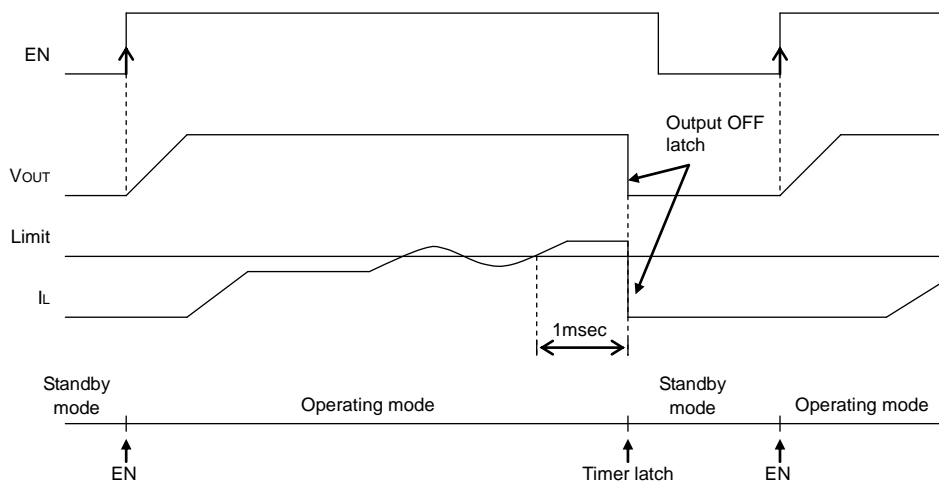
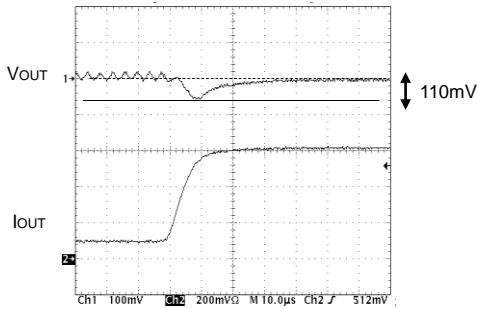

Fig.21 Short-current protection circuit with time delay timing chart

**Information on Advantages**

Advantage 1: Offers fast transient response with current mode control system.

Conventional product (Load response  $I_o=0.1A \rightarrow 0.6A$ )



BD8966FVM (Load response  $I_o=0.1A \rightarrow 0.6A$ )

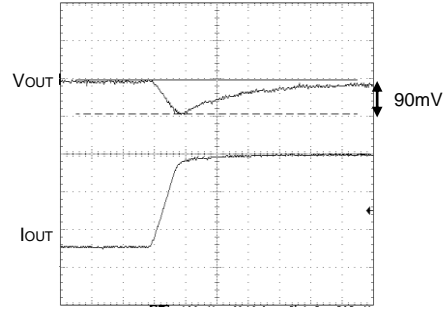

Voltage drop due to sudden change in load was reduced.

Fig.22 Comparison of transient response

Advantage 2: Offers high efficiency with synchronous rectifier

- For heavier load:  
Utilizes the synchronous rectifying mode and the low on-resistance MOS FETs incorporated as power transistor.

- { ON resistance of P-channel MOS FET : 350mΩ(Typ.)
- { ON resistance of N-channel MOS FET : 250mΩ(Typ.)

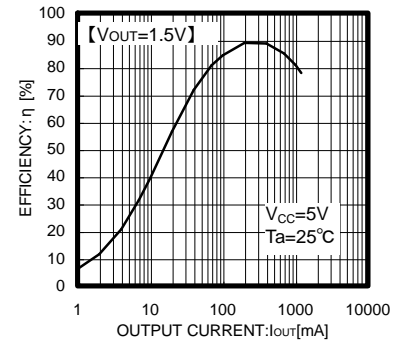

Fig.23

Advantage 3: • Supplied in smaller package due to small-sized power MOS FET incorporated.

- Output capacitor  $C_o$  required for current mode control: 10μF ceramic capacitor
- Inductance  $L$  required for the operating frequency of 1 MHz: 4.7μH inductor

Reduces a mounting area required.

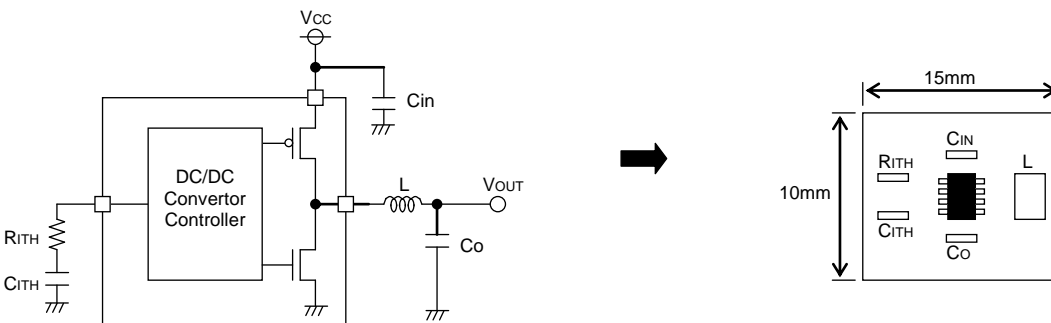

Fig.24 Example application

### Switching Regulator Efficiency

Efficiency  $\eta$  may be expressed by the equation shown below:

$$\eta = \frac{V_{OUT} \times I_{OUT}}{V_{IN} \times I_{IN}} \times 100[\%] = \frac{P_{OUT}}{P_{IN}} \times 100[\%] = \frac{P_{OUT}}{P_{OUT} + P_{D\alpha}} \times 100[\%]$$

Efficiency may be improved by reducing the switching regulator power dissipation factors  $P_{D\alpha}$  as follows:

Dissipation factors:

- 1) ON resistance dissipation of inductor and FET:  $P_D(I^2R)$
- 2) Gate charge/discharge dissipation:  $P_D(\text{Gate})$
- 3) Switching dissipation:  $P_D(\text{SW})$
- 4) ESR dissipation of capacitor:  $P_D(\text{ESR})$
- 5) Operating current dissipation of IC:  $P_D(\text{IC})$

1)  $P_D(I^2R) = I_{OUT}^2 \times (R_{COIL} + R_{ON})$  ( $R_{COIL}[\Omega]$ : DC resistance of inductor,  $R_{ON}[\Omega]$ : ON resistance of FET,  $I_{OUT}[\text{A}]$ : Output current.)

2)  $P_D(\text{Gate}) = C_{GS} \times f \times V$  ( $C_{GS}[\text{F}]$ : Gate capacitance of FET,  $f[\text{Hz}]$ : Switching frequency,  $V[\text{V}]$ : Gate driving voltage of FET)

3)  $P_D(\text{SW}) = \frac{V_{IN}^2 \times C_{RSS} \times I_{OUT} \times f}{I_{DRIVE}}$  ( $C_{RSS}[\text{F}]$ : Reverse transfer capacitance of FET,  $I_{DRIVE}[\text{A}]$ : Peak current of gate.)

4)  $P_D(\text{ESR}) = I_{RMS}^2 \times \text{ESR}$  ( $I_{RMS}[\text{A}]$ : Ripple current of capacitor,  $\text{ESR}[\Omega]$ : Equivalent series resistance.)

5)  $P_D(\text{IC}) = V_{IN} \times I_{CC}$  ( $I_{CC}[\text{A}]$ : Circuit current.)

### Consideration on Permissible Dissipation and Heat Generation

As this IC functions with high efficiency without significant heat generation in most applications, no special consideration is needed on permissible dissipation or heat generation. In case of extreme conditions, however, including lower input voltage, higher output voltage, heavier load, and/or higher temperature, the permissible dissipation and/or heat generation must be carefully considered.

For dissipation, only conduction losses due to DC resistance of inductor and ON resistance of FET are considered. Because the conduction losses are considered to play the leading role among other dissipation mentioned above including gate charge/discharge dissipation and switching dissipation.

$$P = I_{OUT}^2 \times (R_{COIL} + R_{ON})$$

$$R_{ON} = D \times R_{ONP} + (1-D) \times R_{ONN}$$

D: ON duty (=  $V_{OUT}/V_{CC}$ )

$R_{COIL}$ : DC resistance of coil

$R_{ONP}$ : ON resistance of P-channel MOS FET

$R_{ONN}$ : ON resistance of N-channel MOS FET

$I_{OUT}$ : Output current

If  $V_{CC}=5\text{V}$ ,  $V_{OUT}=1.5\text{V}$ ,  $R_{COIL}=0.15\Omega$ ,  $R_{ONP}=0.35\Omega$ ,  $R_{ONN}=0.25\Omega$

$I_{OUT}=0.8\text{A}$ , for example,

$$D = V_{OUT}/V_{CC} = 1.5/5 = 0.3$$

$$R_{ON} = 0.3 \times 0.35 + (1-0.3) \times 0.25$$

$$= 0.105 + 0.175$$

$$= 0.28[\Omega]$$

$$P = 0.8^2 \times (0.15 + 0.28)$$

$$\doteq 275.2[\text{mW}]$$

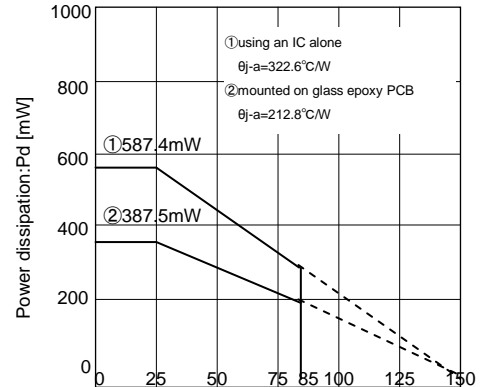

Fig. 25

As  $R_{ONP}$  is greater than  $R_{ONN}$  in this IC, the dissipation increases as the ON duty becomes greater. With the consideration on the dissipation as above, thermal design must be carried out with sufficient margin allowed.

**Selection of Components Externally Connected**

**1. Selection of inductor (L)**

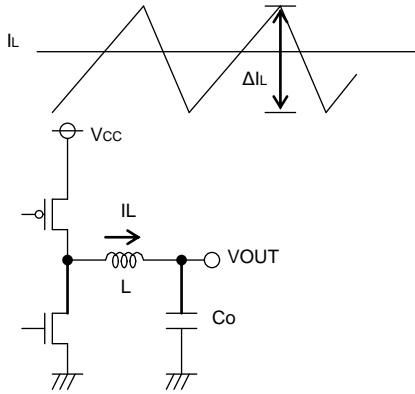

Fig.26 Output ripple current

The inductance significantly depends on output ripple current. As seen in the equation (1), the ripple current decreases as the inductor and/or switching frequency increases.

$$\Delta I_L = \frac{(V_{CC} - V_{OUT}) \times V_{OUT}}{L \times V_{CC} \times f} \quad [A] \dots (1)$$

Appropriate ripple current at output should be 30% more or less of the maximum output current.

$$\Delta I_L = 0.3 \times I_{OUTmax} \quad [A] \dots (2)$$

$$L = \frac{(V_{CC} - V_{OUT}) \times V_{OUT}}{\Delta I_L \times V_{CC} \times f} \quad [H] \dots (3)$$

( $\Delta I_L$ : Output ripple current, and  $f$ : Switching frequency)

- \* Current exceeding the current rating of the inductor results in magnetic saturation of the inductor, which decreases efficiency. The inductor must be selected allowing sufficient margin with which the peak current may not exceed its current rating.

If  $V_{CC}=5V$ ,  $V_{OUT}=1.5V$ ,  $f=1MHz$ ,  $\Delta I_L=0.3 \times 0.8A=0.24A$ , for example,

$$L = \frac{(5-1.5) \times 1.5}{0.24 \times 5 \times 1M} = 4.375\mu \rightarrow 4.7[\mu H]$$

- \* Select the inductor of low resistance component (such as DCR and ACR) to minimize dissipation in the inductor for better efficiency.

**2. Selection of output capacitor (Co)**

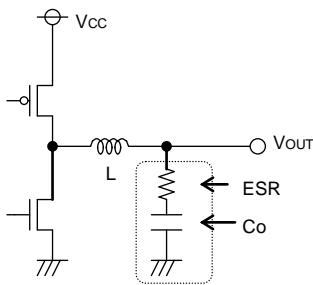

Fig.27 Output capacitor

Output capacitor should be selected with the consideration on the stability region and the equivalent series resistance required to smooth ripple voltage. Output ripple voltage is determined by the equation (4) :

$$\Delta V_{OUT} = \Delta I_L \times ESR \quad [V] \dots (4)$$

( $\Delta I_L$ : Output ripple current, ESR: Equivalent series resistance of output capacitor)

\*Rating of the capacitor should be determined allowing sufficient margin against output voltage. Less ESR allows reduction in output ripple voltage.

As the output rise time must be designed to fall within the soft-start time, the capacitance of output capacitor should be determined with consideration on the requirements of equation (5):

$$C_o \leq \frac{T_{SS} \times (I_{limit} - I_{OUT})}{V_{OUT}} \dots (5) \quad \left[ \begin{array}{l} T_{SS}: \text{Soft-start time} \\ I_{limit}: \text{Over current detection level, 2A(Typ)} \end{array} \right]$$

In case of BD8966FVM, for instance, and if  $V_{OUT}=1.5V$ ,  $I_{OUT}=0.8A$ , and  $T_{SS}=1ms$ ,

$$C_o \leq \frac{1m \times (2-0.8)}{1.5} \approx 800[\mu F]$$

Inappropriate capacitance may cause problem in startup. A 10  $\mu F$  to 100  $\mu F$  ceramic capacitor is recommended.

3. Selection of input capacitor (Cin)

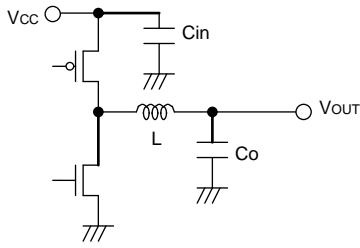

Fig.28 Input capacitor

Input capacitor to select must be a low ESR capacitor of the capacitance sufficient to cope with high ripple current to prevent high transient voltage. The ripple current IRMS is given by the equation (5):

$$I_{RMS} = I_{OUT} \times \frac{\sqrt{V_{OUT}(V_{CC}-V_{OUT})}}{V_{CC}} \quad [A] \dots (5)$$

< Worst case > IRMS(max.)

When VCC is twice the VOUT,  $I_{RMS} = \frac{I_{OUT}}{2}$

If VCC=5.0V, VOUT=1.5V, and IOUTmax.=0.8A

$$I_{RMS} = 0.8 \times \frac{\sqrt{5(5-1.5)}}{5} = 0.67[A_{RMS}]$$

A low ESR 10μF/10V ceramic capacitor is recommended to reduce ESR dissipation of input capacitor for better efficiency.

4. Determination of RITH, CITH that works as a phase compensator

As the Current Mode Control is designed to limit a inductor current, a pole (phase lag) appears in the low frequency area due to a CR filter consisting of a output capacitor and a load resistance, while a zero (phase lead) appears in the high frequency area due to the output capacitor and its ESR. So, the phases are easily compensated by adding a zero to the power amplifier output with C and R as described below to cancel a pole at the power amplifier.

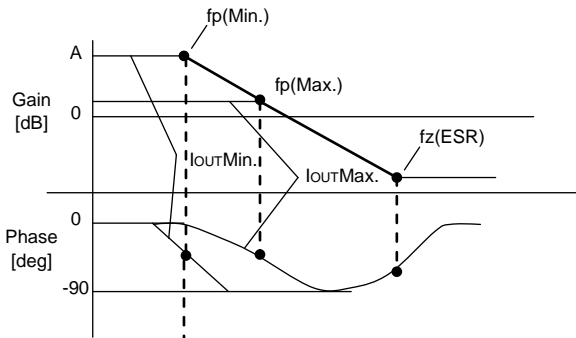

Fig.29 Open loop gain characteristics

$$f_p = \frac{1}{2\pi \times R_o \times C_o}$$

$$f_z(ESR) = \frac{1}{2\pi \times ESR \times C_o}$$

Pole at power amplifier

When the output current decreases, the load resistance Ro increases and the pole frequency lowers.

$$f_{p(Min.)} = \frac{1}{2\pi \times R_{OMax.} \times C_o} \quad [Hz] \leftarrow \text{with lighter load}$$

$$f_{p(Max.)} = \frac{1}{2\pi \times R_{OMin.} \times C_o} \quad [Hz] \leftarrow \text{with heavier load}$$

Zero at power amplifier

Increasing capacitance of the output capacitor lowers the pole frequency while the zero frequency does not change.

(This is because when the capacitance is doubled, the capacitor ESR reduces to half.)

$$f_z(Amp.) = \frac{1}{2\pi \times R_{ITH} \times C_{ITH}}$$

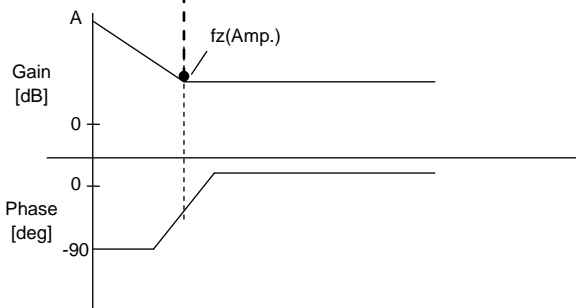

Fig.30 Error amp phase compensation characteristics

Stable feedback loop may be achieved by canceling the pole fp (Min.) produced by the output capacitor and the load resistance with CR zero correction by the error amplifier.

$$f_z(\text{Amp.}) = f_p(\text{Min.})$$

$$\rightarrow \frac{1}{2\pi \times R_{ITH} \times C_{ITH}} = \frac{1}{2\pi \times R_{O\text{Max.}} \times C_O}$$

5. Determination of output voltage

The output voltage VOUT is determined by the equation (7):

$$V_{OUT} = (R_2/R_1 + 1) \times V_{ADJ} \dots (7) \quad V_{ADJ}: \text{Voltage at ADJ terminal (0.8V Typ.)}$$

With R1 and R2 adjusted, the output voltage may be determined as required. (Adjustable output voltage range: 1.0V to 2.5V)

Use 1 kΩ to 100 kΩ resistor for R1. If a resistor of the resistance higher than 100 kΩ is used, check the assembled set carefully for ripple voltage etc.

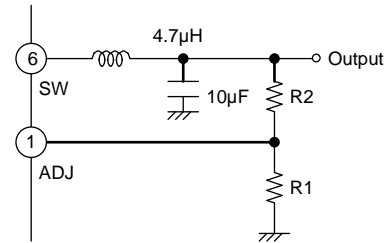

Fig.31 Determination of output voltage

BD8966FVM Cautions on PC Board Layout

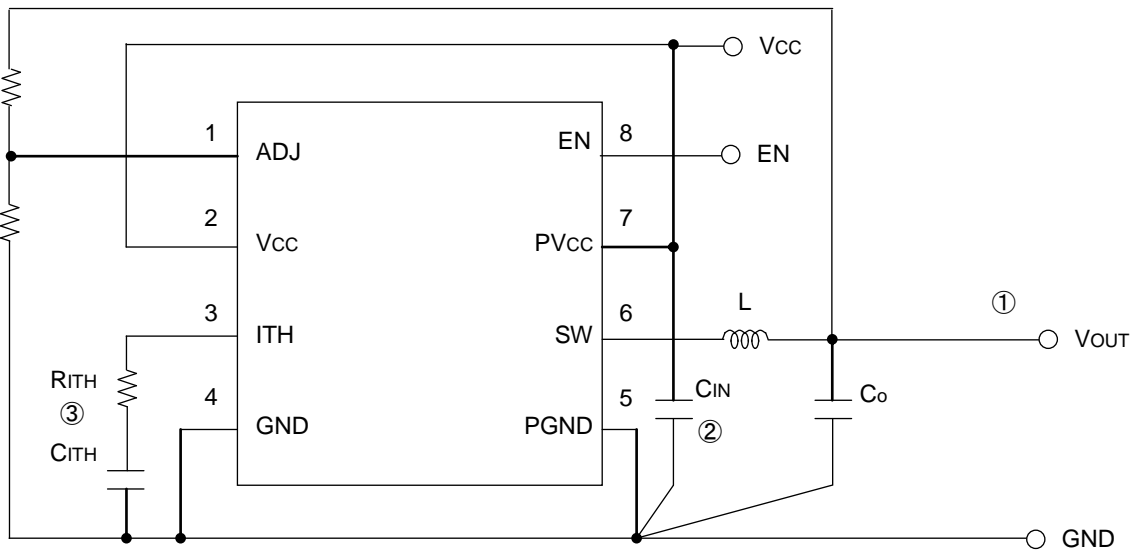

Fig.32 Layout diagram

- ① For the sections drawn with heavy line, use thick conductor pattern as short as possible.
- ② Lay out the input ceramic capacitor CIN closer to the pins PVCC and PGND, and the output capacitor Co closer to the pin PGND.
- ③ Lay out CITH and RITH between the pins ITH and GND as near as possible with least necessary wiring.

**Recommended Components Lists on Above Application**

Symbol	Part	Value	Manufacturer	Series	
L	Coil	4.7μH	Sumida	CMD6D11B	
			TDK	VLF5014AT-4R7M1R1	
CIN	Ceramic capacitor	10μF	Kyocera	CM316X5R106K10A	
Co	Ceramic capacitor	10μF	Kyocera	CM316X5R106K10A	
CITH	Ceramic capacitor	750pF	murata	GRM18series	
RITH	Resistance	V <sub>OUT</sub> =1.0V	18kΩ	ROHM	MCR10 1802
		V <sub>OUT</sub> =1.2V	22kΩ	ROHM	MCR10 2202
		V <sub>OUT</sub> =1.5V	22kΩ	ROHM	MCR10 2202
		V <sub>OUT</sub> =1.8V	27kΩ	ROHM	MCR10 2702
		V <sub>OUT</sub> =2.5V	36kΩ	ROHM	MCR10 3602

\* The parts list presented above is an example of recommended parts. Although the parts are sound, actual circuit characteristics should be checked on your application carefully before use. Be sure to allow sufficient margins to accommodate variations between external devices and this IC when employing the depicted circuit with other circuit constants modified. Both static and transient characteristics should be considered in establishing these margins. When switching noise is substantial and may impact the system, a low pass filter should be inserted between the VCC and PVCC pins, and a schottky barrier diode established between the SW and PGND pins.

**I/O Equivalence Circuit**

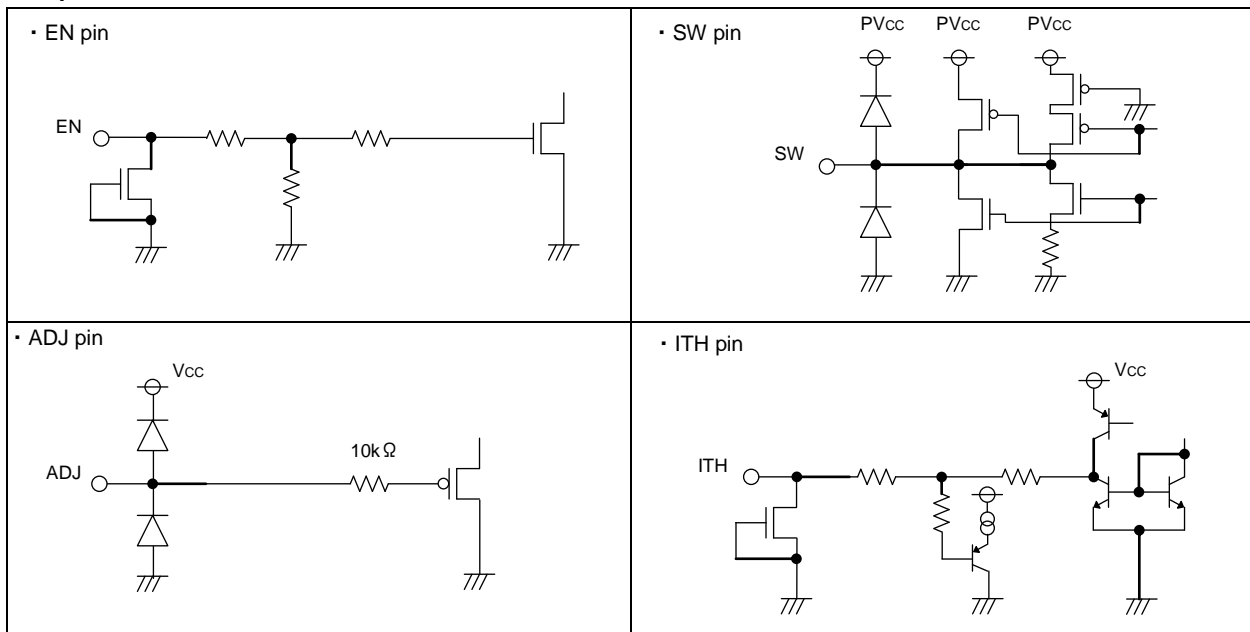

Fig.33 I/O equivalence circuit

## ●Operational Notes

### 1. Absolute Maximum Ratings

While utmost care is taken to quality control of this product, any application that may exceed some of the absolute maximum ratings including the voltage applied and the operating temperature range may result in breakage. If broken, short-mode or open-mode may not be identified. So if it is expected to encounter with special mode that may exceed the absolute maximum ratings, it is requested to take necessary safety measures physically including insertion of fuses.

### 2. Electrical potential at GND

GND must be designed to have the lowest electrical potential In any operating conditions.

### 3. Short-circuiting between terminals, and mismounting

When mounting to pc board, care must be taken to avoid mistake in its orientation and alignment. Failure to do so may result in IC breakdown. Short-circuiting due to foreign matters entered between output terminals, or between output and power supply or GND may also cause breakdown.

### 4. Operation in Strong electromagnetic field

Be noted that using the IC in the strong electromagnetic radiation can cause operation failures.

### 5. Thermal shutdown protection circuit

Thermal shutdown protection circuit is the circuit designed to isolate the IC from thermal runaway, and not intended to protect and guarantee the IC. So, the IC the thermal shutdown protection circuit of which is once activated should not be used thereafter for any operation originally intended.

### 6. Inspection with the IC set to a pc board

If a capacitor must be connected to the pin of lower impedance during inspection with the IC set to a pc board, the capacitor must be discharged after each process to avoid stress to the IC. For electrostatic protection, provide proper grounding to assembling processes with special care taken in handling and storage. When connecting to jigs in the inspection process, be sure to turn OFF the power supply before it is connected and removed.

### 7. Input to IC terminals

This is a monolithic IC with P<sup>+</sup> isolation between P-substrate and each element as illustrated below. This P-layer and the N-layer of each element form a P-N junction, and various parasitic element are formed.

If a resistor is joined to a transistor terminal as shown in Fig 34.

OP-N junction works as a parasitic diode if the following relationship is satisfied; GND>Terminal A (at resistor side), or GND>Terminal B (at transistor side); and

○if GND>Terminal B (at NPN transistor side),

a parasitic NPN transistor is activated by N-layer of other element adjacent to the above-mentioned parasitic diode.

The structure of the IC inevitably forms parasitic elements, the activation of which may cause interference among circuits, and/or malfunctions contributing to breakdown. It is therefore requested to take care not to use the device in such manner that the voltage lower than GND (at P-substrate) may be applied to the input terminal, which may result in activation of parasitic elements.

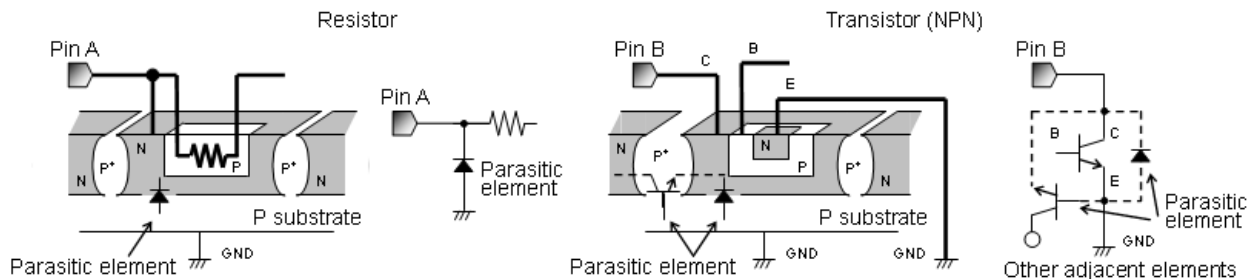

Fig.34 Simplified structure of monolithic IC

### 8. Ground wiring pattern

If small-signal GND and large-current GND are provided, It will be recommended to separate the large-current GND pattern from the small-signal GND pattern and establish a single ground at the reference point of the set PCB so that resistance to the wiring pattern and voltage fluctuations due to a large current will cause no fluctuations in voltages of the small-signal GND. Pay attention not to cause fluctuations in the GND wiring pattern of external parts as well.

### 9. Selection of inductor

It is recommended to use an inductor with a series resistance element (DCR) 0.1Ω or less. Note that use of a high DCR inductor will cause an inductor loss, resulting in decreased output voltage. Should this condition continue for a specified period (soft start time + timer latch time), output short circuit protection will be activated and output will be latched OFF. When using an inductor over 0.1Ω, be careful to ensure adequate margins for variation between external devices and this IC, including transient as well as static characteristics. Furthermore, in any case, it is recommended to start up the output with EN after supply voltage is within operation range.

#### Status of this document

The Japanese version of this document is formal specification. A customer may use this translation version only for a reference to help reading the formal version.

If there are any differences in translation version of this document formal version takes priority



● Ordering Information

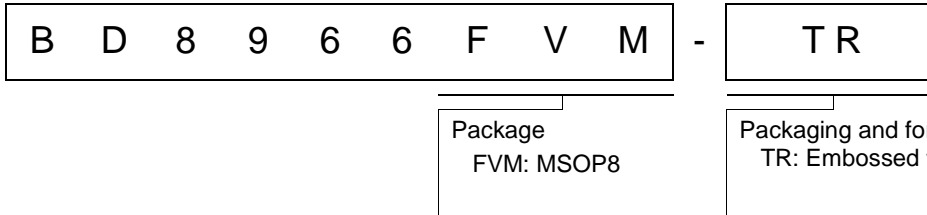

● Physical Dimension, Tape and Reel information

**MSOP8**

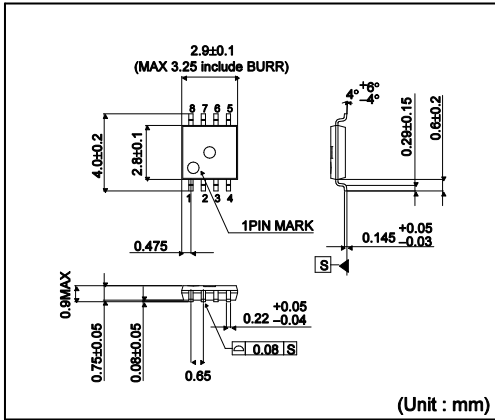

(Unit : mm)

<Tape and Reel information>

Tape	Embossed carrier tape
Quantity	3000pcs
Direction of feed	TR (The direction is the 1pin of product is at the upper right when you hold reel on the left hand and you pull out the tape on the right hand)

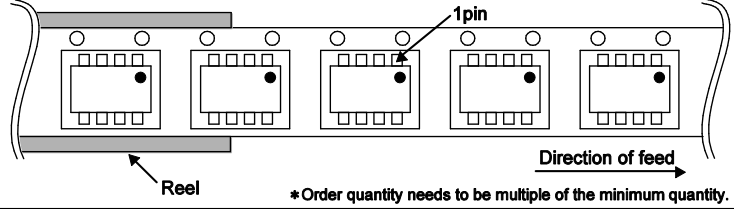

\* Order quantity needs to be multiple of the minimum quantity.

● Marking Diagram

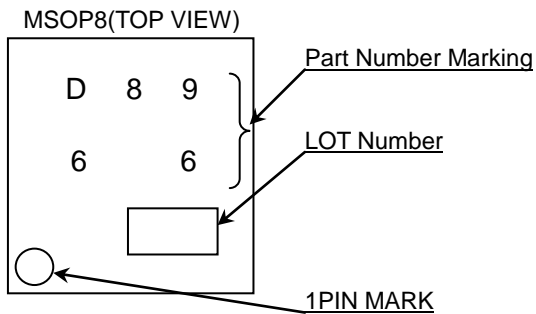

# Notice

## ●Precaution for circuit design

- 1) The products are designed and produced for application in ordinary electronic equipment (AV equipment, OA equipment, telecommunication equipment, home appliances, amusement equipment, etc.). If the products are to be used in devices requiring extremely high reliability (medical equipment, transport equipment, aircraft/spacecraft, nuclear power controllers, fuel controllers, car equipment including car accessories, safety devices, etc.) and whose malfunction or operational error may endanger human life and sufficient fail-safe measures, please consult with the ROHM sales staff in advance. If product malfunctions may result in serious damage, including that to human life, sufficient fail-safe measures must be taken, including the following:
  - [a] Installation of protection circuits or other protective devices to improve system safety
  - [b] Installation of redundant circuits in the case of single-circuit failure
- 2) The products are designed for use in a standard environment and not in any special environments. Application of the products in a special environment can deteriorate product performance. Accordingly, verification and confirmation of product performance, prior to use, is recommended if used under the following conditions:
  - [a] Use in various types of liquid, including water, oils, chemicals, and organic solvents
  - [b] Use outdoors where the products are exposed to direct sunlight, or in dusty places
  - [c] Use in places where the products are exposed to sea winds or corrosive gases, including Cl<sub>2</sub>, H<sub>2</sub>S, NH<sub>3</sub>, SO<sub>2</sub>, and NO<sub>2</sub>
  - [d] Use in places where the products are exposed to static electricity or electromagnetic waves
  - [e] Use in proximity to heat-producing components, plastic cords, or other flammable items
  - [f] Use involving sealing or coating the products with resin or other coating materials
  - [g] Use involving unclean solder or use of water or water-soluble cleaning agents for cleaning after soldering
  - [h] Use of the products in places subject to dew condensation
- 3) The products are not radiation resistant.
- 4) Verification and confirmation of performance characteristics of products, after on-board mounting, is advised.
- 5) In particular, if a transient load (a large amount of load applied in a short period of time, such as pulse) is applied, confirmation of performance characteristics after on-board mounting is strongly recommended. Avoid applying power exceeding normal rated power; exceeding the power rating under steady-state loading condition may negatively affect product performance and reliability.
- 6) De-rate Power Dissipation (Pd) depending on Ambient temperature (Ta).  
When used in sealed area, confirm the actual ambient temperature.
- 7) Confirm that operation temperature is within the specified range described in product specification.
- 8) Failure induced under deviant condition from what defined in the product specification cannot be guaranteed.

## ●Precaution for Mounting / Circuit board design

- 1) When a highly active halogenous (chlorine, bromine, etc.) flux is used, the remainder of flux may negatively affect product performance and reliability.
- 2) In principle, the reflow soldering method must be used; if flow soldering method is preferred, please consult with the Company in advance.

Regarding Precaution for Mounting / Circuit board design, please specially refer to ROHM Mounting specification

## ●Precautions Regarding Application Examples and External Circuits

- 1) If change is made to the constant of an external circuit, allow a sufficient margin due to variations of the characteristics of the products and external components, including transient characteristics, as well as static characteristics.
- 2) The application examples, their constants, and other types of information contained herein are applicable only when the products are used in accordance with standard methods. Therefore, if mass production is intended, sufficient consideration to external conditions must be made.

● **Precaution for Electrostatic**

This product is Electrostatic sensitive product, which may be damaged due to Electrostatic discharge. Please take proper caution during manufacturing and storing so that voltage exceeding Product maximum rating won't be applied to products. Please take special care under dry condition (e.g. Grounding of human body / equipment / solder iron, isolation from charged objects, setting of Ionizer, friction prevention and temperature / humidity control).

● **Precaution for Storage / Transportation**

- 1) Product performance and soldered connections may deteriorate if the products are stored in the following places:
  - [a] Where the products are exposed to sea winds or corrosive gases, including Cl<sub>2</sub>, H<sub>2</sub>S, NH<sub>3</sub>, SO<sub>2</sub>, and NO<sub>2</sub>
  - [b] Where the temperature or humidity exceeds those recommended by the Company
  - [c] Storage in direct sunshine or condensation
  - [d] Storage in high Electrostatic
- 2) Even under ROHM recommended storage condition, solderability of products out of recommended storage time period may be degraded. It is strongly recommended to confirm solderability before using products of which storage time is exceeding recommended storage time period .
- 3) Store / transport cartons in the correct direction, which is indicated on a carton as a symbol. Otherwise bent leads may occur due to excessive stress applied when dropping of a carton.
- 4) Use products within the specified time after opening a dry bag.

● **Precaution for product label**

QR code printed on ROHM product label is only for internal use, and please do not use at customer site. It might contain a internal part number that is inconsistent with an product part number.

● **Precaution for disposition**

When disposing products please dispose them properly with a industry waste company.

● **Precaution for Foreign exchange and Foreign trade act**

Since concerned goods might be fallen under controlled goods prescribed by Foreign exchange and Foreign trade act, please consult with ROHM in case of export.

● **Prohibitions Regarding Industrial Property**

- 1) Information and data on products, including application examples, contained in these specifications are simply for reference; the Company does not guarantee any industrial property rights, intellectual property rights, or any other rights of a third party regarding this information or data. Accordingly, the Company does not bear any responsibility for:
  - [a] infringement of the intellectual property rights of a third party
  - [b] any problems incurred by the use of the products listed herein.
- 2) The Company prohibits the purchaser of its products to exercise or use the intellectual property rights, industrial property rights, or any other rights that either belong to or are controlled by the Company, other than the right to use, sell, or dispose of the products.