

AOL1446
N-Channel Enhancement Mode Field Effect Transistor
General Description

The AOL1446 uses advanced trench technology to provide excellent $R_{DS(ON)}$, low gate charge and low gate resistance. This device is ideally suited for use as a high side switch in CPU core power conversion.

- RoHS Compliant
- Halogen and Antimony Free Green Device*

Features

V_{DS} (V) = 30V
 I_D = 85A (V_{GS} = 10V)
 $R_{DS(ON)}$ < 7m Ω (V_{GS} = 10V)
 $R_{DS(ON)}$ < 11m Ω (V_{GS} = 4.5V)

UIS Tested
 Rg, Ciss, Coss, Crss Tested

Ultra SO-8™ Top View

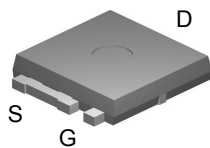

Bottom tab
 connected to
 drain

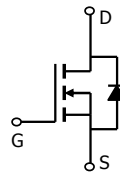
Absolute Maximum Ratings $T_A=25^\circ\text{C}$ unless otherwise noted

| Parameter | Symbol | Maximum | Units |
|---|----------------|-------------------------------------|------------------|
| Drain-Source Voltage | V_{DS} | 30 | V |
| Gate-Source Voltage | V_{GS} | ± 20 | V |
| Continuous Drain Current ^B | I_D | $T_C=25^\circ\text{C}$ ^G | 85 |
| | | $T_C=100^\circ\text{C}$ | 70 |
| Pulsed Drain Current | I_{DM} | 200 | A |
| Continuous Drain Current ^G | I_{DSM} | $T_A=25^\circ\text{C}$ | 14 |
| | | $T_A=70^\circ\text{C}$ | 11 |
| Avalanche Current ^C | I_{AR} | 30 | A |
| Repetitive avalanche energy $L=0.3\text{mH}$ ^C | E_{AR} | 135 | mJ |
| Power Dissipation ^B | P_D | $T_C=25^\circ\text{C}$ | 100 |
| | | $T_C=100^\circ\text{C}$ | 50 |
| Power Dissipation ^A | P_{DSM} | $T_A=25^\circ\text{C}$ | 2.1 |
| | | $T_A=70^\circ\text{C}$ | 1.3 |
| Junction and Storage Temperature Range | T_J, T_{STG} | -55 to 175 | $^\circ\text{C}$ |

Thermal Characteristics

| Parameter | Symbol | Typ | Max | Units |
|--|-----------------|---------------------|------|--------------------|
| Maximum Junction-to-Ambient ^A | $R_{\theta JA}$ | $t \leq 10\text{s}$ | 19.5 | $^\circ\text{C/W}$ |
| Maximum Junction-to-Ambient ^A | | Steady-State | 48 | 60 |
| Maximum Junction-to-Case ^C | $R_{\theta JC}$ | 1 | 1.5 | $^\circ\text{C/W}$ |

Electrical Characteristics (T_J=25°C unless otherwise noted)

| Symbol | Parameter | Conditions | Min | Typ | Max | Units |
|-----------------------------|---------------------------------------|--|-----|----------|----------|-------|
| STATIC PARAMETERS | | | | | | |
| BV _{DSS} | Drain-Source Breakdown Voltage | I _D =250μA, V _{GS} =0V | 30 | | | V |
| I _{DSS} | Zero Gate Voltage Drain Current | V _{DS} =24V, V _{GS} =0V T _J =55°C | | 0.005 | 1 5 | μA |
| I _{GSS} | Gate-Body leakage current | V _{DS} =0V, V _{GS} = ±20V | | | 100 | nA |
| V _{GS(th)} | Gate Threshold Voltage | V _{DS} =V _{GS} I _D =250μA | 1 | 2.3 | 3 | V |
| I _{D(ON)} | On state drain current | V _{GS} =10V, V _{DS} =5V | 100 | | | A |
| R _{DS(ON)} | Static Drain-Source On-Resistance | V _{GS} =10V, I _D =20A T _J =125°C | | 5 6.7 | 7 8.1 | mΩ |
| | | V _{GS} =4.5V, I _D =20A | | 8.4 | 11 | mΩ |
| g _{FS} | Forward Transconductance | V _{DS} =5V, I _D =20A | | 60 | | S |
| V _{SD} | Diode Forward Voltage | I _S =1A, V _{GS} =0V | | 0.72 | 1 | V |
| I _S | Maximum Body-Diode Continuous Current | | | | 85 | A |
| DYNAMIC PARAMETERS | | | | | | |
| C _{iss} | Input Capacitance | V _{GS} =0V, V _{DS} =15V, f=1MHz | | 1325 | 1600 | pF |
| C _{oss} | Output Capacitance | | | 535 | | pF |
| C _{rss} | Reverse Transfer Capacitance | | | 155 | | pF |
| R _g | Gate resistance | V _{GS} =0V, V _{DS} =0V, f=1MHz | | 0.95 | 1.5 | Ω |
| SWITCHING PARAMETERS | | | | | | |
| Q _g (10V) | Total Gate Charge | V _{GS} =4.5V, V _{DS} =15V, I _D =20A | | 26 | 32 | nC |
| Q _g (4.5V) | Total Gate Charge | | | 13.5 | 18 | nC |
| Q _{gs} | Gate Source Charge | | | 3.2 | | nC |
| Q _{gd} | Gate Drain Charge | | | 6.6 | | nC |
| t _{D(on)} | Turn-On DelayTime | V _{GS} =10V, V _{DS} =15V, R _L =0.75Ω, R _{GEN} =3Ω | | 7.2 | 10 | ns |
| t _r | Turn-On Rise Time | | | 12.5 | 18 | ns |
| t _{D(off)} | Turn-Off DelayTime | | | 22 | 33 | ns |
| Q _{rr} | Body Diode Reverse Recovery Charge | I _F =20A, di/dt=100A/μs | | 29 | 36 | nC |

A: The value of R_{θJA} is measured with the device in a still air environment with T_A=25°C.

B: The power dissipation P_D is based on T_{J(MAX)}=175°C, using junction-to-case thermal resistance, and is more useful in setting the upper dissipation limit for cases where additional heatsinking is used.

C: Repetitive rating, pulse width limited by junction temperature T_{J(MAX)}=175°C.

D: The R_{θJA} is the sum of the thermal impedance from junction to case R_{θJC} and case to ambient.

E: The static characteristics in Figures 1 to 6 are obtained using <300 μs pulses, duty cycle 0.5% max.

F: These curves are based on the junction-to-case thermal impedance which is measured with the device mounted to a large heatsink, assuming a maximum junction temperature of T_{J(MAX)}=175°C.

G: Surface mounted on a 1 in 2 FR-4 board with 2oz. Copper.

H: These tests are performed with the device mounted on 1 in 2 FR-4 board with 2oz. Copper, in a still air environment with T_A=25°C. The SOA curve provides a single pulse rating.

* This device is guaranteed green after date code 8P11 (June 1ST 2008)

Revision 2: June 2008

THIS PRODUCT HAS BEEN DESIGNED AND QUALIFIED FOR THE CONSUMER MARKET. APPLICATIONS OR USES AS CRITICAL COMPONENTS IN LIFE SUPPORT DEVICES OR SYSTEMS ARE NOT AUTHORIZED. AOS DOES NOT ASSUME ANY LIABILITY ARISING OUT OF SUCH APPLICATIONS OR USES OF ITS PRODUCTS. AOS RESERVES THE RIGHT TO IMPROVE PRODUCT DESIGN, FUNCTIONS AND RELIABILITY WITHOUT NOTICE.

TYPICAL ELECTRICAL AND THERMAL CHARACTERISTICS

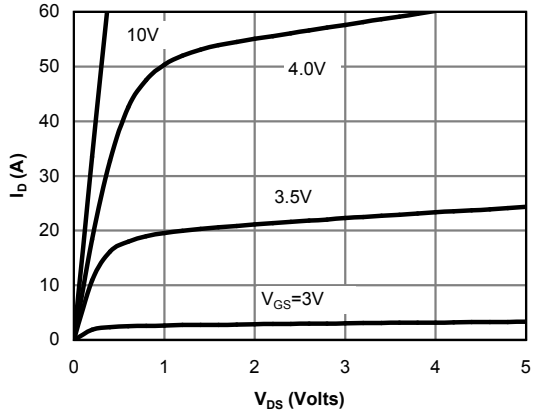

Fig 1: On-Region Characteristics

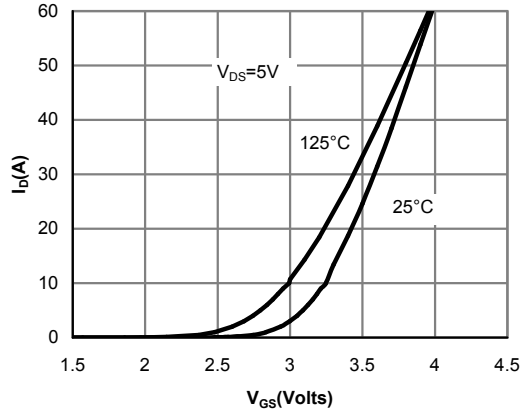

Figure 2: Transfer Characteristics

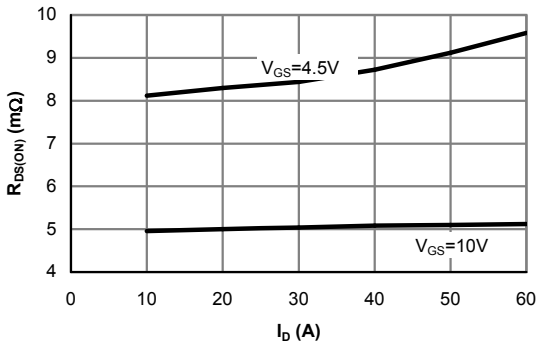

Figure 3: On-Resistance vs. Drain Current and Gate Voltage

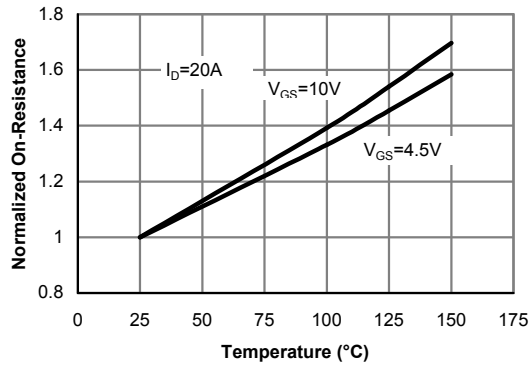

Figure 4: On-Resistance vs. Junction Temperature

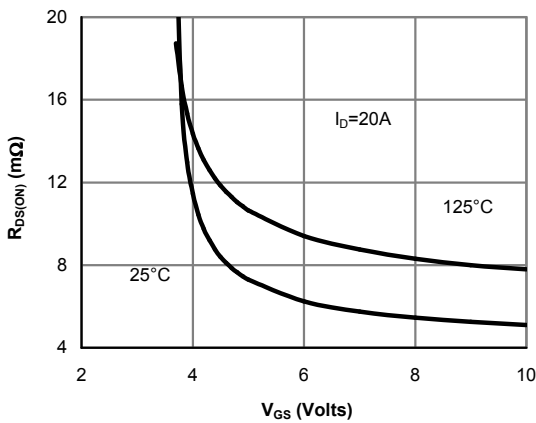

Figure 5: On-Resistance vs. Gate-Source Voltage

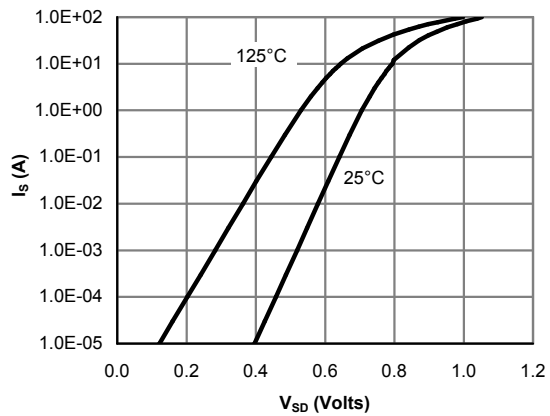

Figure 6: Body-Diode Characteristics

TYPICAL ELECTRICAL AND THERMAL CHARACTERISTICS

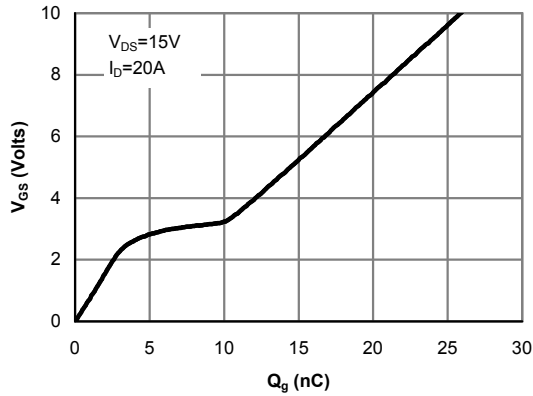

Figure 7: Gate-Charge Characteristics

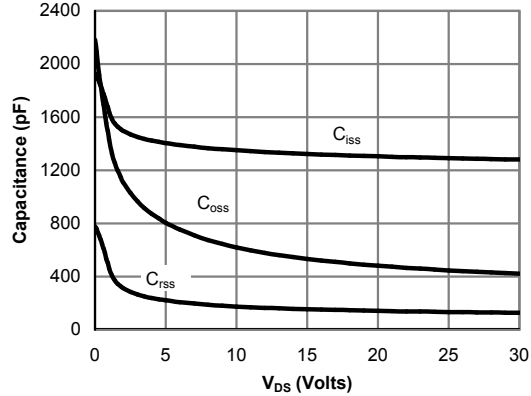

Figure 8: Capacitance Characteristics

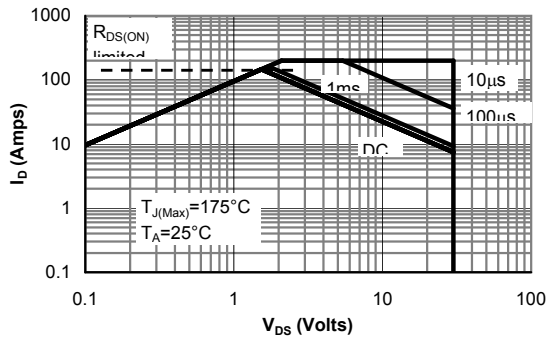

Figure 9: Maximum Forward Biased Safe Operating Area (Note H)

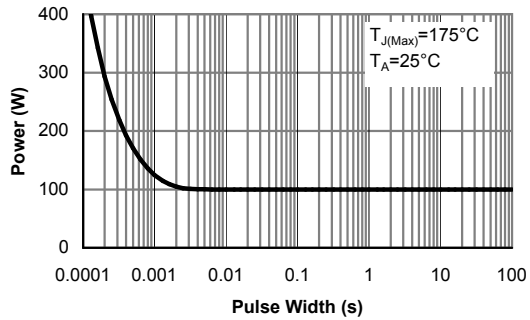

Figure 10: Single Pulse Power Rating Junction-to-Case (Note F)

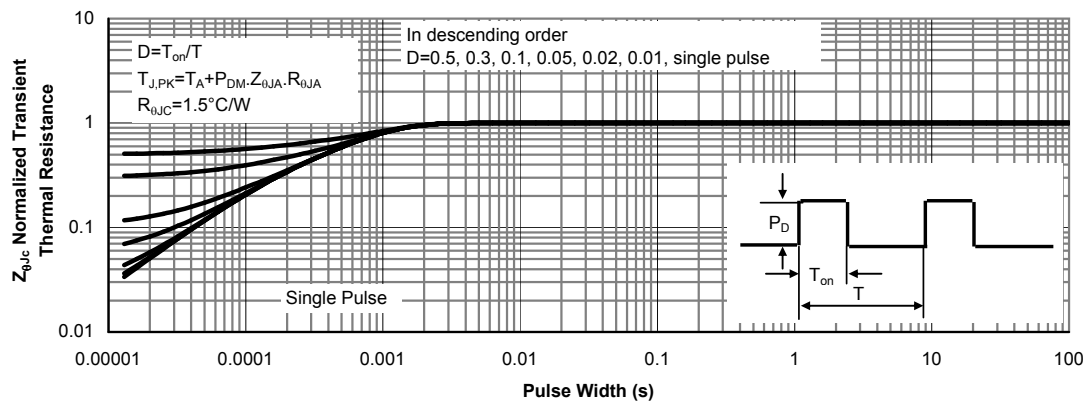

Figure 11: Normalized Maximum Transient Thermal Impedance (Note F)

TYPICAL ELECTRICAL AND THERMAL CHARACTERISTICS

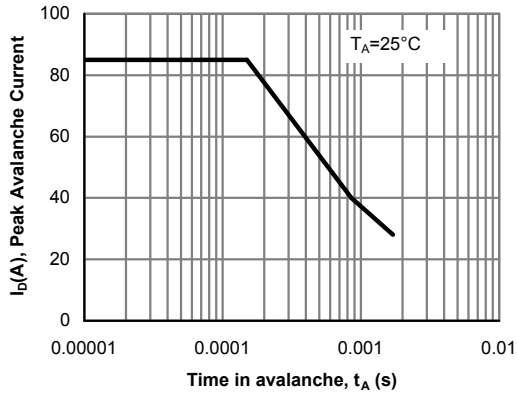

Figure 12: Single Pulse Avalanche capability

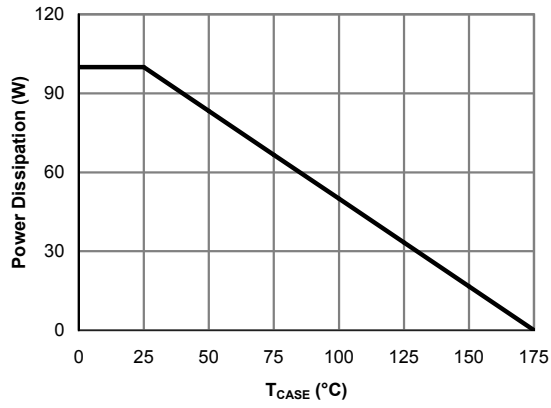

Figure 13: Power De-rating (Note B)

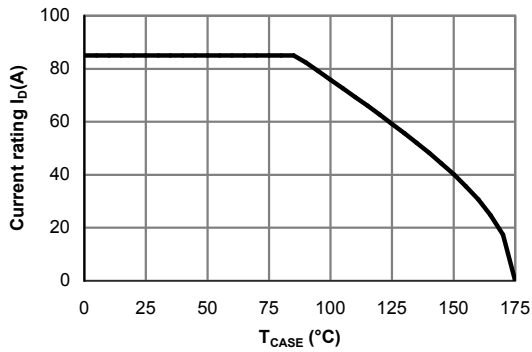

Figure 14: Current De-rating (Note B)

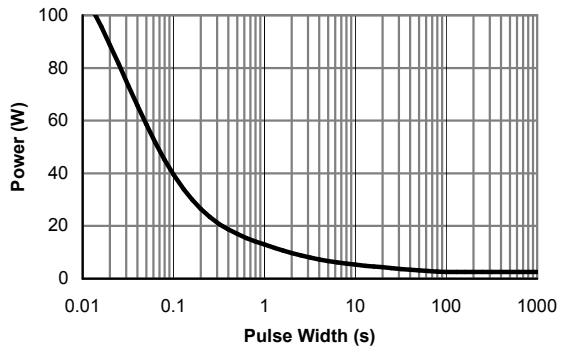

Figure 15: Single Pulse Power Rating Junction-to-Ambient (Note H)

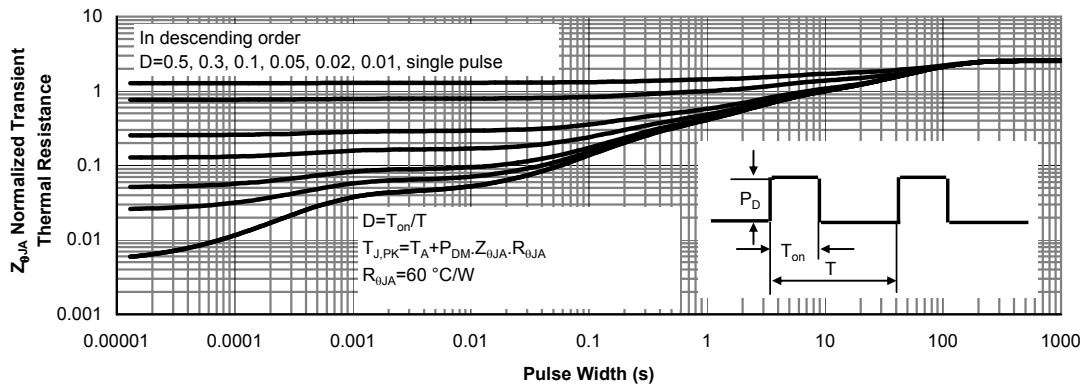
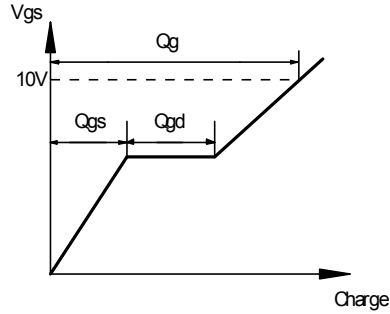
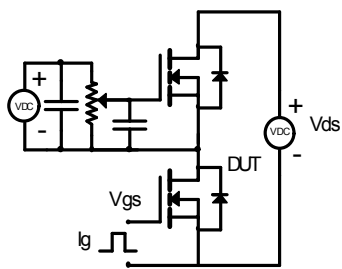
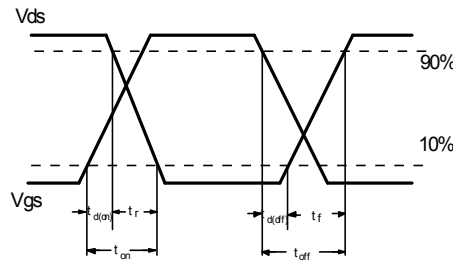
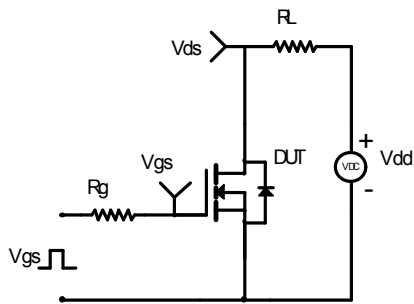

Figure 16: Normalized Maximum Transient Thermal Impedance (Note H)

Gate Charge Test Circuit & Waveform



Resistive Switching Test Circuit & Waveforms



Unclamped Inductive Switching (UIS) Test Circuit & Waveforms

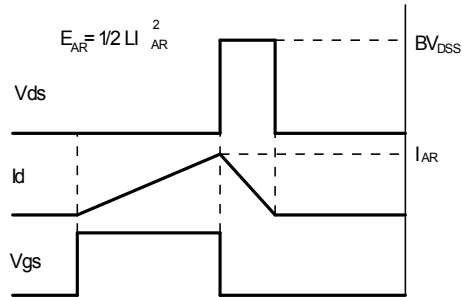
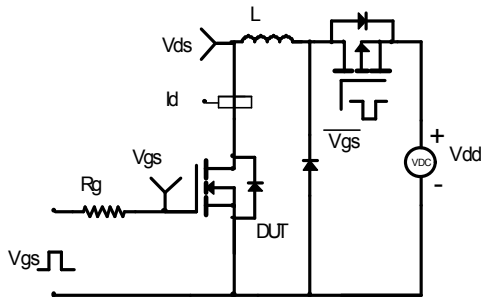

Diode Recovery Test Circuit & Waveforms

