



# HERA801G THRU HERA808G

## 8.0 AMPS. Glass Passivated High Efficient Rectifiers



Voltage Range  
50 to 1000 Volts  
Current  
8.0 Amperes

### Features

- ✧ Low forward voltage drop
- ✧ High current capability
- ✧ High reliability
- ✧ High surge current capability

### Mechanical Data

- ✧ Cases: Molded plastic
- ✧ Epoxy: UL 94V-O rate flame retardant
- ✧ Terminals: Leads solderable per MIL-STD-202, Method 208

guaranteed

- ✧ Polarity: As marked
- ✧ High temperature soldering guaranteed: 260°C/10 seconds .16", (4.06mm) from case.
- ✧ Weight: 2.24 grams

### TO-220A

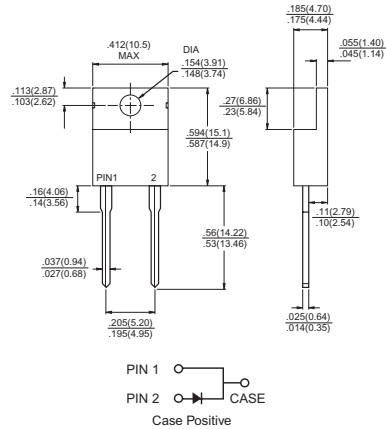

Dimensions in inches and (millimeters)

### Maximum Rating and Electrical Characteristics

Rating at 25°C ambient temperature unless otherwise specified.

Single phase, half wave 60 Hz, resistive or inductive load.

For capacitive load, derate current by 20%

Type Number	Symbol	HERA 801G	HERA 802G	HERA 803G	HERA 804G	HERA 805G	HERA 806G	HERA 807G	HERA 808G	Units
Maximum Recurrent Peak Reverse Voltage	$V_{RRM}$	50	100	200	300	400	600	800	1000	V
Maximum RMS Voltage	$V_{RMS}$	35	70	140	210	280	420	560	700	V
Maximum DC Blocking Voltage	$V_{DC}$	50	100	200	300	400	600	800	1000	V
Maximum Average Forward Rectified Current .375"(9.5mm) Lead Length @ $T_C=100^\circ C$	$I_{(AV)}$	8.0								A
Peak Forward Surge Current, 8.3 ms Single Half Sine-wave Superimposed on Rated Load (JEDEC method)	$I_{FSM}$	150								A
Maximum Instantaneous Forward Voltage @ 8.0A	$V_F$	1.0			1.3		1.7			V
Maximum DC Reverse Current @ $T_A=25^\circ C$ at Rated DC Blocking Voltage @ $T_A=125^\circ C$	$I_R$	10.0 400								 uA
Maximum Reverse Recovery Time (Note 1)	$T_{rr}$	50				80				nS
Typical Junction Capacitance (Note 2)	$C_j$	65				55				pF
Typical Thermal Resistance (Note 3)	$R_{\theta JC}$	2.0								$^\circ C/W$
Operating Temperature Range	$T_J$	-65 to +150								$^\circ C$
Storage Temperature Range	$T_{STG}$	-65 to +150								$^\circ C$

Notes: 1. Reverse Recovery Test Conditions:  $I_F=0.5A$ ,  $I_R=1.0A$ ,  $I_{RR}=0.25A$   
 2. Measured at 1 MHz and Applied Reverse Voltage of 4.0V D.C.  
 3. Mounted on Heatsink Size of 2 in x 3 in x 0.25 in Al-Plate.

## RATINGS AND CHARACTERISTIC CURVES (HERA801G THRU HERA808G)

FIG. 1- REVERSE RECOVERY TIME CHARACTERISTIC AND TEST CIRCUIT DIAGRAM

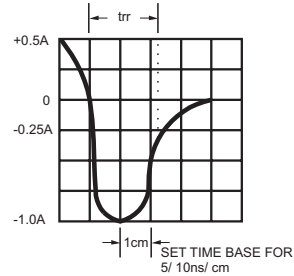
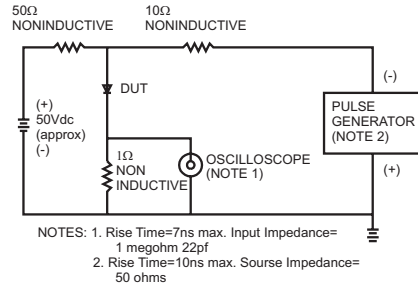

FIG. 2- MAXIMUM FORWARD CURRENT DERATING CURVE

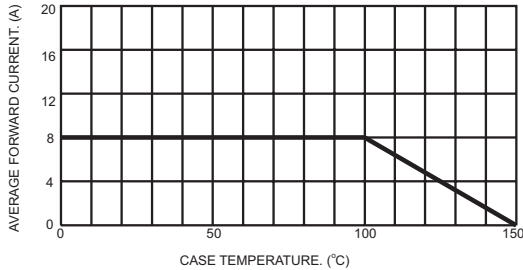

FIG. 3- TYPICAL REVERSE CHARACTERISTICS

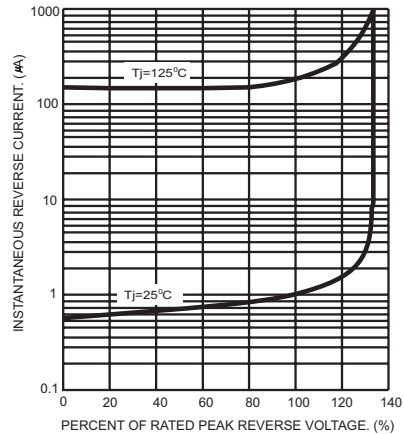

FIG. 4- MAXIMUM NON-REPETITIVE FORWARD SURGE CURRENT

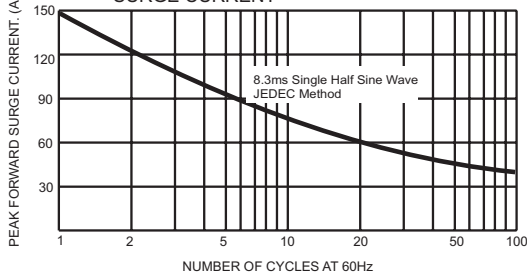

FIG. 6- TYPICAL FORWARD CHARACTERISTICS

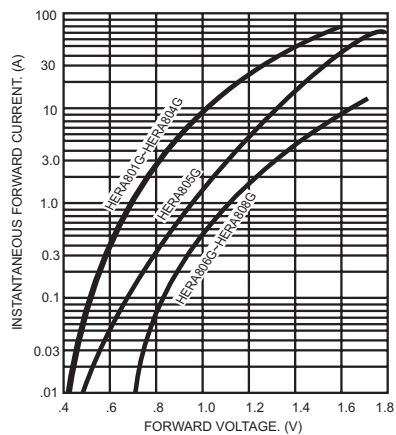

FIG. 5- TYPICAL JUNCTION CAPACITANCE

