



SANYO Semiconductors

DATA SHEET

An ON Semiconductor Company

5LN01SP — N-Channel Silicon MOSFET — Ultrahigh-Speed Switching Applications

Features

- Low ON-resistance
- Ultrahigh-speed switching
- 2.5V drive

Specifications

Absolute Maximum Ratings at Ta=25°C

Parameter	Symbol	Conditions	Ratings	Unit
Drain-to-Source Voltage	V _{DSS}		50	V
Gate-to-Source Voltage	V _{GSS}		±10	V
Drain Current (DC)	I _D		0.1	A
Drain Current (Pulse)	I _{DP}	PW≤10μs, duty cycle≤1%	0.4	A
Allowable Power Dissipation	P _D		0.25	W
Channel Temperature	T _{ch}		150	°C
Storage Temperature	T _{stg}		-55 to +150	°C

This product is designed to "ESD immunity < 200V**", so please take care when handling.

* Machine Model

Package Dimensions

unit : mm (typ)

7524-007

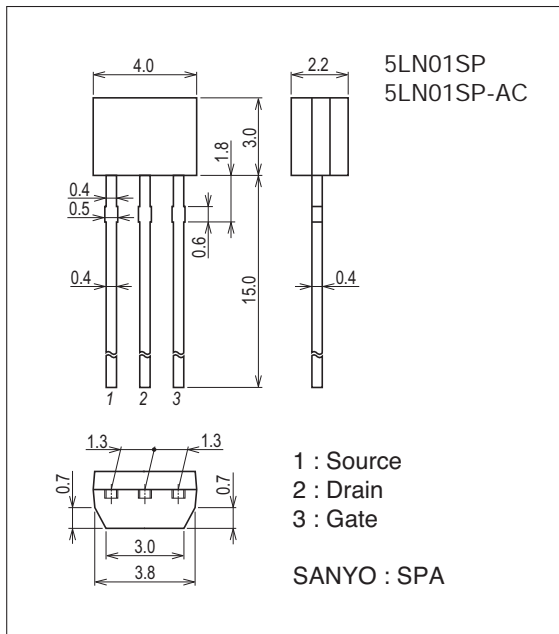

Product & Package Information

- Package : SPA
- JEITA, JEDEC : SC-72
- Minimum Packing Quantity : 2,500 pcs./box, 500 pcs./bag

Marking

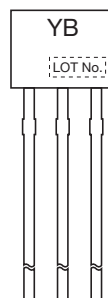

Electrical Connection

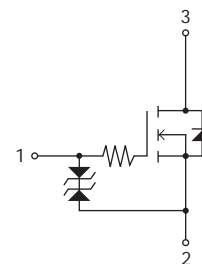

5LN01SP

Electrical Characteristics at Ta=25°C

Parameter	Symbol	Conditions	Ratings			Unit
			min	typ	max	
Drain-to-Source Breakdown Voltage	V(BR)DSS	I _D =1mA, V _{GS} =0V	50			V
Zero-Gate Voltage Drain Current	I _{DSS}	V _{DS} =50V, V _{GS} =0V			10	μA
Gate-to-Source Leakage Current	I _{GSS}	V _{GS} =±8V, V _{DS} =0V			±10	μA
Cutoff Voltage	V _{GS(off)}	V _{DS} =10V, I _D =100μA	0.4		1.3	V
Forward Transfer Admittance	y _{fs}	V _{DS} =10V, I _D =50mA	0.13	0.18		S
Static Drain-to-Source On-State Resistance	R _{DS(on)1}	I _D =50mA, V _{GS} =4V		6	7.8	Ω
	R _{DS(on)2}	I _D =30mA, V _{GS} =2.5V		7.1	9.9	Ω
	R _{DS(on)3}	I _D =10mA, V _{GS} =1.5V		10	20	Ω
Input Capacitance	C _{iss}	V _{DS} =10V, f=1MHz		6.6		pF
Output Capacitance	C _{oss}			4.7		pF
Reverse Transfer Capacitance	C _{rss}			1.7		pF
Turn-ON Delay Time	t _{d(on)}		See specified Test Circuit.		18	
Rise Time	t _r			42		ns
Turn-OFF Delay Time	t _{d(off)}			190		ns
Fall Time	t _f			105		ns
Total Gate Charge	Q _g	V _{DS} =10V, V _{GS} =10V, I _D =100mA			1.57	
Gate-to-Source Charge	Q _{gs}			0.20		nC
Gate-to-Drain "Miller" Charge	Q _{gd}			0.32		nC
Diode Forward Voltage	V _{SD}	I _S =100mA, V _{GS} =0V		0.85	1.2	V

Switching Time Test Circuit

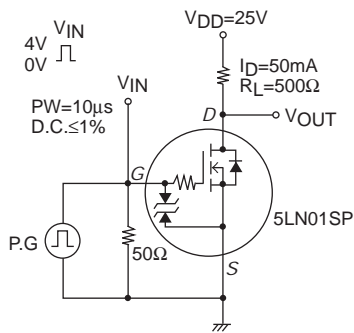

Ordering Information

Device	Package	Shipping	memo
5LN01SP	SPA	500pcs./bag	Pb Free
5LN01SP-AC	SPA	2,500pcs./box	

5LN01SP

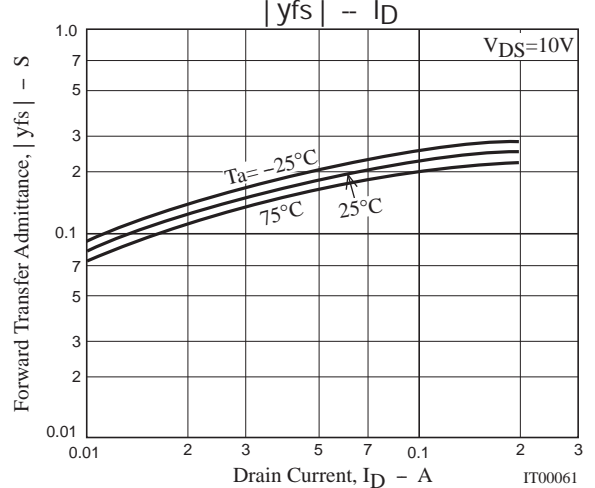
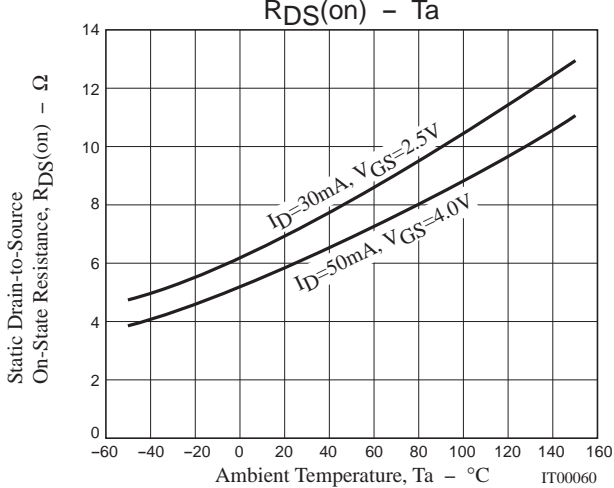
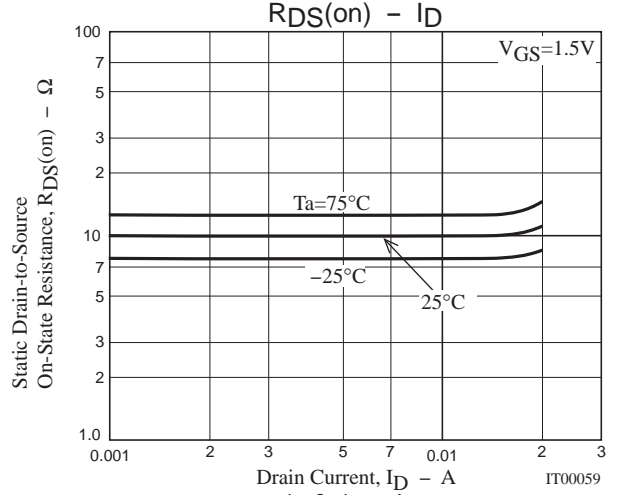
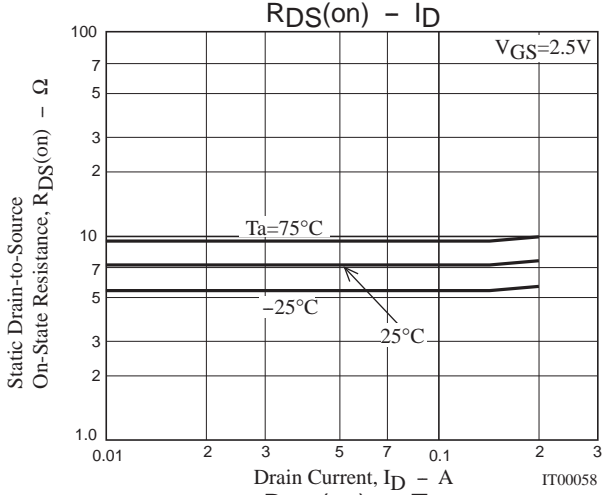
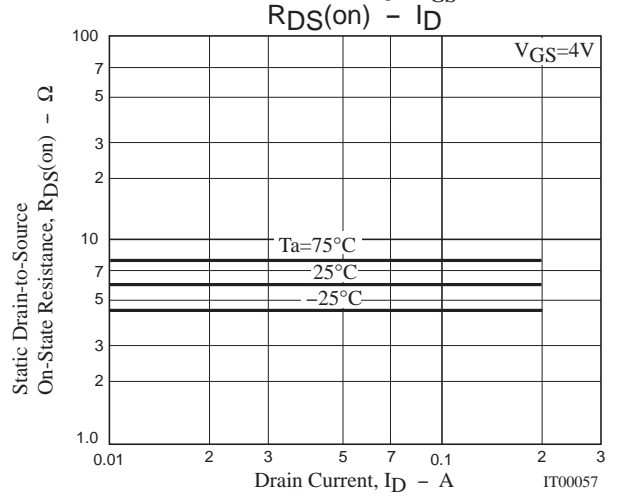
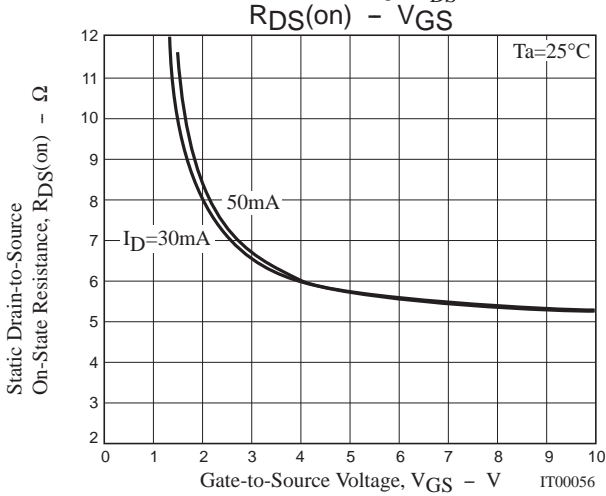
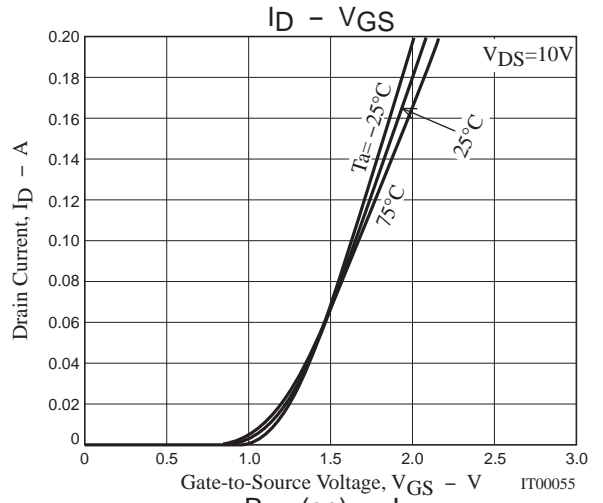
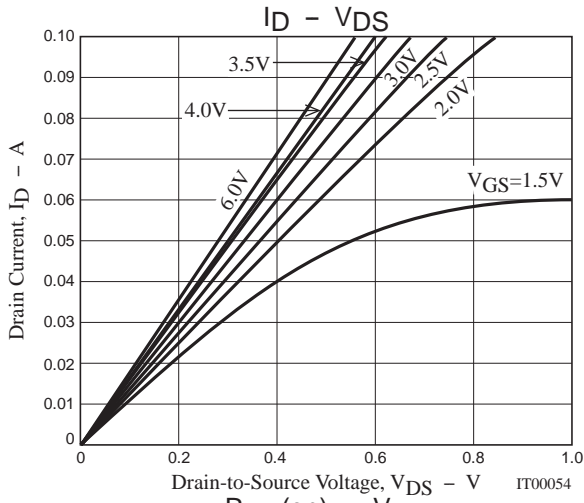

5LN01SP

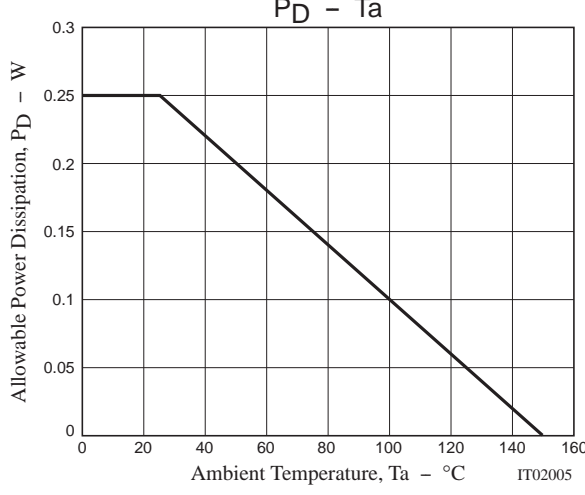
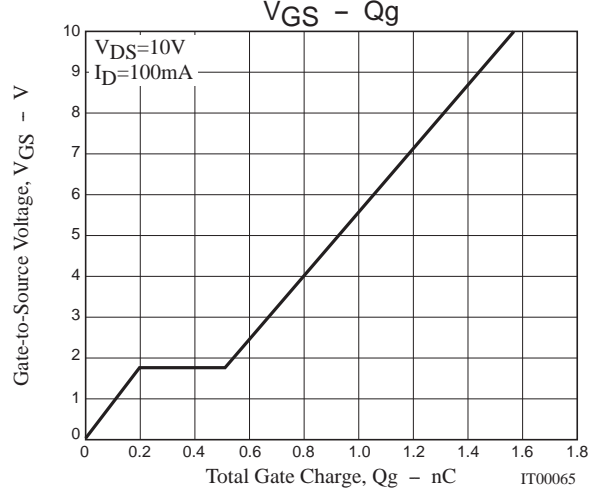
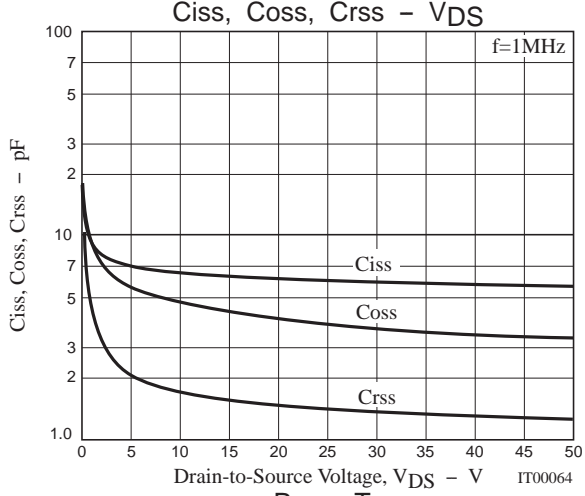
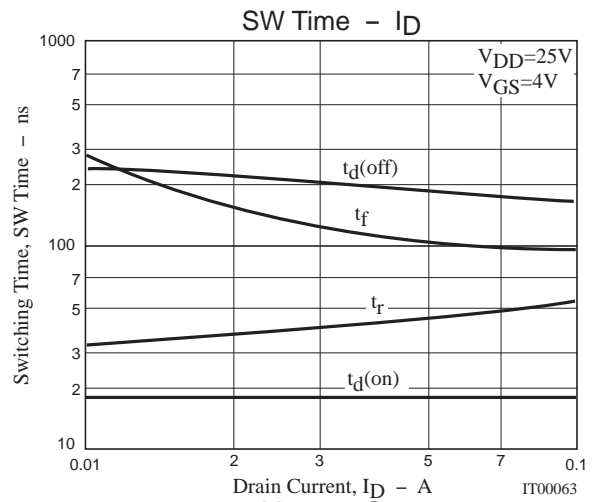
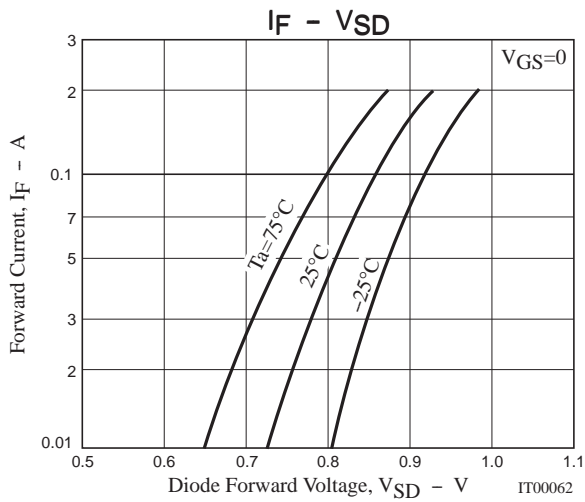

Taping Specification

5LN01SP-AC

Storage package Outline name	Package type	Maximum Number of devices contained(pcs.)		Packing format	
		Inner box No.	Storage quantity	Outer box (C-6)	Outer box (C-8)
SPA	A C	C-2 Inner box Dimensions :mm(external) 330×45×145	2,500	16 inner boxes contained(40,000pcs.) Outer box Dimensions:mm(external) 585×345×200	8 inner boxes contained(20,000pcs.) Outer box Dimensions:mm(external) 345×300×200
	A L	C-2 Inner box Dimensions :mm(external) 330×45×145	2,400	16 inner boxes contained(38,400pcs.) Outer box Dimensions:mm(external) 585×345×200	8 inner boxes contained(19,200pcs.) Outer box Dimensions:mm(internal) 345×300×200
	A P	C-4 Inner box Dimensions :mm(external) 330×45×285	5,000	8 inner boxes contained(40,000pcs.) Outer box Dimensions:mm(external) 585×345×200	4 inner boxes contained(20,000pcs.) Outer box Dimensions:mm(internal) 345×300×200
	A S	C-2 Inner box Dimensions :mm(external) 330×45×145	1,200	16 inner boxes contained(9,200pcs.) Outer box Dimensions:mm(external) 585×345×200	8 inner boxes contained(9,600 pcs.) Outer box Dimensions:mm(internal) 345×300×200

1. Packing format

Packing method

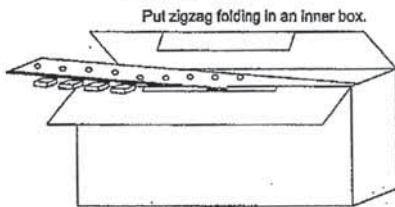

Sample bar code label

(Unit : mm)

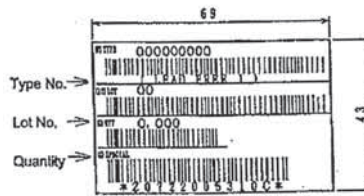

*LEAD FREE 1 :
Lead-free external terminal surface treatment product.

2. Taping specifications

2-1. Carrier tape size (Unit:mm)

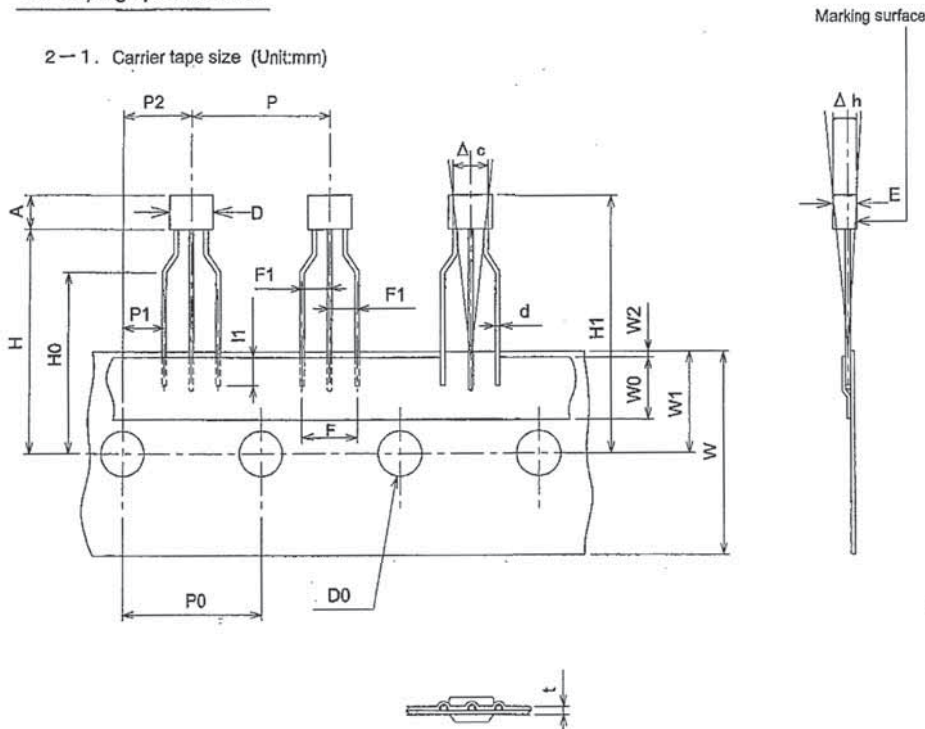

5LN01SP

2-2. Taping size standard

Unit:mm

Item	Symbol	Standard	Tolerance
Work piece outside diameter	D	4.0	±0.2
	E	2.2	±0.2
Work piece height	A	3.0	±0.2
Lead wire diameter	d	0.4 × 0.4 t	±0.1
Bonded lead wire	l1	2.5MIN	
Pitch between products	P	12.7	±1.0
Pitch between perforations	P0	12.7	±0.2
Total pitch for 21 perforations	P0 × 20	254.0	±1.0
Distance between lead wire	F	5.0	+0.8 -0.2
Lead wire pitch distance	F1	2.5	+0.4 -0.1
Product inclination	Δ h	0	±2.0
Displacement of perforations	P1	3.85	±0.3
	P2	6.35	±0.3
Displacement of tape	W2	0.5MAX	Not to be displaced to the outside of the board

Item	Symbol	Standard	Tolerance
Tape width	W	18.0	+1.0 -0.5
Adhesive tape	W0	6.0	±1.0
Displacement of perforations	W1	9.0	+0.75 -0.5
Work piece bottom surface position	H	19.8	+1.0 -0.3
Lead wire clinch height	H0	16.0	±0.5
Work piece upper limit position	H1	22.8	±1.5
Perforations diameter	D0	φ 4.0	±0.2
Tape thickness (total thickness)	t	0.6	±0.2
Product inclination	Δ c	0	±1.0

2-3. Taping structure

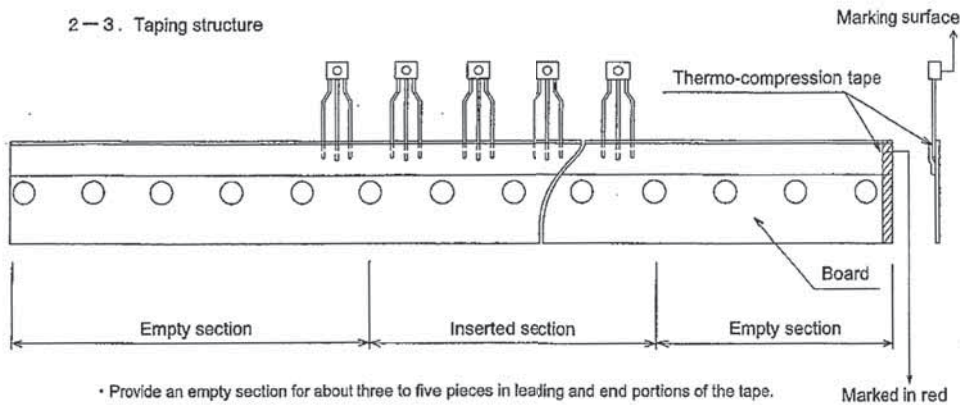

- Provide an empty section for about three to five pieces in leading and end portions of the tape.
- Provide marking in red to the E-side end of the board.

5LN01SP

Outline Drawing

5LN01SP-AC

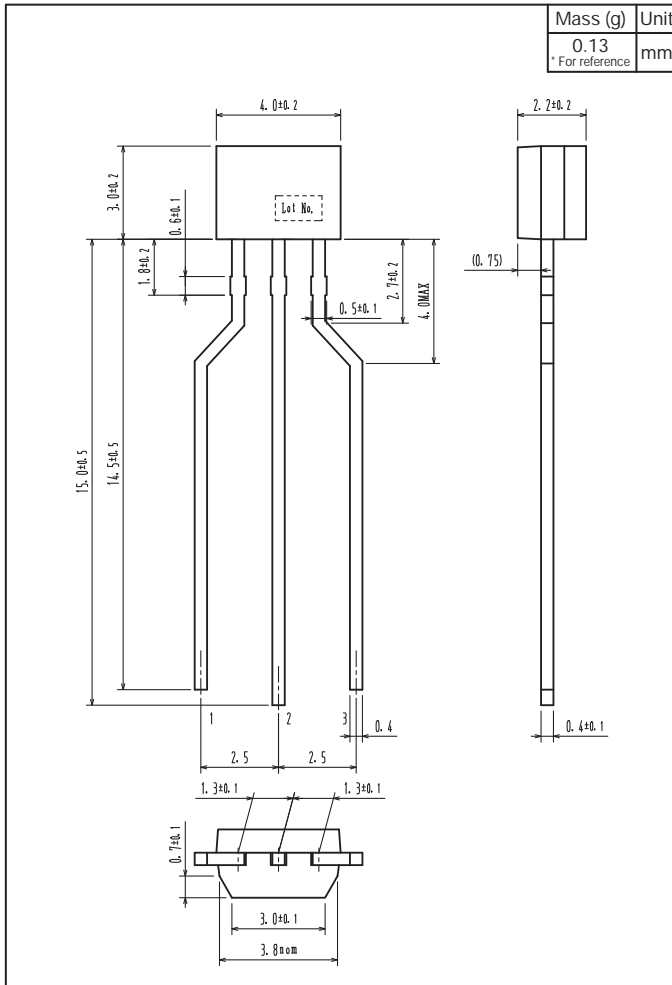

5LN01SP

Bag Packing Specification

5LN01SP

1. Packing Format

Package Name	Maximum Number of devices contained (pcs)				
	Bag	Inner BOX		Outer BOX	
SPA	500	B-1	B-1/2	A-1	A-2
		20,000	10,000	100,000	60,000
Packing format (Dimensions:mm (external))					
		Inner BOX		Outer BOX	
		B-1	B-1/2	A-1	A-2
		445×225×55	445×225×55	470×250×300	470×250×190

2. Bag dimensions

(unit:mm)

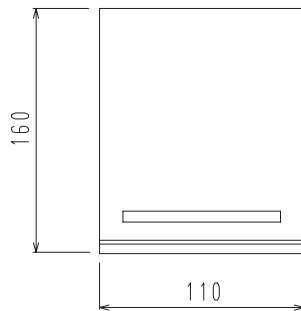

3. Bag label, Inner box label

(unit:mm)

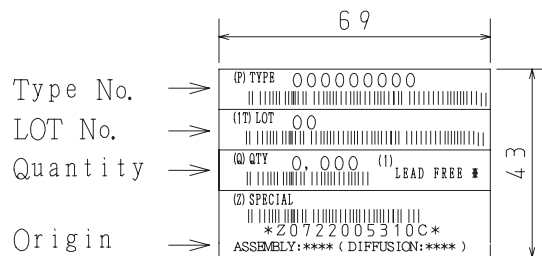

4. Outer box label

(unit:mm)

It is a label at the time of factory shipments. The form of a label may change in physical distribution process.

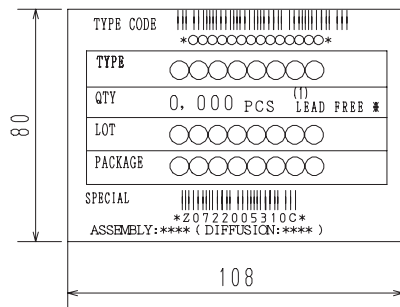

NOTE (1)

The LEAD FREE * description shows that the surface treatment of the terminal is lead free.

Label	JEITA Phase
LEAD FREE 3	JEITA Phase 3A
LEAD FREE 4	JEITA Phase 3

5LN01SP

Outline Drawing

5LN01SP

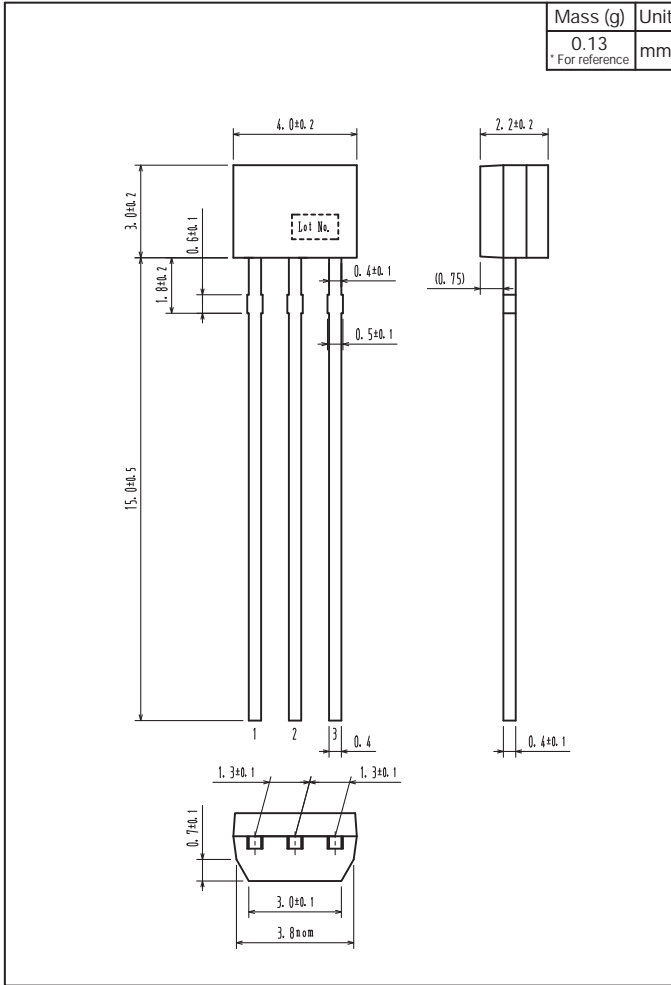

Note on usage : Since the 5LN01SP is a MOSFET product, please avoid using this device in the vicinity of highly charged objects.

- Any and all SANYO Semiconductor Co.,Ltd. products described or contained herein are, with regard to "standard application", intended for the use as general electronics equipment. The products mentioned herein shall not be intended for use for any "special application" (medical equipment whose purpose is to sustain life, aerospace instrument, nuclear control device, burning appliances, transportation machine, traffic signal system, safety equipment etc.) that shall require extremely high level of reliability and can directly threaten human lives in case of failure or malfunction of the product or may cause harm to human bodies, nor shall they grant any guarantee thereof. If you should intend to use our products for new introduction or other application different from current conditions on the usage of automotive device, communication device, office equipment, industrial equipment etc. , please consult with us about usage condition (temperature, operation time etc.) prior to the intended use. If there is no consultation or inquiry before the intended use, our customer shall be solely responsible for the use.
- Specifications of any and all SANYO Semiconductor Co.,Ltd. products described or contained herein stipulate the performance, characteristics, and functions of the described products in the independent state, and are not guarantees of the performance, characteristics, and functions of the described products as mounted in the customer's products or equipment. To verify symptoms and states that cannot be evaluated in an independent device, the customer should always evaluate and test devices mounted in the customer's products or equipment.
- SANYO Semiconductor Co.,Ltd. assumes no responsibility for equipment failures that result from using products at values that exceed, even momentarily, rated values (such as maximum ratings, operating condition ranges, or other parameters) listed in products specifications of any and all SANYO Semiconductor Co.,Ltd. products described or contained herein.
- Regarding monolithic semiconductors, if you should intend to use this IC continuously under high temperature, high current, high voltage, or drastic temperature change, even if it is used within the range of absolute maximum ratings or operating conditions, there is a possibility of decrease reliability. Please contact us for a confirmation.
- SANYO Semiconductor Co.,Ltd. strives to supply high-quality high-reliability products, however, any and all semiconductor products fail or malfunction with some probability. It is possible that these probabilistic failures or malfunction could give rise to accidents or events that could endanger human lives, trouble that could give rise to smoke or fire, or accidents that could cause damage to other property. When designing equipment, adopt safety measures so that these kinds of accidents or events cannot occur. Such measures include but are not limited to protective circuits and error prevention circuits for safe design, redundant design, and structural design.
- In the event that any or all SANYO Semiconductor Co.,Ltd. products described or contained herein are controlled under any of applicable local export control laws and regulations, such products may require the export license from the authorities concerned in accordance with the above law.
- No part of this publication may be reproduced or transmitted in any form or by any means, electronic or mechanical, including photocopying and recording, or any information storage or retrieval system, or otherwise, without the prior written consent of SANYO Semiconductor Co.,Ltd.
- Any and all information described or contained herein are subject to change without notice due to product/technology improvement, etc. When designing equipment, refer to the "Delivery Specification" for the SANYO Semiconductor Co.,Ltd. product that you intend to use.
- Upon using the technical information or products described herein, neither warranty nor license shall be granted with regard to intellectual property rights or any other rights of SANYO Semiconductor Co.,Ltd. or any third party. SANYO Semiconductor Co.,Ltd. shall not be liable for any claim or suits with regard to a third party's intellectual property rights which has resulted from the use of the technical information and products mentioned above.

This catalog provides information as of November, 2012. Specifications and information herein are subject to change without notice.