

**SURFACE MOUNT FAST RECOVERY RECTIFIER**

**VOLTAGE RANGE 50 to 600 Volts CURRENT 0.5 Ampere**

**FEATURES**

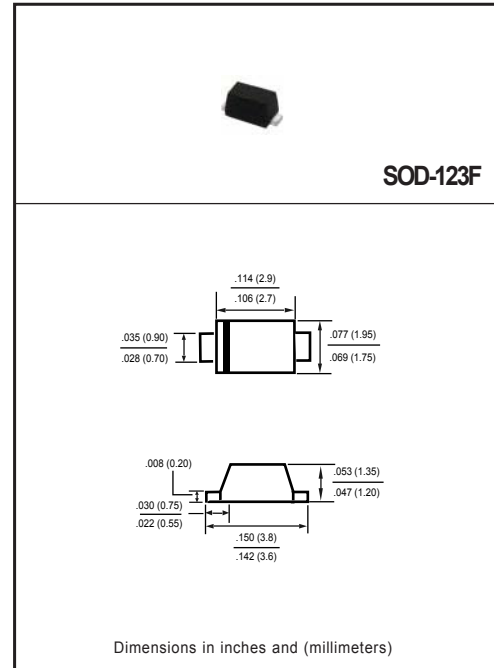
- \* Fast switching
- \* Low leakage
- \* Low forward voltage drop
- \* High current capability
- \* High current surge
- \* High reliability

**MECHANICAL DATA**

- \* Epoxy: Device has UL flammability classification 94V-O
- \* Mounting position: Any
- \* Weight: 0.016 gram

**MAXIMUM RATINGS AND ELECTRICAL CHARACTERISTICS**

Ratings at 25 °C ambient temperature unless otherwise specified.  
Single phase, half wave, 60 Hz, resistive or inductive load.  
For capacitive load, derate current by 20%.



**MAXIMUM RATINGS (@ TA=25 °C unless otherwise noted)**

| RATINGS   | SYMBOL                            | 05F1         | 05F2 | 05F3 | 05F4 | 05F5 | UNITS |
|---|-----------------------------------|--------------|------|------|------|------|-------|
| Maximum Recurrent Peak Reverse Voltage  | V <sub>RRM</sub>                  | 50           | 100  | 200  | 400  | 600  | Volts |
| Maximum RMS Voltage   | V <sub>RMS</sub>                  | 35           | 70   | 140  | 280  | 420  | Volts |
| Maximum DC Blocking Voltage   | V <sub>DC</sub>                   | 50           | 100  | 200  | 400  | 600  | Volts |
| Maximum Average Forward Rectified Current at T <sub>A</sub> = 55°C                                | I <sub>O</sub>                    | 0.5          |      |      |      |      | Amps  |
| Peak Forward Surge Current 8.3 ms single half sine-wave superimposed on rated load (JEDEC method) | I <sub>FSM</sub>                  | 15           |      |      |      |      | Amps  |
| Typical Thermal Resistance (Note 4)   | R <sub>θJA</sub>                  | 32           |      |      |      |      | °C/W  |
|   | R <sub>θJL</sub>                  | 150          |      |      |      |      |       |
| Typical Junction Capacitance (Note 2)   | C <sub>J</sub>                    | 15           |      |      |      |      | pF    |
| Operating and Storage Temperature Range   | T <sub>J</sub> , T <sub>STG</sub> | -55 to + 150 |      |      |      |      | °C    |

**ELECTRICAL CHARACTERISTICS (@TA=25 °C unless otherwise noted)**

| CHARACTERISTICS  | SYMBOL          | 05F1 | 05F2 | 05F3 | 05F4 | 05F5 | UNITS |
|--|-----------------|------|------|------|------|------|-------|
| Maximum Instantaneous Forward Voltage at 1.0ADC  | V <sub>F</sub>  | 1.3  |      |      |      |      | Volts |
| Maximum DC Reverse Current at Rated DC Blocking Voltage T <sub>A</sub> = 25°C                            | I <sub>R</sub>  | 5.0  |      |      |      |      | uAmps |
| Maximum Full Load Reverse Current Full Cycle Average, .375" (9.5mm) lead length at T <sub>L</sub> = 55°C |                 | 100  |      |      |      |      |       |
| Maximum Reverse Recovery Time (Note 1)   | t <sub>rr</sub> | 150  |      |      |      | 250  | nSec  |

- NOTES : 1. Reverse Recovery Test Conditions: I<sub>F</sub> = 0.5A, I<sub>R</sub> = -1.0A, I<sub>RR</sub> = -0.25A  
 2. Measured at 1 MHz and applied reverse voltage of 4.0 volts  
 3. "Fully ROHS compliant", "100% Sn plating (Pb-free)".  
 4. Thermal Resistance : Mounted on PCB.

## RATING AND CHARACTERISTICS CURVES ( 05F1 THRU 05F5 )

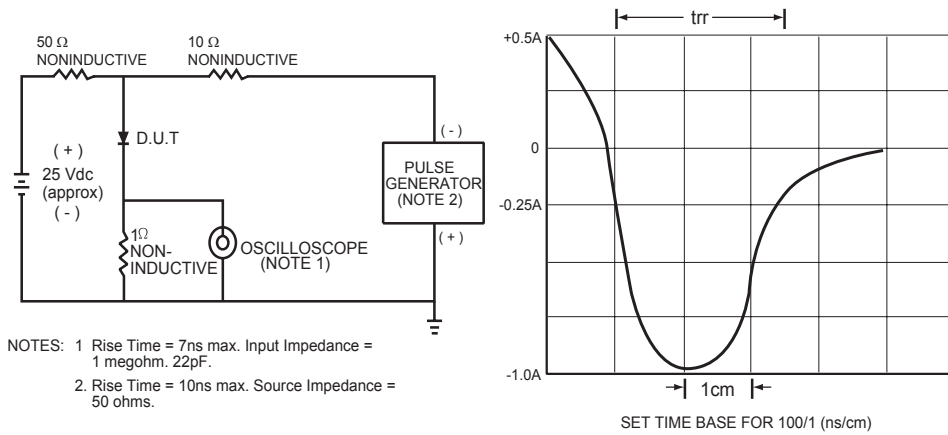


FIG.1 TEST CIRCUIT DIAGRAM AND REVERSE RECOVERY TIME CHARACTERISTIC

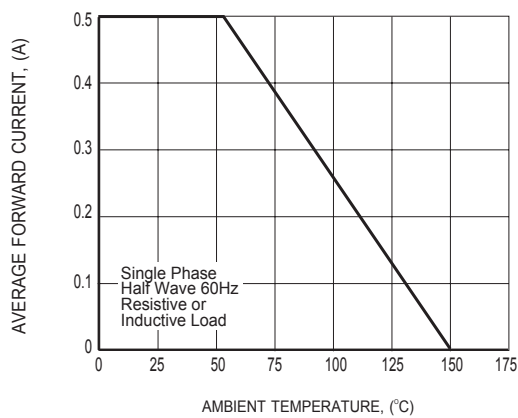


FIG.2 TYPICAL FORWARD CURRENT DERATING CURVE

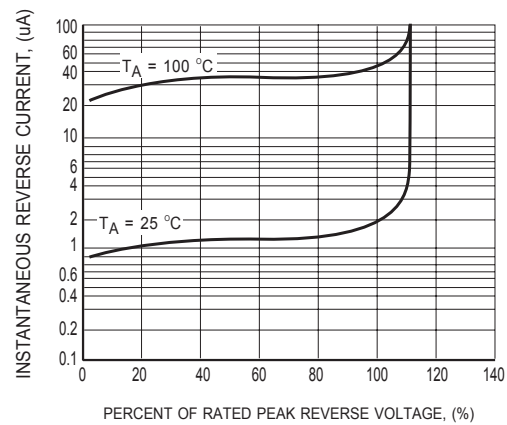
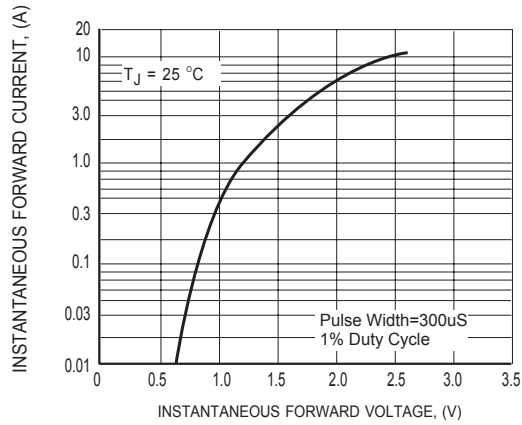
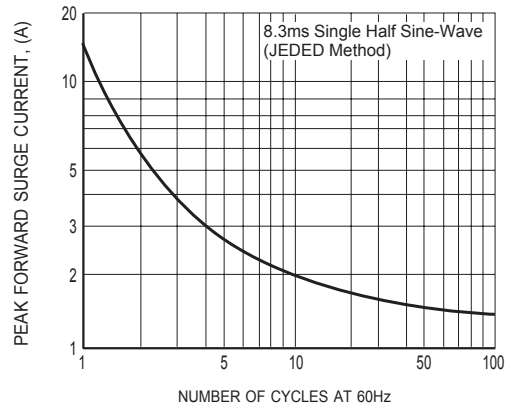


FIG.3 TYPICAL REVERSE CHARACTERISTICS

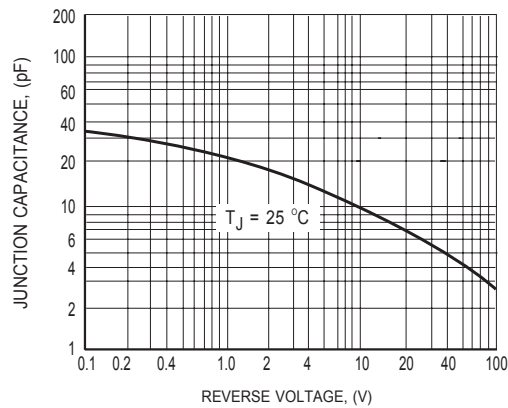
## RATING AND CHARACTERISTICS CURVES ( 05F1 THRU 05F5 )



**FIG.4 TYPICAL INSTANTANEOUS FORWARD CHARACTERISTICS**

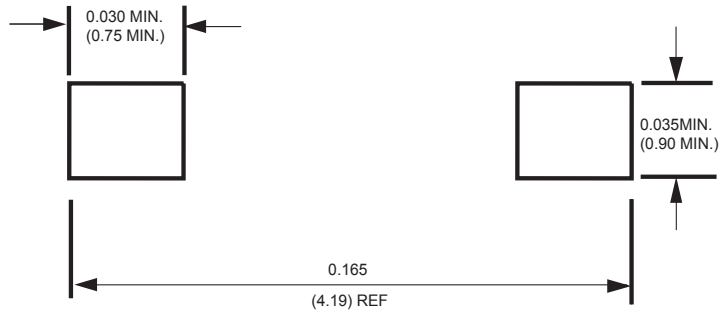


**FIG.5 MAXIMUM NON-REPETITIVE FORWARD SURGE CURRENT**



**FIG.6 TYPICAL JUNCTION CAPACITANCE**

## Mounting Pad Layout



Dimensions in inches and (millimeters)

## DISCLAIMER NOTICE

Rectron Inc reserves the right to make changes without notice to any product specification herein, to make corrections, modifications, enhancements or other changes. Rectron Inc or anyone on its behalf assumes no responsibility or liability for any errors or inaccuracies. Data sheet specifications and its information contained are intended to provide a product description only. "Typical" parameters which may be included on RECTRON data sheets and/ or specifications can and do vary in different applications and actual performance may vary over time. Rectron Inc does not assume any liability arising out of the application or use of any product or circuit.

Rectron products are not designed, intended or authorized for use in medical, life-saving implant or other applications intended for life-sustaining or other related applications where a failure or malfunction of component or circuitry may directly or indirectly cause injury or threaten a life without expressed written approval of Rectron Inc. Customers using or selling Rectron components for use in such applications do so at their own risk and shall agree to fully indemnify Rectron Inc and its subsidiaries harmless against all claims, damages and expenditures.