

FAN5358 2MHz, 500mA, SC70 Synchronous Buck Regulator

Features

- 2MHz Nominal-Frequency Operation
- 25µA Typical Quiescent Current
- 500mA Output Current Capability
- 2.7V to 5.5V Input Voltage Range
- 1.0 to 1.8V Fixed Output Voltages
- Low Ripple, Light-Load PFM Mode
- Internal Soft-Start
- Input Under-Voltage Lockout (UVLO)
- Thermal Shutdown and Overload Protection
- 6-lead 2 x 2.2mm SC70

Applications

- Cell Phones, Smart Phones
- 3G, 4G, WiFi®, WiMAX™, and WiBro® Data Cards
- Netbooks®, Ultra-Mobile PCs

Description

The FAN5358 is a step-down switching voltage regulator that delivers a fixed output from an input voltage supply of 2.7V to 5.5V. Using a proprietary architecture with synchronous rectification, the device is capable of delivering 500mA and maintaining a very high efficiency of over 80% at load currents as low as 1mA. The regulator operates at a nominal frequency of 2MHz, which reduces the value of the external components to as low as 2.2µH for the output inductor and 4.7µF for the output capacitor.

At moderate and light loads, pulse frequency modulation is used to operate the device in power-save mode with a typical quiescent current of 25µA. Even with such a low quiescent current, the part exhibits excellent transient response during large load swings. In shutdown mode, the supply current drops below 1µA, reducing power consumption.

FAN5358 is available in a 6-lead SC70 package.

Typical Application

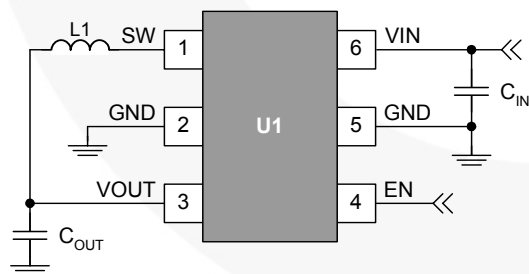

Figure 1. FAN5358 Typical Application

Table 1. External Components for Figure 1

U1	f _{sw}	L1	C _{IN}	C _{OUT}
FAN5358	2MHz	2.2µH	2.2µF	4.7µF

Trademarks are the property of their respective owners.

Ordering Information

Part Number	Switching Frequency	Output Voltage ⁽¹⁾	Temperature Range	Package	Packing Method
FAN5358S710X	2MHz	1.0V	-40 to +85°C	SC70-6	Tape and Reel
FAN5358S712X		1.2V			
FAN5358S713X		1.3V			
FAN5358S718X		1.8V			

Note:

- Other voltage options are available on request. Contact a Fairchild representative.

Pin Configuration

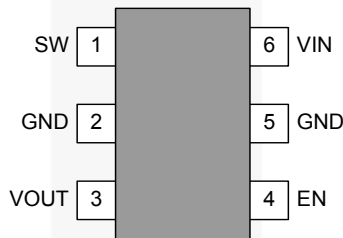

Figure 2. Pin Assignments (Top View)

Pin Definitions

Pin #	Name	Description
1	SW	Switching Node. Connect to output inductor.
2, 5	GND	Ground. Power and IC ground. All signals are referenced to this pin.
3	VOUT	V_{OUT} / Feedback. Connect to output voltage.
4	EN	Enable. The device is in shutdown mode when the voltage to this pin is <0.4V and enabled when >1.2V. Do not leave this pin floating.
6	VIN	Input Voltage. Connect to input power source and C _{IN} .

Absolute Maximum Ratings

Stresses exceeding the absolute maximum ratings may damage the device. The device may not function or be operable above the recommended operating conditions and stressing the parts to these levels is not recommended. In addition, extended exposure to stresses above the recommended operating conditions may affect device reliability. The absolute maximum ratings are stress ratings only.

Symbol	Parameter	Min.	Max.	Units
V_{IN}	Input Voltage with Respect to GND	-0.3	6.0	V
	Voltage on Any Other Pin with Respect to GND	-0.3	$V_{IN} + 0.3V^{(2)}$	V
T_J	Junction Temperature	-40	+150	°C
T_{STG}	Storage Temperature	-65	+150	°C
T_L	Lead Temperature (Soldering 10 Seconds)		+260	°C
ESD	Electrostatic Discharge Protection Level	Human Body Model, JESD22-A114	2	kV
		Charged Device Model, JESD22-C101	1	

Note:

- Lesser of 6.0V or $V_{IN} + 0.3V$

Recommended Operating Conditions

The Recommended Operating Conditions table defines the conditions for actual device operation. Recommended operating conditions are specified to ensure optimal performance to the datasheet specifications. Fairchild does not recommend exceeding them or designing to Absolute Maximum Ratings.

Symbol	Parameter	Min.	Typ.	Max.	Units
V_{CC}	Supply Voltage Range	2.7		5.5	V
I_{OUT}	Output Current	0		500	mA
L	Inductor		2.2		μH
C_{IN}	Input Capacitor		2.2		μF
C_{OUT}	Output Capacitor ⁽³⁾		4.7		μF
T_A	Operating Ambient Temperature	-40		+85	°C
T_J	Operating Junction Temperature	-40		+125	°C

Thermal Properties

Symbol	Parameter	Min.	Typ.	Max.	Units
Θ_{JA}	Junction-to-Ambient Thermal Resistance ⁽⁴⁾		285		°C/W

Notes:

- Refer to Operation Description section for guidance on maximum C_{OUT} capabilities.
- Junction-to-ambient thermal resistance is a function of application and board layout. This data is measured with four-layer 2s2p boards in accordance to JESD51- JEDEC standard. Special attention must be paid not to exceed junction temperature $T_{J(max)}$ at a given ambient temperature T_A .

Electrical Characteristics

Minimum and maximum values are at $V_{IN} = 2.7V$ to $5.5V$, $T_A = -40^{\circ}C$ to $+85^{\circ}C$, circuit of Figure 1 unless otherwise noted. Typical values are at $T_A = 25^{\circ}C$, $V_{IN} = 3.6V$.

Symbol	Parameter	Conditions	Min.	Typ.	Max.	Units	
Power Supplies							
I_Q	Quiescent Current	No Load, $EN = V_{IN}$		25	48	μA	
I_{SD}	Shutdown Supply Current	$EN = GND$		0.05	1.00	μA	
V_{UVLO}	Under-Voltage Lockout Threshold	Rising V_{IN}		2.4	2.6	V	
V_{UVHYS}	Under-Voltage Lockout Hysteresis			225		mV	
$V_{(ENH)}$	Enable HIGH-Level Input Voltage		1.2			V	
$V_{(ENL)}$	Enable LOW-Level Input Voltage				0.4	V	
$I_{(EN)}$	Enable Input Leakage Current	$EN = V_{IN}$ or GND		0.01	1.00	μA	
Oscillator							
f_{OSC}	Switching Frequency	In PWM Mode		2		MHz	
Regulation							
V_O	Output Voltage Accuracy	1.0V	$I_{LOAD} = 0$ to 500mA	-4.5		+4.5	%
		1.2V	$I_{LOAD} = 0$ to 500mA	-4.5		+4.5	
		1.3V	$I_{LOAD} = 0$ to 500mA	-4.5		+4.5	
		1.8V	$I_{LOAD} = 0$ to 500mA	-4.0		+4.0	
t_{SS}	Soft-Start	From EN Rising Edge		70		μs	
Output Driver							
$R_{DS(on)}$	PMOS On Resistance	$V_{IN} = V_{GS} = 3.6V$		750		$m\Omega$	
	NMOS On Resistance	$V_{IN} = V_{GS} = 3.6V$		650		$m\Omega$	
I_{LIM}	PMOS Peak Current Limit	Open-Loop ⁽¹⁾	750	850	1150	mA	
T_{TSD}	Thermal Shutdown			150		$^{\circ}C$	
T_{HYS}	Thermal Shutdown Hysteresis			20		$^{\circ}C$	

Note:

5. The Electrical Characteristics table reflects open-loop data. Refer to Operation Description and Typical Characteristic for closed-loop data.

Block Diagram

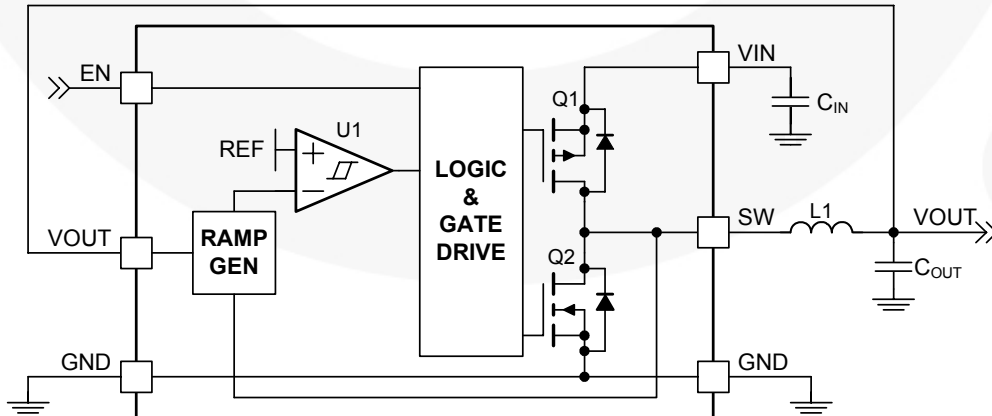

Figure 3. IC Block Diagram

Typical Characteristics

Unless otherwise noted, $V_{IN} = V_{EN} = 3.6V$, $V_{OUT} = 1.8V$, and $T_A = 25^\circ C$.

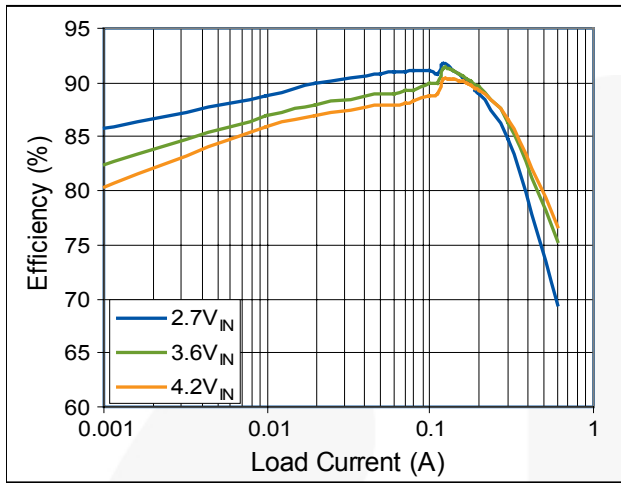

Figure 4. Efficiency vs. Load Current and Input Supply

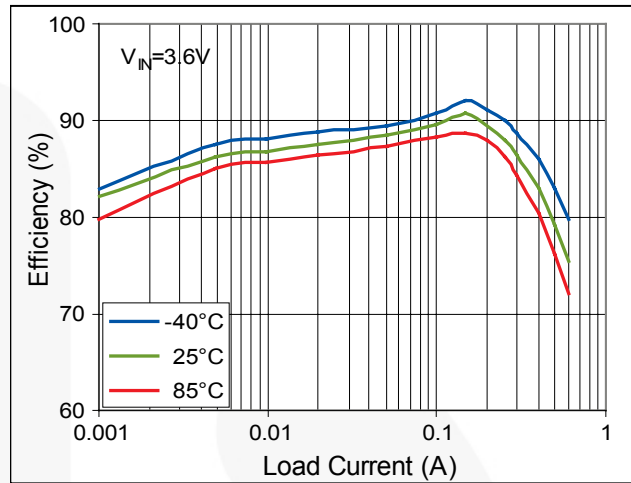

Figure 5. Efficiency vs. Load Current and Temperature

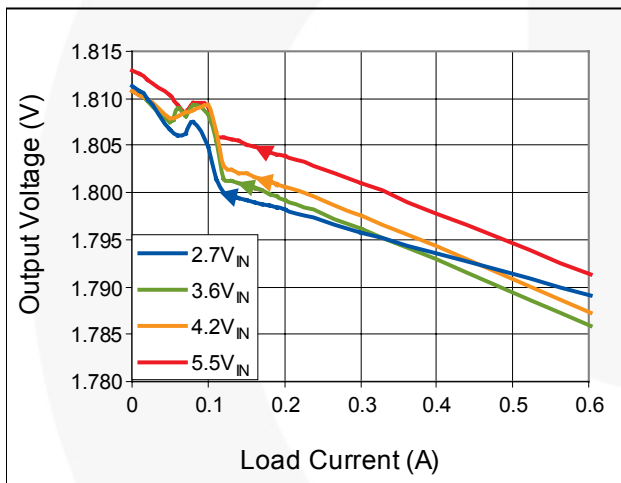

Figure 6. Voltage Regulation

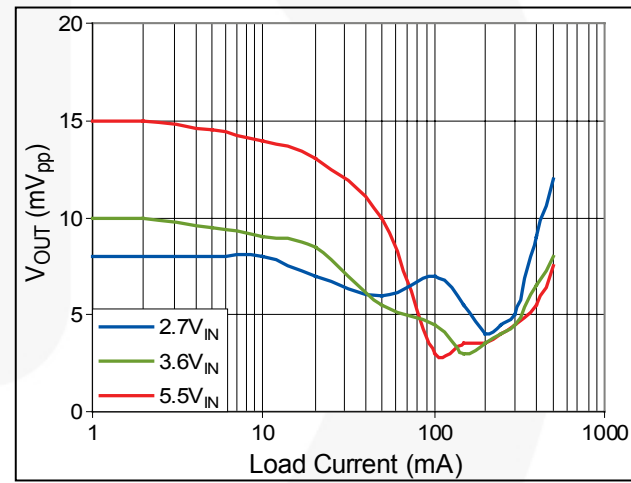

Figure 7. Peak-to-Peak Output Voltage Ripple

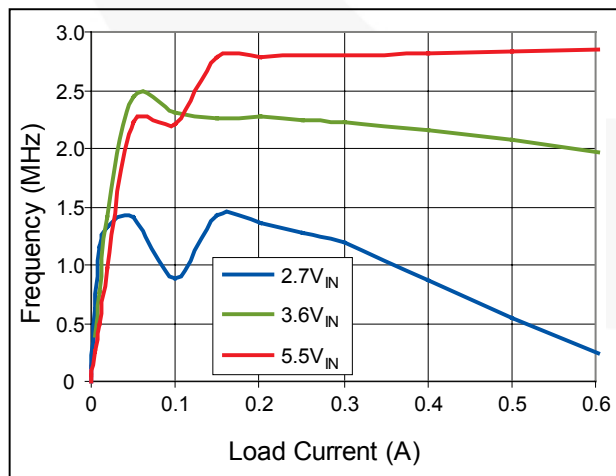

Figure 8. Switching Frequency vs. Load Current

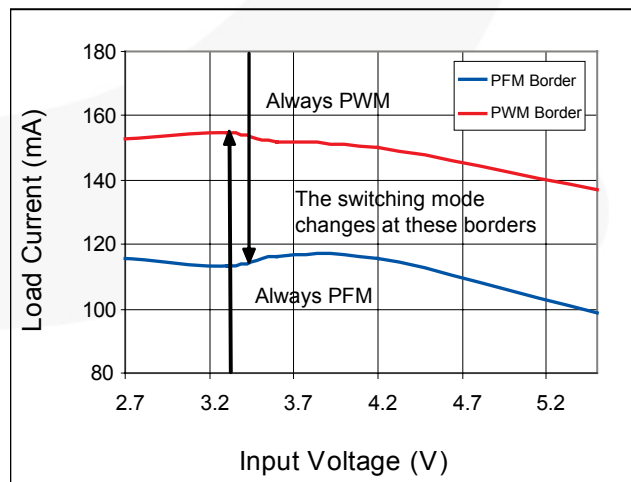

Figure 9. PFM / PWM Boundaries

Typical Characteristics

Unless otherwise noted, $V_{IN} = V_{EN} = 3.6V$, $V_{OUT} = 1.8V$, and $T_A = 25^\circ C$.

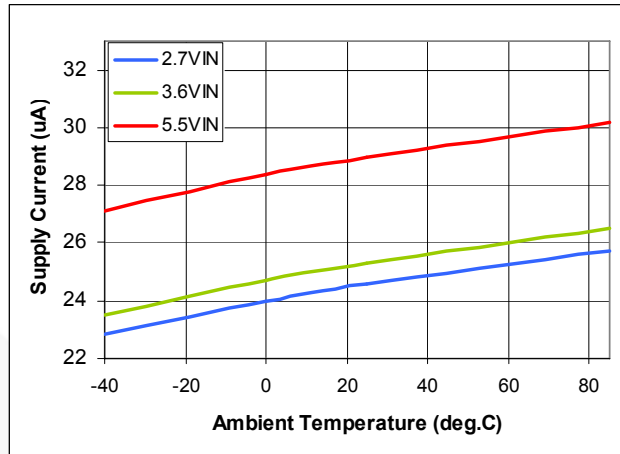

Figure 10. Quiescent Current vs. Input Voltage and Temperature



Figure 11. Line Transient 3.3V_{IN} to 3.9V_{IN}, 50mA Load, 10µs/div.

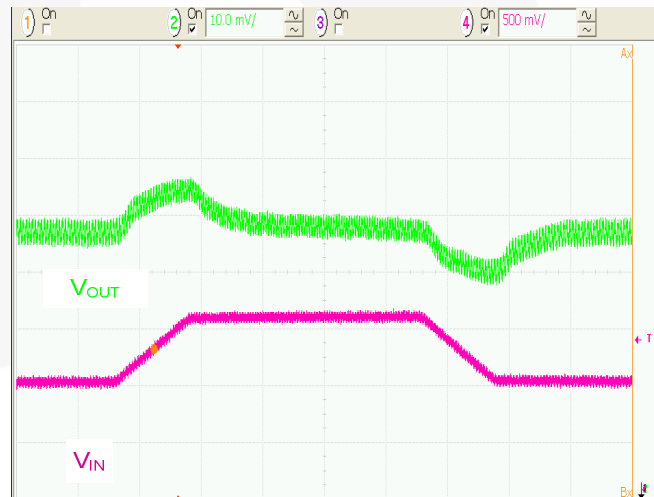

Figure 12. Line Transient 3.3V_{IN} to 3.9V_{IN}, 250mA Load, 10µs/div.

Typical Characteristics

Unless otherwise noted, $V_{IN} = V_{EN} = 3.6V$, $V_{OUT} = 1.8V$, and $T_A = 25^\circ C$.

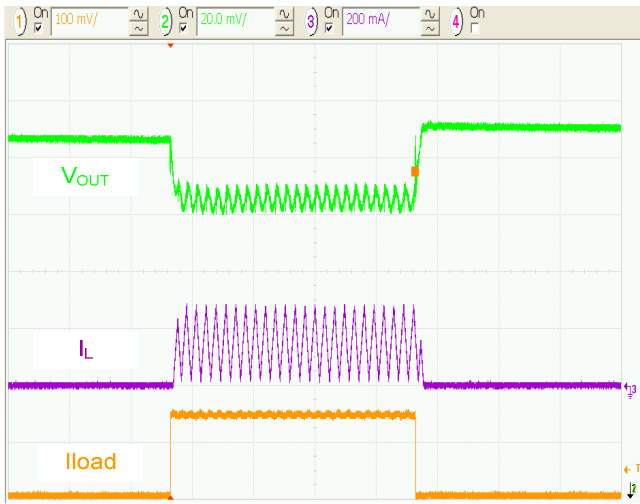

Figure 13. Load Transient 0 to 150mA, 3.6V_{IN}, 5 μs /div.

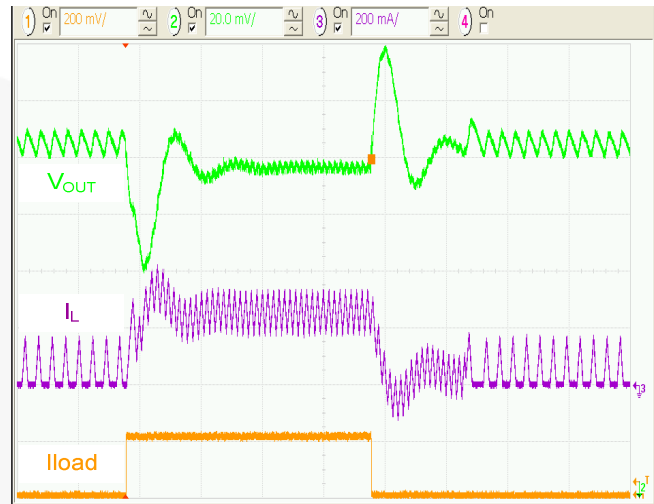

Figure 14. Load Transient 50 to 250mA, 3.6V_{IN}, 5 μs /div.

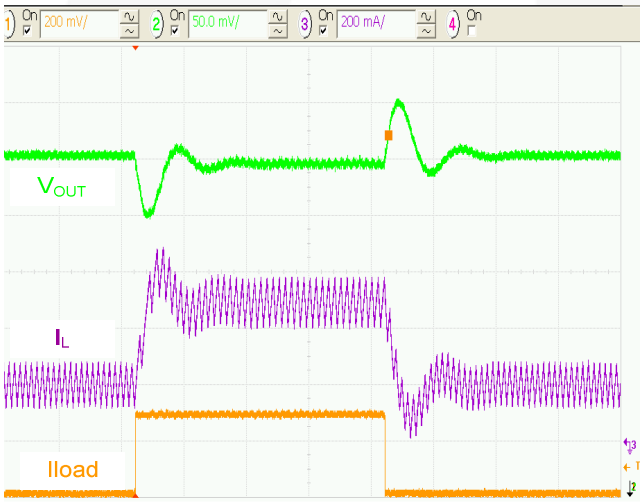

Figure 15. Load Transient 200 to 500mA, 3.6V_{IN}, 5 μs /div.



Figure 16. Metallic Short Applied at V_{OUT} , 50 μs /div.

Typical Characteristics

Unless otherwise noted, $V_{IN} = V_{EN} = 3.6V$, $V_{OUT} = 1.8V$, and $T_A = 25^\circ C$.

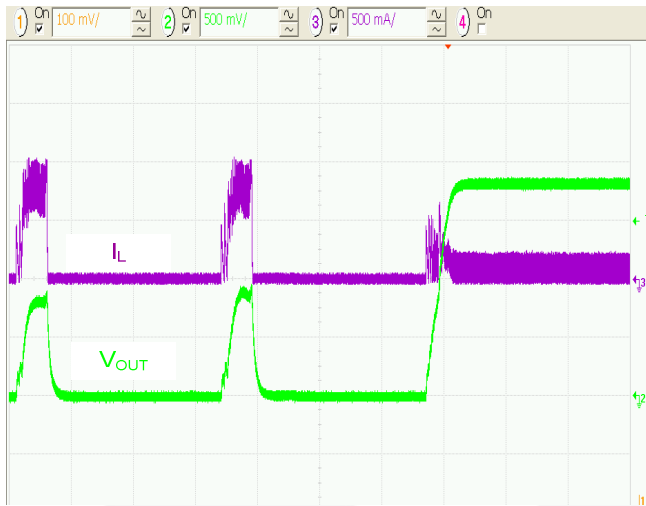

Figure 17. Overload Recovery to Light Load, 100 μ s/div.



Figure 18. Soft-Start, $R_{LOAD} = 6\Omega$, 20 μ s/div.

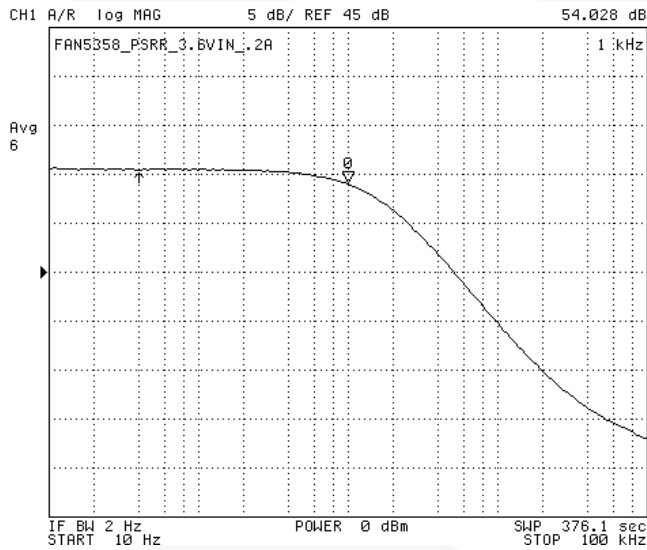

Figure 19. Power Supply Rejection Ratio at 200mA Load

Operation Description

The FAN5358 is a step-down switching voltage regulator that delivers a fixed output from an input voltage supply of 2.7V to 5.5V. Using a proprietary architecture with synchronous rectification, the device is capable of delivering 500mA and maintaining a very high efficiency of over 80% at load currents as low as 1mA. The regulator operates at a nominal frequency of 2MHz, which reduces the value of the external components to as low as 2.2 μ H for the output inductor and 4.7 μ F for the output capacitor.

Control Scheme

The FAN5358 uses a proprietary, non-linear, quasi fixed-frequency PWM modulator to deliver a fast load transient response, while maintaining a nominal switching frequency over a wide range of load conditions. The regulator performance is independent of the output capacitor ESR, allowing the use of ceramic output capacitors.

For very light loads, the device operates in discontinuous current (DCM) single-pulse PFM mode, which produces low output ripple compared with other PFM architectures. Transition between PWM and PFM is near seamless, exhibiting very little V_{OUT} glitch.

Combined with exceptional transient response characteristics, the very low quiescent current of the controller (25 μ A) maintains high efficiency, even at very light loads, while preserving fast transient response for applications requiring very tight output regulation.

Enable and Soft Start

Maintaining the EN pin LOW keeps the FAN5358 in non-switching mode in which all circuits are off and the part draws ~50nA of current. Increasing EN above its threshold voltage activates the part and starts the soft-start cycle. During soft start, the output is ramped using a slow RC time constant. This minimizes any large surge currents on the input and prevents any overshoot of the output voltage. Current limit is enforced in case the output cannot keep pace with the reference or in case of a shorted output.

The current-limit fault response protects the IC in the event of an over-current condition present during soft-start. This protection can cause the IC to fail to start if heavy load is applied during startup or if excessive C_{OUT} is used.

Table 2 shows combinations of C_{OUT} that allow the IC to start successfully with the minimum R_{LOAD} that can be supported.

Table 2. Minimum R_{LOAD} Values for Soft-Start with Various C_{OUT} Values

C_{OUT}	Minimum R_{LOAD}
4.7 μ F	No restriction
10 μ F	$V_{OUT} / 0.40$

Under-Voltage Lockout (UVLO)

When EN is HIGH, the under-voltage lockout keeps the part from operating until the input supply voltage rises high enough to properly operate. This ensures no misbehavior of the regulator during startup or shutdown.

Current Limiting

A heavy load or short circuit on the output causes the current in the inductor to increase until a maximum current threshold is reached in the high-side switch. Upon reaching this point, the high-side switch turns off, preventing current from increasing further.

After 12 consecutive PWM cycles that terminate in current limit, the IC shuts down. About 275 μ s after shutting down, the IC attempts to restart. If the fault has not cleared, the IC continues to shut down, then attempts to restart as shown in Figure 16.

Thermal Shutdown

When the die temperature increases, due to a heavy load condition and/or high ambient temperature, output switching is disabled until the die temperature falls sufficiently. The junction temperature at which the thermal shutdown activates is nominally 150 $^{\circ}$ C with a 20 $^{\circ}$ C hysteresis. Upon cooling, the output is enabled and goes through the regular soft start.

Applications Information

Selecting the Inductor

The output inductor must meet both the required inductance and the energy handling capability of the application.

The inductor value affects the average current limit, the PWM-to-PFM transition point, the output voltage ripple, and the efficiency.

The ripple current (ΔI) of the regulator is:

$$\Delta I \approx \frac{V_{OUT}}{V_{IN}} \cdot \left(\frac{V_{IN} - V_{OUT}}{L \cdot f_{SW}} \right) \quad (1)$$

The maximum average load current, $I_{MAX(Load)}$, is related to the peak current limit, $I_{LIM(PK)}$ by the ripple current:

$$I_{MAX(Load)} = I_{LIM(PK)} - \frac{\Delta I}{2} \quad (2)$$

The transition between PFM and PWM operation is determined by the point at which the inductor valley current crosses zero. The regulator DC current when the inductor current crosses zero, I_{DCM} , is:

$$I_{DCM} = \frac{\Delta I}{2} \quad (3)$$

The FAN5358 is optimized for operation with $L=2.2\mu H$. The inductor should be rated to maintain at least 70% of its value at $I_{LIM(PK)}$.

Efficiency is affected by the inductor DCR and inductance value. Decreasing the inductor value for a given physical size typically decreases the DCR; but since ΔI increases, the RMS current increases, as do core and skin effect losses.

$$I_{RMS} = \sqrt{I_{OUT(DC)}^2 + \frac{\Delta I^2}{12}} \quad (4)$$

The increased RMS current produces higher losses through the $R_{DS(ON)}$ of the IC MOSFETs as well as the inductor ESR.

Increasing the inductor value produces lower RMS currents, but degrades transient response. For a given physical inductor size, increased inductance usually results in an inductor with lower saturation current. Table 3 shows the effects of inductance higher or lower than the recommended inductor on regulator performance.

Thermal Considerations

The FAN5358 is designed to supply a maximum of 500mA, at the specified output voltage, with an operating junction temperature of up to 125°C. Once the power dissipation and thermal resistance is known, the maximum junction temperature of the device can be calculated. The power dissipation by the IC can be calculated from the power efficiency diagram Figure 5 and subtracting the power dissipated by the inductor due to its serial resistance (ESR).

The inductor ESR is dependent, not only upon the size and type of inductor, but also upon the switching frequency, which depends on the load and V_{IN} . Some inductor manufacturers provide full information regarding the variation of the inductor ESR with the switching frequency. This information can be used to show that, at high switching frequency (~2 MHz) and maximum load, the power dissipated by the inductor can exceed the power dissipated by the IC package itself.

The actual thermal resistance depends upon the thermal characteristics of the SC-70 surface-mount package and the surrounding printed circuit board (PCB) copper to which it is mounted. This can be improved by providing a heat sink of surrounding copper ground on the PCB. Depending on the size of the copper area, the resulting θ_{JA} can be reduced below 280°C/W. The addition of backside copper with through holes, stiffeners, and other enhancements can also help reduce thermal resistance. The heat contributed by the dissipation of other devices, particularly the inductor, located nearby, must be included in the design considerations. Once the limiting parameters are determined, the design can be modified to ensure that the device remains within specified operating conditions even if the maximum load is applied permanently.

In short circuit V_{OUT} -to-GND condition, the FAN5358 is fully protected and the power dissipated is internally reduced below 100mW. Overload conditions at minimum V_{IN} should be considered as worst case, when it is possible for the device to enter a thermal cycling loop in which the circuit enters a shutdown condition, cools, re-enables, and again overheats and shuts down repeatedly due to an unmanaged fault condition. The diagram in Figure 20 was determined experimentally, using the recommended two-layer PCB in still air, to be used as a thermal guide.

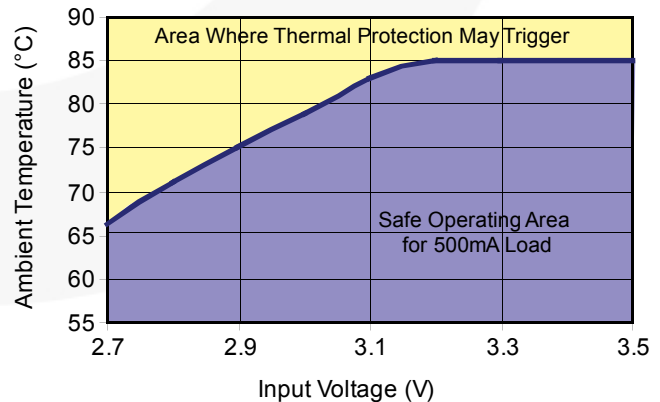

Figure 20. Maximum Ambient Temperature vs. Input Voltage at 500mA

PCB Layout Considerations

There are only three external components: the inductor and the input and output capacitors. For any buck regulator IC, including the FAN5358, it is important to place a low-ESR input capacitor very close to the IC, as shown in Figure 21. The input capacitor ensures good input decoupling, which reduces noise appearing at the output terminals and ensures that the control sections of the IC do not behave erratically due to excessive noise. This reduces switching cycle jitter and ensures good overall performance. It is important to place the common GND of C_{IN} and C_{OUT} as close as possible to any of the FAN5358 GND terminals. There is some flexibility in moving the inductor further away from the IC; in that case, V_{OUT} should be considered at the C_{OUT} terminal.

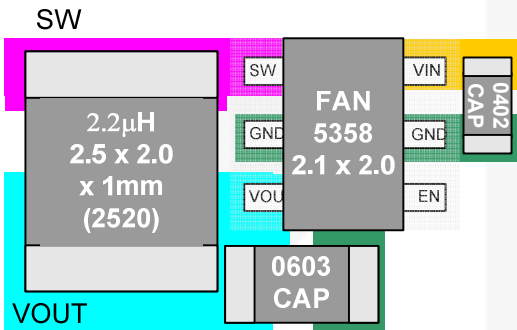

Figure 21. PCB Layout Guidance

Output Capacitor

Table 4 suggests 0402 capacitors. 0603 capacitors may further improve performance in that the effective capacitance is higher. This improves the transient response and output ripple as shown in Table 3.

Increasing C_{OUT} has no effect on loop stability and can therefore be increased to reduce output voltage ripple or to improve transient response. Output voltage ripple, ΔV_{OUT}, is:

$$\Delta V_{OUT} = \Delta I \cdot \left(\frac{1}{8 \cdot C_{OUT} \cdot f_{SW}} + ESR \right) \quad (5)$$

Input Capacitor

The 2.2µF ceramic input capacitor should be placed as close as possible between the VIN pin and GND to minimize the parasitic inductance. If a long wire is used to bring power to the IC, additional “bulk” capacitance (electrolytic or tantalum) should be placed between C_{IN} and the power source lead to reduce ringing that can occur between the inductance of the power source leads and C_{IN}.

The effective capacitance value decreases as VIN increases due to DC Bias effects. This has no significant impact on regulator performance.

Table 3. Effects of Changes in Inductor Value (from Recommended Value) on Regulator Performance

Inductor Value	I _{MAX(LOAD)}	I _{LIM(PK)}	ΔV _{OUT} ⁽⁵⁾	Transient Response
Increase	Increase	Decrease	Decrease	Degraded
Decrease	Decrease	Increase	Increase	Improved

Table 4. Recommended Passive Components and Their Variation Due to DC Bias

Component	Description	Vendor	Min.	Typ.	Max.	Comment
L1	2.2µH, 2520, 100mΩ, 1.3A	FDK MIPF2520D	1.5µH	2.2µH		Minimum value occurs at maximum current
	2.2µH, 2520, 80mΩ, 1.3A	Hitachi Metal:KSLI - 252010AG-2R2 Murata: LQM31PN2RM00L TOKO: MDT2520CN2R2M				
C _{OUT}	4.7µF, X5R, 0402	Murata or Equivalent GRM155R60G475M GRM155R60E475ME760	1.6µF	4.7µF	5.2µF	Decrease primarily due to DC bias (V _{OUT})
C _{IN}	2.2µF, X5R, 0402	Murata or Equivalent GRM155R60J225ME15 GRM188R60J225KE19D	1.0µF	2.2µF	2.4µF	Decrease primarily due to DC bias (V _{IN}) and elevated temperature

Physical Dimensions

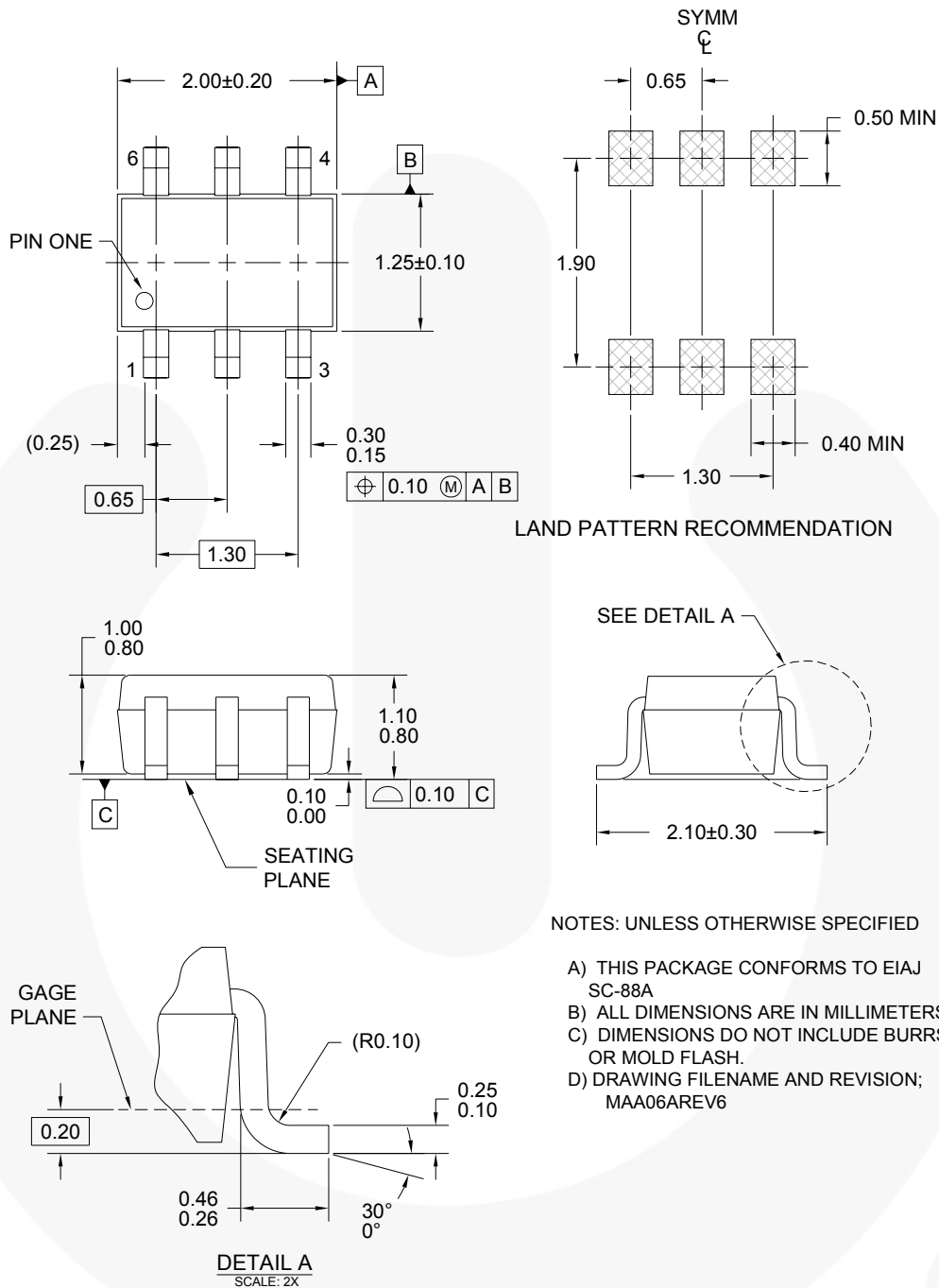

Figure 22. 6-Lead SC70

Package drawings are provided as a service to customers considering Fairchild components. Drawings may change in any manner without notice. Please note the revision and/or date on the drawing and contact a Fairchild Semiconductor representative to verify or obtain the most recent revision. Package specifications do not expand the terms of Fairchild's worldwide terms and conditions, specifically the warranty therein, which covers Fairchild products.

Always visit Fairchild Semiconductor's online packaging area for the most recent package drawings:
<http://www.fairchildsemi.com/packaging/>.





TRADEMARKS

The following includes registered and unregistered trademarks and service marks, owned by Fairchild Semiconductor and/or its global subsidiaries, and is not intended to be an exhaustive list of all such trademarks.

AccuPower™
Auto-SPM™
Build it Now™
CorePLUS™
CorePOWER™
CROSSVOLT™
CTL™
Current Transfer Logic™
DEUXPEED®
Dual Cool™
EcoSPARK®
EfficientMax™
ESBC™
F®
Fairchild®
Fairchild Semiconductor®
FACT Quiet Series™
FACT®
FAST®
FastvCore™
FETBench™
FlashWriter®
FPS™

F-PFS™
FRFET®
Global Power Resource™
Green FPS™
Green FPST™ e-Series™
Gmax™
GTO™
IntelliMAX™
ISOPLANAR™
MegaBuck™
MICROCOUPLER™
MicroFET™
MicroPak™
MicroPak2™
MillerDrive™
MotionMax™
Motion-SPM™
OptoHit™
OPTOLOGIC®
OPTOPLANAR®

PDP SPM™

Power-SPM™
PowerTrench®
PowerXS™
Programmable Active Droop™
QFET®
QS™
Quiet Series™
RapidConfigure™

Saving our world, 1mW/W/kW at a time™
SignalWise™
SmartMax™
SMART START™
SPM®
STEALTH™
SuperFET®
SuperSOT™-3
SuperSOT™-6
SuperSOT™-8
SupreMOS®
SyncFET™
Sync-Lock™

SYSTEM GENERAL
The Power Franchise®
the power franchise
TinyBoost™
TinyBuck™
TinyCalc™
TinyLogic®
TINYOPTO™
TinyPower™
TinyPWM™
TinyWire™
TriFault Detect™
TRUECURRENT™*
μSerDes™

UHC®
Ultra FRFET™
UniFET™
VCX™
VisualMax™
XS™

* Trademarks of System General Corporation, used under license by Fairchild Semiconductor.

DISCLAIMER

FAIRCHILD SEMICONDUCTOR RESERVES THE RIGHT TO MAKE CHANGES WITHOUT FURTHER NOTICE TO ANY PRODUCTS HEREIN TO IMPROVE RELIABILITY, FUNCTION, OR DESIGN. FAIRCHILD DOES NOT ASSUME ANY LIABILITY ARISING OUT OF THE APPLICATION OR USE OF ANY PRODUCT OR CIRCUIT DESCRIBED HEREIN; NEITHER DOES IT CONVEY ANY LICENSE UNDER ITS PATENT RIGHTS, NOR THE RIGHTS OF OTHERS. THESE SPECIFICATIONS DO NOT EXPAND THE TERMS OF FAIRCHILD'S WORLDWIDE TERMS AND CONDITIONS, SPECIFICALLY THE WARRANTY THEREIN, WHICH COVERS THESE PRODUCTS.

LIFE SUPPORT POLICY

FAIRCHILD'S PRODUCTS ARE NOT AUTHORIZED FOR USE AS CRITICAL COMPONENTS IN LIFE SUPPORT DEVICES OR SYSTEMS WITHOUT THE EXPRESS WRITTEN APPROVAL OF FAIRCHILD SEMICONDUCTOR CORPORATION.

As used herein:

1. Life support devices or systems are devices or systems which, (a) are intended for surgical implant into the body or (b) support or sustain life, and (c) whose failure to perform when properly used in accordance with instructions for use provided in the labeling, can be reasonably expected to result in a significant injury of the user.
2. A critical component in any component of a life support, device, or system whose failure to perform can be reasonably expected to cause the failure of the life support device or system, or to affect its safety or effectiveness.

ANTI-COUNTERFEITING POLICY

Fairchild Semiconductor Corporation's Anti-Counterfeiting Policy. Fairchild's Anti-Counterfeiting Policy is also stated on our external website, www.fairchildsemi.com, under Sales Support.

Counterfeiting of semiconductor parts is a growing problem in the industry. All manufacturers of semiconductor products are experiencing counterfeiting of their parts. Customers who inadvertently purchase counterfeit parts experience many problems such as loss of brand reputation, substandard performance, failed applications, and increased cost of production and manufacturing delays. Fairchild is taking strong measures to protect ourselves and our customers from the proliferation of counterfeit parts. Fairchild strongly encourages customers to purchase Fairchild parts either directly from Fairchild or from Authorized Fairchild Distributors who are listed by country on our web page cited above. Products customers buy either from Fairchild directly or from Authorized Fairchild Distributors are genuine parts, have full traceability, meet Fairchild's quality standards for handling and storage and provide access to Fairchild's full range of up-to-date technical and product information. Fairchild and our Authorized Distributors will stand behind all warranties and will appropriately address any warranty issues that may arise. Fairchild will not provide any warranty coverage or other assistance for parts bought from Unauthorized Sources. Fairchild is committed to combat this global problem and encourage our customers to do their part in stopping this practice by buying direct or from authorized distributors.

PRODUCT STATUS DEFINITIONS

Definition of Terms

Datasheet Identification	Product Status	Definition
Advance Information	Formative / In Design	Datasheet contains the design specifications for product development. Specifications may change in any manner without notice.
Preliminary	First Production	Datasheet contains preliminary data; supplementary data will be published at a later date. Fairchild Semiconductor reserves the right to make changes at any time without notice to improve design.
No Identification Needed	Full Production	Datasheet contains final specifications. Fairchild Semiconductor reserves the right to make changes at any time without notice to improve the design.
Obsolete	Not In Production	Datasheet contains specifications on a product that is discontinued by Fairchild Semiconductor. The datasheet is for reference information only.

Rev. 150